

Roope Tanner

## **Handover performance evaluation between 450 MHz and 2600 MHz LTE networks**

**School of Electrical Engineering**

Thesis submitted for examination for the degree of Master of  
Science in Technology.

Espoo 10.10.2016

**Thesis supervisor:**

Prof. Heikki Hämmäinen

**Thesis advisor:**

M.Sc. (Tech.) Kari Lehtinen

Author: Roope Tanner		
Title: Handover performance evaluation between 450 MHz and 2600 MHz LTE networks		
Date: 10.10.2016	Language: English	Number of pages: 9+65
Department of Communications and Networking		
Professorship: Network Economics	Code: S-38	
Supervisor: Prof. Heikki Hämmäinen		
Advisor: M.Sc. (Tech.) Kari Lehtinen		
<p>This thesis evaluates handover performance between two different LTE frequency bands, band 31 and band 38, which are operated on 450 MHz and 2600 MHz frequencies, respectively. Mobile network operators are deploying multiple LTE frequency bands within same geographical areas in order to meet demand created by continuously growing mobile data usage. This creates additional challenges to network design, performance optimization and mobility management. Studied bands 31 and 38 differ on their propagation characteristics, as well as on their specified transmission capabilities. Bands also utilize different duplex methods, Frequency Division Duplex and Time Division Duplex. Performance evaluation was conducted in order to allow efficient usage of both bands.</p> <p>Evaluation is based on information obtained from 3GPP specifications and laboratory measurements conducted with commercially available equipment. Current handover parameters of the studied network have been optimized for 450 MHz cells only, and utilize mostly default configurations introduced by device manufacturer. This configuration is evaluated and more suitable handover strategy is proposed. The proposed strategy is then compared with the default strategy through measurements conducted in laboratory environment.</p> <p>Conducted measurements confirm that with proper handover parameter optimization, 2600 MHz frequency band can be prioritized over less capable 450 MHz band, which is likely to improve user perceived service quality. By utilizing collected results, associated network operator could improve offered services and gain savings in network equipment costs.</p>		
Keywords: LTE, Handover, Mobility, Key Performance Indicators, Parameter optimization		

Tekijä: Roope Tanner		
Työn nimi: Solunvaihdon suorituskyvyn arviointi 450 MHz ja 2600 MHz LTE-verkkojen välillä		
Päivämäärä: 10.10.2016	Kieli: Englanti	Sivumäärä: 9+65
Tietoliikenne- ja tietoverkkotekniikan laitos		
Professuuri: Tietoverkkotalous		Koodi: S-38
Valvoja: Prof. Heikki Hämmäinen		
Ohjaaja: DI Kari Lehtinen		
<p>Tässä diplomityössä tutkitaan solunvaihdon suorituskykyä kahden LTE-taajuuskaistan, 31 ja 38, välillä. Taajuuskaistaa 31 operoidaan 450 MHz taajuudella ja taajuuskaistaa 38 2600 MHz taajuudella. Vastatakseen jatkuvaan mobiilidatan käytön kasvuun, verkko-operaattorit ottavat käyttöön useita LTE-taajuuksia saman maantieteellisen alueen sisällä. Tämä luo ylimääräisiä haasteita verkkosuunniteluun, verkon suorituskyvyn optimointiin ja mobiliteetin hallintaan. Tutkitut taajuuskaistat eroavat niin etenemis-, kuin tiedonsiirtokyvyltään. Lisäksi taajuuskaistat käyttävät erilaisia duplex-muotoja. Suorituskyvyn arvioinnin tarkoitus on mahdollistaa molempien taajuuskaistojen tehokas käyttö. Suorituskyvyn arviointi perustuu 3GPP:n spesifikaatioihin ja kaupallisella laitteistolla suoritettuihin laboratoriomittauksiin. Nykyisin käytössä olevat verkkoparametrit on optimoitu vain 450 MHz solujen käyttöön, jonka lisäksi suuri osa verkon konfiguraatioista hyödyntää valmistajan käyttämiä oletusarvoja. Työssä verkon konfiguraatiolla suoritetaan arviointi, jonka perusteella esitetään suositeltu solunvaihdon strategia. Suositeltua strategiaa verrataan oletus-strategiaan laboratoriomittausten avulla.</p> <p>Mittaustulokset näyttävät toteen, että oikeanlaisilla solunvaihdon parametreilla 2600 MHz taajuuskaistaa voidaan priorisoida heikomman 450 MHz taajuuskaistan yli. Monissa tilanteissa tämä parantaa käyttäjien verkosta saamaa palvelukokemusta. Hyödyntämällä tämän työn tuottamia tuloksia, verkko-operaattori voi parantaa tarjoamaansa palvelua ja saavuttaa säästöjä laitehankinnoissa.</p>		
Avainsanat: LTE, Solunvaihto, Mobiliteetti, Suorituskyvyn mittarit, Parametrien optimointi		

## Preface

This thesis and related measurements are based on LTE network of Ukkoverkot Oy. Therefore I would like to thank Kari Lehtinen and Jari Weckman for offering me the opportunity to write this thesis. Special thanks to Kari and Joel for their guidance and encouragement during the project.

I would also like to thank Prof. Heikki Hämmäinen for his guidance and advices during the process.

Finally, I would like to thank my family and Mari for their continuous support and encouragement.

Helsinki, 10.10.2016

Roope O. Tanner

# Contents

<b>Abstract</b>	<b>ii</b>
<b>Abstract (in Finnish)</b>	<b>iii</b>
<b>Preface</b>	<b>iv</b>
<b>Abbreviations</b>	<b>vii</b>
<b>1 Introduction</b>	<b>1</b>
1.1 Research problem . . . . .	1
1.2 Research scope . . . . .	2
1.3 Research method . . . . .	2
1.4 Thesis structure . . . . .	3
<b>2 Evolved Packet System</b>	<b>4</b>
2.1 Standardization and requirements . . . . .	4
2.2 Basic network structure of EPS . . . . .	6
2.3 Signaling protocols . . . . .	9
2.4 Evolved Universal Terrestrial Radio Access Network . . . . .	11
2.4.1 Duplex schemes . . . . .	11
2.4.2 Orthogonal Frequency-Division Multiple Access . . . . .	12
2.4.3 Single Carrier Frequency-Division Multiple Access . . . . .	15
2.4.4 Multiple Input Multiple Output . . . . .	16
2.4.5 Physical layer transmission . . . . .	18
<b>3 EPS Mobility Management</b>	<b>23</b>
3.1 LTE performance indicators . . . . .	23
3.1.1 Reference Signal Receiver Power (RSRP) . . . . .	23
3.1.2 Receiver Signal Strength Indicator (RSSI) . . . . .	23
3.1.3 Reference Signal Received Quality (RSRQ) . . . . .	24
3.1.4 Signal-to-Interference-and-Noise-Ratio (SINR) . . . . .	24
3.2 UE state management . . . . .	25
3.3 Mobility management . . . . .	26
3.3.1 Idle mode mobility . . . . .	27
3.3.2 Connected mode mobility . . . . .	28
3.3.3 Signaling procedures . . . . .	30
<b>4 Mobility performance in studied LTE network</b>	<b>34</b>
4.1 Handover performance indicators . . . . .	34
4.2 Network characteristics . . . . .	35
4.3 Handover strategies . . . . .	41
4.4 Preliminary analysis . . . . .	47

<b>5</b>	<b>Performance evaluation</b>	<b>52</b>
5.1	Measurement setup . . . . .	52
5.2	Measurement results . . . . .	54
5.3	Measurement analysis . . . . .	58
<b>6</b>	<b>Conclusions</b>	<b>61</b>
6.1	Obtained results . . . . .	61
6.2	Assessment of results . . . . .	61
6.3	Applicability of results . . . . .	62
6.4	Future research . . . . .	62

## Abbreviations

3GPP	Third Generation Partnership Project
3GPP2	Third Generation Partnership Project 2
ARPU	Average Revenue Per User
AS	Access Stratum
BER	Bit Error Rate
BPSK	Binary Phase Shift Keying
CA	Carrier Aggregation
CDF	Cumulative Distribution Function
CDMA	Code Vision Multiple Access
CoMP	Coordinated MultiPoint
CP	Cyclic Prefix
CQI	Channel Quality Indicator
DCI	Downlink Control Information
DL	Downlink
ECM	EPS Connection Management
EMM	EPS Mobility Management
eNodeB	evolved Node B
EPC	Evolved Packet Core
EPS	Evolved Packet System
E-UTRAN	Evolved Universal Terrestrial Radio Access Network
FDD	Frequency Division Duplex
GP	Guard Period
GPRS	General Packet Radio Service
GSM	Global System for Mobile Communications
GSMA	GSM Association
HARQ	Hybrid Automatic Repeat Request
HetNet	Heterogeneous Network
HSDPA	High-Speed Downlink Packet Access
HSUPA	High-Speed Uplink Packet Access
ICIC	Inter-Cell Interference Coordination
IP	Internet Protocol
ISI	Inter-Symbol Interference
ITU	International Telecommunication Unit
KPI	Key Performance Indicator
L1	Layer 1
L2	Layer 2
LAN	Local Area Network
LTE	Long Term Evolution
MAC	Medium Access Control
MIB	Master Information Block
MIMO	Multiple Input Multiple Output
MME	Mobility Management Entity
NAS	Non-Access-Stratum

NMT	Nordic Mobile Telephone System
OCS	Online Charging System
OFDM	Orthogonal Frequency Division Multiplexing
OFDMA	Orthogonal Frequency-Division Multiple Access
OSI	Open Systems Interconnection
OTA	Over-The-Air
PBCH	Physical Broadcast Channel
PCFICH	Physical Control Format Indicator Channel
PCRF	Policy and Charging Rules Function
PDCCH	Physical Downlink Control Channel
PDCP	Packet Data Convergence Protocol
PDN-GW	Packet Data Network-Gateway
PDSCH	Physical Downlink Shared Channel
PGW	Packet Data Network Gateway
PHICH	Physical HARQ Indicator Channel
PLMN	Public Land Mobile Network
PMCH	Physical Multicast Channel
PRACH	Physical Random Access Channel
PRB	Physical Resource Blocks
PSS	Primary Synchronization Signal
PUCCH	Physical Uplink Control Channel
PUSCH	Physical Uplink Shared Channel
QAM	Quadrature Amplitude Modulation
QCI	QoS Class Identifier
QoS	Quality of Service
QPSK	Quadrature Phase Shift Keying
RAT	Radio Access Technology
RLC	Radio Link Control
RNC	Radio Network Controller
RRC	Radio Resource Control
RS	Reference Signal
RSRQ	Reference Signal Received Quality
RSRP	Reference Signal Received Power
RSSI	Receiver Signal Strength Indicator
S1-AP	S1 Application Protocol
SC-FDMA	Single-Carrier Frequency-Division Multiple Access
SCTP	Stream Control Transmission Protocol
SeNB	Serving eNodeB
SGW	Serving Gateway
SISO	Single Input Single Output
SIMO	Single Input Multiple Output
SNR	Signal-to-Interference-and-Noise-Ratio
SS7	Signaling System No. 7
SSS	Secondary Synchronization Signal
TA	Tracking Area



TAU	Tracking Area Update
TCP	Transmission Control Protocol
TDD	Time-Division Duplex
TDMA	Time Division Multiple Access
TeNB	Target eNodeB
TRS	Total Radiated Sensitivity
UDP	User Datagram Protocol
UE	User Equipment
UL	Uplink
USIM	Universal Subscriber Identity Module
UMTS	Universal Mobile Telecommunications System
VoIP	Voice over Internet Protocol
VoLTE	Voice over LTE
WCDMA	Wideband Code Division Multiple Access
WLAN	Wireless Local Area Network

# 1 Introduction

Ever increasing growth of mobile data usage is having an effect on mobile operator business all over the world. While demand for mobile data is growing constantly, mobile operators are forced to improve capacity and coverage of their mobile networks. These improvements are often conducted by implementing new base stations to cover yet uncovered areas, and by constructing additional capacity to existing areas. However, current technologies have limitations when coverage areas of multiple base stations are overlapping within the same geographical area: for example cells utilizing same frequencies cannot overlap without interfering with each other. This means that mobile operators have to implement different cell sizes, different frequencies and possibly different technologies in order to increase the capacity of their networks on certain areas.

Mobile operators base their networks on spectrum licenses, which define technologies and frequencies they are allowed to use. While available spectrum is considered as a scarce resource, it is important that the available spectrum is used as efficiently as possible. Using different technologies and frequencies makes mobile networks more heterogeneous, which causes additional complexity in network planning and management. Managing and planning the use of all available technologies is becoming one of the main issues when implementing new networks on top of the existing ones. With good network planning, operators can increase the overall capacity and coverage of their networks while simultaneously minimizing the costs of implementing new technologies and base stations.

## 1.1 Research problem

This thesis is done for Ukkoverkot Oy, whose Long Term Evolution (LTE) network is used as a test network during the performance evaluation. Ukkoverkot has launched its commercial LTE network utilizing two different LTE bands: Band 31 (450 MHz) and Band 38 (2600 MHz). These different bands are using two different duplex methods, which are Frequency Division Duplex (FDD) and Time-Division Duplex (TDD). The new 450MHz LTE network replaced an existing Code Division Multiple Access (CDMA) network, which existed on the same frequency band before it was migrated to LTE. Due to the nature of the migration, LTE network has seen little optimization in terms of improving radio capabilities and coverage of the network. After the migration was completed on 450 MHz network, Ukkoverkot has begun constructing 2600 MHz network in order to increase variety of offered services.

Using two different frequency bands within the same geographical area creates a challenging situation considering network mobility management and service quality. Especially handovers between these two bands are considered as challenging to optimize due to different characteristics of the bands. Since new technologies and locations have been introduced to the network, there is a clear need for measurement and optimization. This thesis evaluates the current performance of handovers between these two networks. Based on the results of initial evaluation, this thesis aims to find an answer to the following question: “How is the handover performance

between 450 MHz and 2600 MHz networks improved efficiently?”.

## 1.2 Research scope

This thesis gives a brief description considering the basic principles of LTE as a technology. This description intends to give readers a high-level understanding about LTE related network elements, protocols and terminology. Therefore, this description intentionally expands beyond the actual research scope of thesis.

The conducted study aims to create a better understanding of the handover performance between the studied frequency bands. Focus of this study is to gain theoretical knowledge and analyse the performance of handover between 450 MHz and 2600 MHz cells. In addition, conducted study aims to point out possible issues related to handover performance in studied network, while simultaneously focusing on finding ways to improve network performance with parameter and planning optimization. Many of the studied features are highly equipment bound, meaning that results are mostly applicable within the scope of the studied network. Especially characteristics of the chosen end-user equipment has a large effect on achieved performance.

Since radio network planning has been done beforehand, and majority of the network is already constructed, major changes to the studied network are not possible. Therefore, any improvements considering major physical changes like base station placements or antenna tilt adjustments are ruled out from this thesis. This thesis aims to contribute to the future network improvements projects, that might be conducted in the network.

## 1.3 Research method

This thesis is based on existing literature, including 3GPP (Third Generation Partnership Project) specifications considering LTE technology. In addition, data will be collected from the network for analysis. This data is then used when suggesting performance improvements for the network. LTE uses hard handovers to control user mobility from one base station to other. This means that radio connection to a serving base station is disconnected before new connection to a target base station is established. In order to accomplish handovers, user equipment (UE) conducts measurements to determine whether the current serving base station provides better quality service than some other base station nearby. These measurements are based on Reference Signal Received Power (RSRP) or Reference Signal Received Quality (RSRQ). When certain pre-set criteria is met, handover is triggered in order to change the base station. By altering and modifying handover related threshold values, network administrators are able to affect how and when handovers are triggered.

Statistical data of the specified signal quality indicators are gathered from the network through separate network monitoring system. With the network monitoring system, it is possible to form overall understanding considering the quality of mobility between base stations. Additional measurements will be conducted with

similar network equipment that is currently in use within the commercial network. This increases the applicability of achieved results within the studied network. Some recommendations and improvements are recognized from the analysed data.

## 1.4 Thesis structure

This thesis consists of six chapters. First chapter introduces the research problem, research scope and research method of thesis. In second chapter, basic system structure and principles of LTE are introduced together with basic standardization and requirement creation process. Third chapter discusses the mobility management execution in LTE. Important Key Performance Indicators (KPI) related to network measurement and analysis are introduced. Fourth chapter covers some basic principles of handover management and different handover strategies within the studied network. Chapter also includes a preliminary analysis, which creates the foundation for actual performance monitoring. Fifth chapter includes description of used measurement setup and achieved results. These results are then analysed and possible improvements on network configuration are suggested. In sixth chapter, conclusions are described and assessed together with applicability of the achieved results. In addition, some suggestions for possible future research topics are given.

## 2 Evolved Packet System

This chapter begins with a brief introduction to the history of mobile network technologies and related standardization processes. After that, current network structure of the Fourth Generation LTE network is described. After these introductory parts, more accurate description is given considering the air interface of LTE, which is called Evolved Universal Terrestrial Radio Access Network (E-UTRAN). Reader is assumed to have basic knowledge considering telecommunication networks and technologies, but since this thesis evaluates performance of specific LTE features, it is important to understand the larger concept behind individual phenomena discussed during this study.

### 2.1 Standardization and requirements

Mobile technologies are categorized in different generations according to their characteristics. First Generation, or 1G, technologies were developed in late 1970s or early 1980s and included mostly analog-based technologies like Nordic Mobile Telephone System (NMT), which was introduced primarily in the Nordic countries. Most of the First Generation technologies were only capable of providing limited voice services with limited spectral efficiency. [1]

In order to provide higher capacity and better voice quality, Second Generation systems were developed and introduced during early 1990s. Main difference between First and Second Generation is that Second Generation, or 2G, technologies are based on digital systems instead of analogous. Second Generation includes technologies like Time Division Multiple Access (TDMA) and Code Division Multiple Access (CDMA). One of the most known and still widely used Second Generation network is Global System for Mobile Communications (GSM), which was at first only able to provide users with circuit switched services. GSM was later enhanced with General Packet Radio Service (GPRS), which introduced packet based data traffic in mobile technologies. [1]

Further evolution of mobile technologies is based mostly on standardization made by collaboration groups called Third Generation Partnership Project (3GPP) and Third Generation Partnership Project 2 (3GPP2). These organizations are considered as collaborations of different telecommunication organizations, which are responsible for creating uniform requirements for device manufacturers and mobile operators under the scope set by International Telecommunication Unit (ITU). From these organizations, 3GPP2 has been responsible for developing CDMA based technologies, and has introduced Third Generation technology CDMA2000. 3GPP has been evolving GSM technology, which has led to introduction of Third Generation technology called Universal Mobile Telecommunications System (UMTS). UMTS is based on Wideband Code Division Multiple Access (WCDMA) radio technology, and uses 5 MHz bandwidth in order to provide users with enhanced voice and data services. WCDMA radio technology has been later introduced with various enhancements: in 2001, High-Speed Downlink Packet Access (HSDPA) brought more spectral efficiency for downlink data services and in 2005 similar enhancement to up-

link, called High-Speed Uplink Packet Access (HSUPA), was introduced. Together these technologies are called HSPA, which further evolved to HSPA+, capable of transferring 42 Mbps of data in downlink and 11 Mbps in uplink. [1]

In 2004, standardization for Fourth Generation technology began with a project called Long Term Evolution (LTE). When 3GPP began developing LTE as a standard, it was expected that LTE would provide numerous advantages when compared to technologies from previous generations. Various requirements for the development were set, and it was determined that LTE should be able to provide:

- Higher spectral efficiency when compared to previous technologies
- Very low latency
- Support for variable bandwidths
- Simple protocol architecture
- Compatibility and interoperability with the previous 3GPP technologies

First 3GPP release considering LTE was released in 2008 as 3GPP Release number 8. The first release supported data rates up to 300 Mbps in downlink and 75 Mbps in uplink, which provides significant improvement in data rates when compared to earlier technologies. In addition, Release 8 introduced interworking with technologies like GSM and WCDMA. Table 1 summarizes main differences and key features between LTE and preceding technology UMTS.

Table 1: LTE and UMTS key feature comparison [2]

<b>Feature</b>	<b>LTE</b>	<b>UMTS</b>
Access technology	OFDMA and SC-FDMA	WCDMA
Bandwidth	1.4, 3, 5, 10, 15 or 20 MHz	5 MHz
Downlink Modulation	QPSK, 16QAM, 64QAM	QPSK 16QAM since release 5 64QAM since release 7
Uplink Modulation	QPSK, 16QAM, 64QAM	QPSK 16QAM since release 7
MIMO support	Yes	Since Release 7
Frame duration	10 ms	10 ms
Modes of operation	FDD and TDD	FDD and TDD
Transport channels	Shared	Dedicated and Shared
Handovers	Hard	Soft and Hard
IP version support	IPv4 and IPv6	IPv4 and IPv6
Transport mechanism	Packet switched	Packet and circuit switched
Voice and SMS services	External	Included

Since Release 8, LTE has seen several improvements during early 2010s. New releases have introduced improved data rates in forms of features like Carrier Aggregation (CA), as well as interworking between FDD and TDD. Currently 3GPP

is working on 13th release introducing more features on LTE, while simultaneously preparing for incoming Fifth Generation of technologies. Other standardization organizations like GSM Association (GSMA) have also taken active role in LTE development by introducing LTE with additional features like Voice-over-LTE (VoLTE), which brought voice services available on packet-switched LTE network. [3]

Figure 1 shows release times of LTE releases by 3GPP, as well as key improvements introduced with each release.

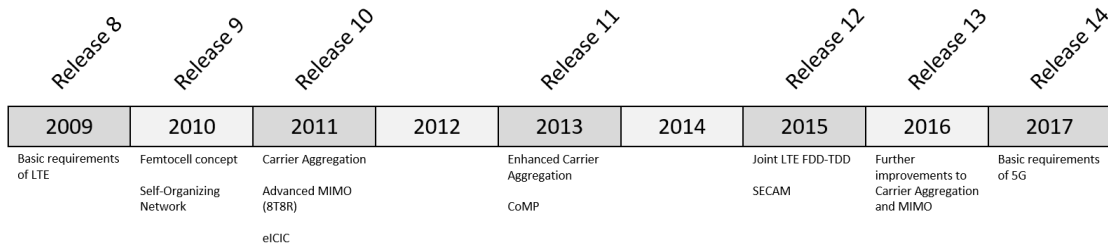

Figure 1: LTE release timeline

## 2.2 Basic network structure of EPS

Since this thesis aims to study different functionalities of LTE, it is important to understand what are the different elements and their functions within LTE network. While LTE as a term refers to a wireless communication technology, it is used in this thesis more widely to cover the whole network under discussion. Fourth Generation network discussed in this thesis is more generally known as Evolved Packet System (EPS). EPS can be divided to two different parts: core network known as Evolved Packet Core (EPC), and radio access network known as Evolved Universal Terrestrial Radio Access Network (E-UTRAN). This thesis will focus mainly on the radio access network, but it is also important to understand what different functionalities are placed within the core network. The system structure of EPS can be seen in figure 2. Following section will also introduce all key network elements.

### User Equipment (UE)

UE represents the user device within LTE network. In practice, UEs are often handheld mobile devices or separate router devices. UE runs an application called Universal Subscriber Identity Module (USIM), which stores information that is used to recognize users from each other. Information stored on the USIM is used for authentication when UE is registering to network in order to use provided services. Mobile operators are able to control subscriptions based on USIM cards, and for example service quality differentiation is sometimes based on granting certain USIM cards differentiated service. UE is connected to a base station through radio interface called LTE-Uu. LTE-Uu consists of multiple protocols, which are further described in section 2.3. [2]

In the studied network, UE devices do not include mobile phones since 450 MHz radio access technology requires relatively large antennas in order to effectively

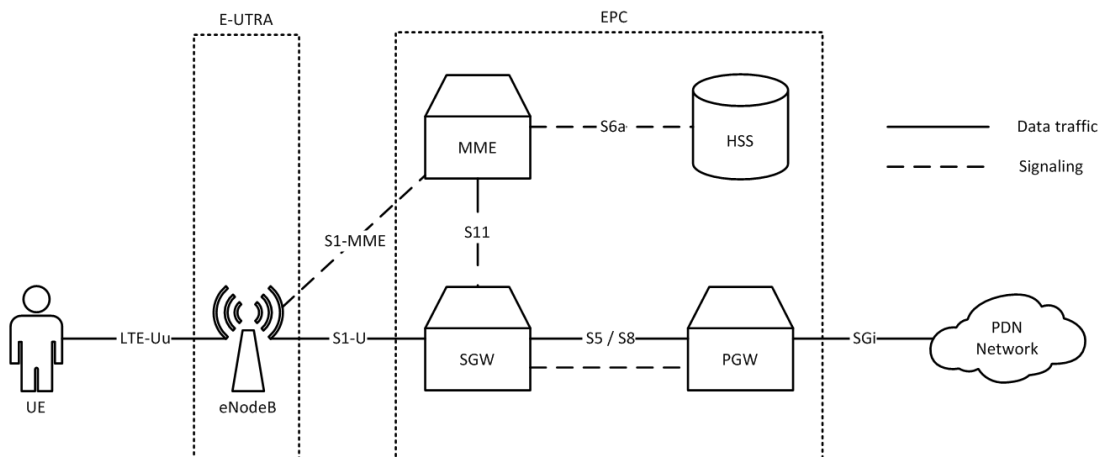

Figure 2: EPS network structure

transmit and receive radio signals. This limitation is caused by longer amplitude of relatively low frequency. UEs used in LTE are categorized based on their capabilities. Different categories are separated based on variety of radio capabilities including maximum data rates and supported modulation. These capabilities are reported to network during attach procedure in order to provide network with information considering the proper handling of each UE. These different categories and their related capabilities are listed in table 2.

Table 2: 3GPP defined UE categories [4]

UE Category	Introduced in	DL/UL rate	Modulation	Rx/Tx
Category 1	Release 8	10 / 5 Mbps	64QAM / 16QAM	1 / 1
Category 2	Release 8	50 / 25 Mbps	64QAM / 16QAM	2 / 1
Category 3	Release 8	100 / 50 Mbps	64QAM / 16QAM	2 / 1
Category 4	Release 8	150 / 50 Mbps	64QAM / 16QAM	2 / 1
Category 5	Release 8	300 / 75 Mbps	64QAM / 64QAM	4 / 1
Category 6	Release 10	300 / 50 Mbps	64QAM / 16QAM	4 / 1
Category 7	Release 10	300 / 100 Mbps	64QAM / 16QAM	4 / 2
Category 8	Release 10	3000 / 1500 Mbps	64QAM / 64QAM	8 / 4

### eNodeB

E-UTRAN consists only of one network element, which is called evolved Node B (eNodeB). In previous technologies like UMTS, radio access network consisted of two main components: a base station communicating with mobile device, and a separate Radio Network Controller (RNC) communicating with the core network. However, in LTE these components have been combined as one, making LTE so called flat architecture with lower costs and reduced latency. eNodeB is responsible



for both radio transmission and reception to and from UE, as well as communicating with EPC. It acts as an access point for users who are using the network within its coverage area. Single eNodeB may consist of one or multiple cells each having their own configuration based on desired network parameters. Each eNodeB is connected to core network through S1 interface, which can be divided on two logical interfaces called S1-MME and S1-U. Signaling traffic, including handover and Non-Access Stratum (NAS) messaging, is carried through S1-MME interface, while data traffic produced by UEs is carried through S1-U interface. There exists also optional X2 interface, which is used to connect eNodeBs with directly with each other. X2 interfaces are involved for example in handover communications. If X2 interfaces are not deployed, all communication between eNodeBs is handled through S1 interface. [2][5]

### **Mobility Management Entity (MME)**

MME is responsible for NAS signaling between UE and core network. NAS messages are often divided to two main categories: user session management signaling and user mobility management signaling. User session management signaling includes setting up, modifying and releasing default and dedicated bearers, and is therefore more commonly known as a bearer management functionality. User mobility management signaling includes all handover related signaling between eNodeBs and UEs. MME also keeps track of subscribers with the help of tracking areas and pages UEs who might have dropped to idle state. Mobility management is further discussed in chapter 3. Additionally, MME is also responsible for allowing lawful interception of signaling traffic and taking care of mobility management between different access networks. In addition to mentioned S1-MME interface between MME and eNodeB, MME is connected to HSS via S6a interface for user authentication purposes, and to SGW via S11 interface. [5][6]

### **Serving Gateway (SGW)**

SGW is the traffic gateway used by eNodeBs. Each eNodeB is connected to at least one SGW, which is then used as an anchor point for user data traffic. In addition to S1-U and S11 interfaces, SGW is connected to PGW through S5 interface. S5 interface is used for user plane tunneling and tunnel management between SGW and PGW. LTE is also capable of mobile roaming, where local SGW is connected to the users home PGW. In such scenario, S5 interface is called S8 instead, since it has a slightly different working method when compared to S5. [5][6]

### **Home Subscriber Server (HSS)**

HSS is a core element which is used to store subscriber information. During initial connection establishment, MME verifies from HSS that user accessing the network is a valid user and allowed to connect to the network. HSS does not handle data traffic sent by users, since it is only communicating with signaling messages sent to MME via S6a interface.

### Packet Gateway (PGW)

PGW, also known as Packet Data Network-Gateway (PDN-GW), is a core element providing packet access in and out the mobile network. PGW is in charge of creating a PDN session with UEs, as well as keeping track of data usage of the subscribers. It may forward usage data to a separate entity called Online Charging System (OCS), which is a network element used especially when offering prepaid subscriptions. PGW acts as a terminating point for tunneled connections originating from UEs, while simultaneously acting as a routing entity forwarding traffic in and out from EPC towards desired network. This network can be for example intra-operator network serving some special service for a certain group of subscribers. However, in most cases this packet-based network is external public or private network where user traffic is forwarded. Public network is often associated with Internet, while private connections can be related with special solutions where certain customers are trying to reach their own private network through mobile operators radio access network. Communication with external or internal networks happens through SGi interface. PGW may also communicate with Policy and Charging Rules Function (PCRF) through a separate S7 interface. PCRF is an element that aids PGW with Quality of Service (QoS) control and enforcing rules and policies within network. [5][6]

## 2.3 Signaling protocols

Significant change from previous circuit switched technologies was made when LTE was standardized as packet-only based network. Previous technologies have widely utilized Signaling System Number 7 (SS7) as their main signaling protocol, which has been replaced with Internet Protocol (IP) based transmission primarily used in modern applications of Internet. Following section introduces signaling protocols associated with LTE network. Top-level protocols include NAS signaling required for connection setup and application traffic used in actual communication. In addition to presented protocols, other signaling protocols do exist within and between different network elements of EPC. However all of the protocols are not discussed within the scope of this thesis. Most of other interfaces and protocols are IP based, and utilize mostly protocols like the User Datagram Protocol (UDP) and Diameter. LTE Protocol stacks are defined in 3GPP specification 23.401. [7]

NAS signaling connection between UE and MME is initiated in various occasions including attach, detach and mobility management. As mentioned in previous section, NAS signaling consist of two interfaces, namely LTE-Uu and S1-MME, which are located between UE and eNodeB and between eNodeB and MME, respectively. These interfaces are defined with certain protocol stacks. The stack between eNodeB and MME is similar to Open Systems Interconnection (OSI) protocol stack because of packet-based traffic used in EPS. Since characteristics of radio connection differ from the ones seen within the fixed line communications, radio connection between UE and eNodeB uses a number of additional protocols. Figure 3 introduces the protocol stack of NAS signaling, followed by short description of used protocols. [6]

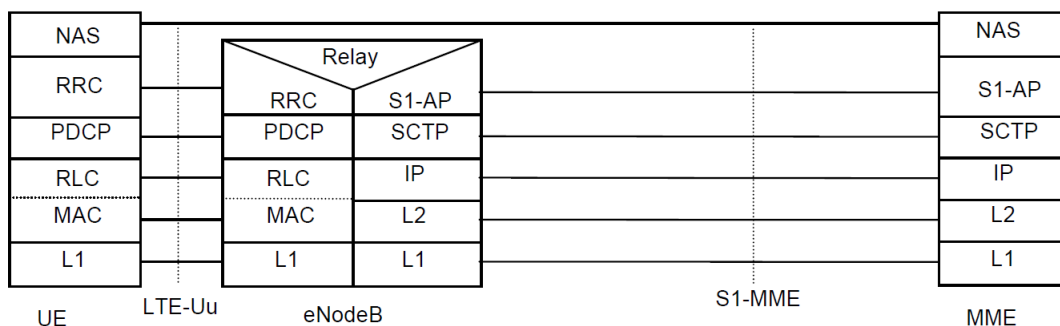

Figure 3: NAS signaling protocols [7]

- **L1** (Layer 1) protocol refers the lowest layer of transmission. For example in radio connections, L1 refers to modulation, scrambling and error correction functions needed to minimize errors over the connection. In fixed line communications L1 is often referred as physical layer.
  - **MAC** (Medium Access Control) protocol handles the scheduling of downlink and uplink traffic and determines which transport channels traffic is using. Transport channels are further discussed in section 2.4.
  - **RLC** (Radio Link Control) protocol optimizes the use of available resources on radio link. It also handles retransmission and duplicate detection that may occur on the link.
  - **PDCP** (Packet Data Convergence Protocol) is in charge of ciphering and integrity protection of the control plane data.
  - **RRC** (Radio Resource Control) protocol is considered as the signaling connection over LTE-Uu interface. It handles mobility management, radio bearer control, QoS control and measurement control over radio interface. Different RRC protocol states are further discussed in chapter 3.
  - **NAS** (Non Access Stratum) protocol covers mobility management and user-plane bearer management in addition with ciphering and protection of the NAS signaling.
- 
- **L2** (Layer 2), also referred as Data Link Layer, is a layer which forwards data segments within same Local Area Network (LAN). In general, Layer 2 is often known as Ethernet connection.
  - **IP** (Internet Protocol) acts as network layer protocol forwarding traffic between different entities.
  - **SCTP** (Stream Control Transmission Protocol) works on top of the IP layer, and functions in many ways similar to Transmission Control Protocol (TCP). It provides IP connection with reliability during signaling message transmission. Both IP versions 4 and 6 are supported.
  - **S1-AP** (S1 Application Protocol) multiplexes individual connections to the SCTP. [3][6]

When sending application data over LTE network, an IP based tunneling session is formed between eNodeB and PGW. LTE-Uu interface has similar protocol stack when compared to NAS signaling, but without the RRC layer. S1-U and S5/S8 interfaces enable the tunneling of application data on top of IP based network. Figure 4 illustrates protocols associated in signaling between UE and PGW.

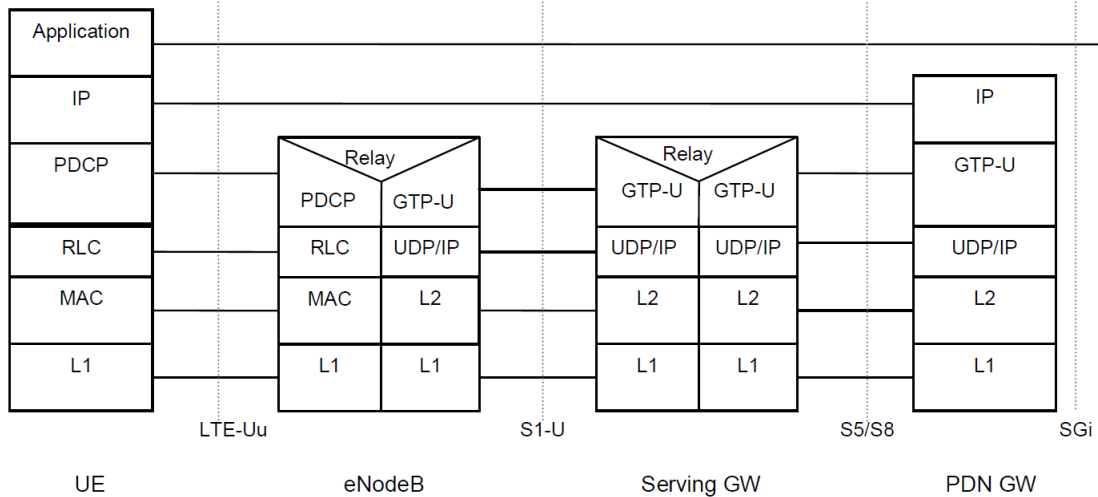

Figure 4: Application signaling protocols [7]

- **UDP** (User Datagram Protocol) is a connectionless transmission protocol working alongside with IP. In other services, UDP is widely used in real-time applications such as gaming due to its ability to reduce delays.
- **GTP-U** (GPRS Tunneling Protocol) is used over UDP for channeling the user data over S1 interface. It facilitates the tunnel connection over EPC and supports mobility between various radio access technologies. [6][7]

## 2.4 Evolved Universal Terrestrial Radio Access Network

In this section, basics of LTE radio access technology are introduced covering selected access schemes and modulations. As discussed in the first section of this chapter, LTE has been developed based on the preceding UMTS network. In UMTS, radio access is based on WCDMA technology, which has been replaced with Orthogonal Frequency-Division Multiple Access (OFDMA) and Single-Carrier Frequency-Division Multiple Access (SC-FDMA) in LTE. OFDMA has been selected as the access technology in downlink direction, while SC-FDMA is used in uplink direction.

### 2.4.1 Duplex schemes

In order to successfully execute cellular communications, data has to be transmitted in both uplink and downlink simultaneously. Method of sending two-way communications over a communication channel is called duplexing, which can be categorized

in two standard schemes: half duplex and full duplex. Half duplex scheme allows transmitting data in two directions, but only in one direction at a time. When one transmitter is transmitting, other must wait until the first one stops. This duplex method is commonly used in for example handheld two-way radios. In full duplex scheme both parties may transmit simultaneously, even though that some level of separation has to be done in a way that transmissions do not interfere with each other. LTE has been specified with two different full duplex methods, Frequency Division Duplex (FDD) and Time Division Duplex (TDD). In FDD, downlink and uplink transmissions are separated by using different frequency bands, where one band is used for uplink and other band for downlink. In TDD, both uplink and downlink transmissions are occurring on the same frequency band, but are separated in time domain. In this case, a certain Guard Period (GP) is needed in order to prevent interference between uplink and downlink transmissions. Basic principles of FDD and TDD duplex methods are introduced in figure 5. [8][9]

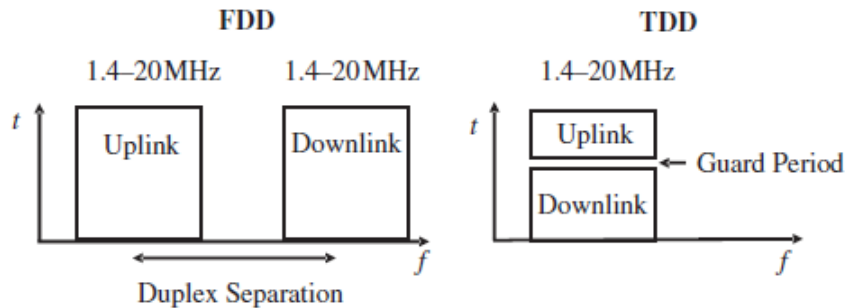

Figure 5: LTE duplex schemes [3]

Preceding technologies like UMTS have widely utilized FDD based technologies like WCDMA, which is one of the main reasons why LTE is primarily specified through FDD based requirements related to both technology and spectrum allocation. However, nowadays both duplex modes are widely supported. Duplex methods specified for LTE differ mostly in the physical layer of transmission. Most terminals support both duplex methods, which gives mobile operators great benefits in terms of network planning and harnessing advantages of both duplex modes. Table 3 lists main differences between FDD and TDD duplex methods. When compared with FDD, TDD has certain unique features. These features are for example different frame structure, scheduling in uplink and the presence of GP. Following sections covering the basics of LTE are discussed in FDD perspective. Separate mentions considering TDD are made when applicable. [9]

#### 2.4.2 Orthogonal Frequency-Division Multiple Access

OFDMA was selected as the downlink access technology because it offers several advantages that support requirements set for LTE. OFDMA offers for example good spectral properties and is scalable for multiple different bandwidths. On receiver

Table 3: Comparison between FDD and TDD [10]

<b>Parameter</b>	<b>FDD</b>	<b>TDD</b>
Spectrum requirements	Requires paired spectrum	Only one channel required
Traffic asymmetry	Depends on available spectrum	Dynamically adjustable
Duplex separation	Guard band in frequency domain required	Guard Period in time domain required
Intra-system Interference	Unlikely to occur	Time synchronization between eNodeBs is required
Cell size	Suit for small and large cells	Suits for smaller distances because of Guard Period
Hardware costs	Higher costs caused by complicate diplexer	No major cost affects

side, OFDMA reduces receiver complexity and supports various advanced receiver and antenna technologies. However, OFDMA also has some downsides: transmitted signal in OFDMA has relatively high Peak-to-Average Ratio (PAR), which is caused by high peaks within the output signal. This increases power consumption of transmitting devices, and is therefore one of the main reasons why OFDMA is not optimal solution for uplink direction. In addition to LTE, OFDMA has been widely adopted in many areas including digital television and Wireless Local Area Networks (WLAN) because of its affordability and feasibility. [3]

OFDMA as a technology is based on the concept of Orthogonal Frequency Division Multiplexing (OFDM), where different carriers are separated orthogonally within frequency domain. This allows sending multiple sub-carriers within the same frequency domain in a way that carriers overlap slightly, thus providing better spectrum efficiency. Usually there has to be a certain guard band between different carriers in order to eliminate interference. In LTE, OFDMA is using constant frequency of 15 kHz between different sub-carriers, which creates a situation where other neighboring sub-carriers have zero values during the sampling point of the desired sub-carrier. This is illustrated in figure 6.

OFDMA used in LTE also differs from OFDM by offering a multiple access scheme, where multiple users are allocated on different sub-carriers simultaneously instead of giving the whole bandwidth to a single user. Individual users must be allocated minimum of 12 adjacent sub-carriers, which forms 180 kHz wide continuous band. These 180 kHz wide parts of the spectrum are called Physical Resource Blocks (PRB), and will be discussed later in this chapter. Total amount of available sub-carriers is limited by the available bandwidth. Initial specifications introduced LTE with several bandwidth options ranging from 1.4 MHz to 20 MHz. With carrier aggregation, multiple bands can be combined in order to achieve even higher throughputs.

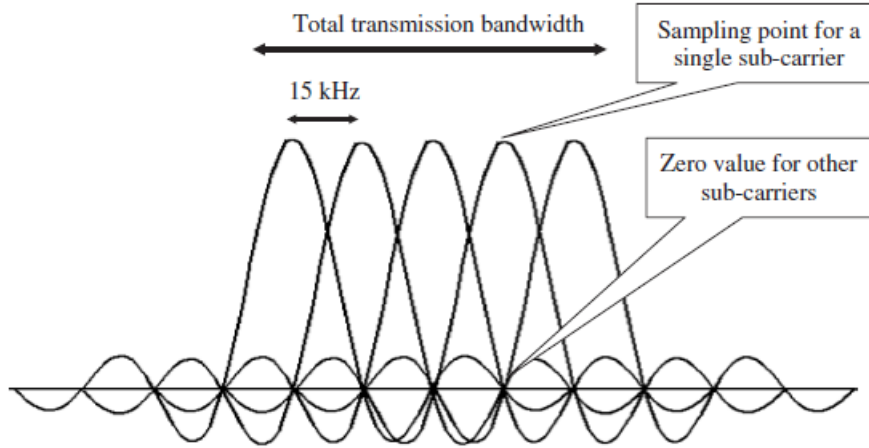

Figure 6: OFDMA sub-carrier spacing [3]

Even though that utilization of orthogonal sub-carriers is reducing the need for guard bands in frequency domain, some collision might still occur within time domain. When travelling long distances, symbols sent consecutively at the same frequency may collide at receiving end. This phenomenon is called Inter-Symbol Interference (ISI). In order to prevent ISI, specific Cyclic Prefixes (CP) are attached in front of each OFDMA symbol, thus creating a guard interval between sent symbols within time domain. Basic principle of CP is to copy a part of symbol from the end and add it to the beginning of the symbol. Cyclic extension function is illustrated in the figure 7.

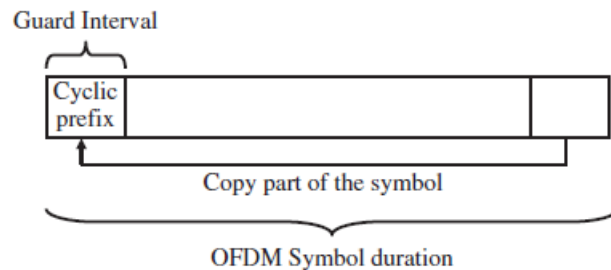

Figure 7: Cyclic extension principle [3]

CP has two predetermined values, which are called normal and extended CP. Normal CP length is  $5.21 \mu\text{s}$ , while extended duration is  $16.67 \mu\text{s}$ . Either of these values can be used depending on the desired cell range. Since the function of cyclic extension is to minimize interference caused by overlapping symbols at the receiving end, a longer CP is needed when covering significantly longer distances. Usually normal CP is used for cell ranges below 50 km, and extended CP with cell ranges from 50 to 90 km. Extended CP has also a downside, since adding a longer guard interval before each symbol reduces the total amount of symbols that can be sent within a time slot. When cyclic extension is changed from normal to extended, the amount

of sent symbols within 0.5 ms slot is reduced from seven to six. This means that data throughput is reduced at same rate. Therefore extended CP should be used only if necessary. [3]

When covering distance through air interface, radio signals are affected by propagation and scattering caused by various physical phenomena. In order to improve channel estimation capabilities of the receiver, OFDMA signal is equipped with reference symbols. Reference symbols replace individual data symbols in specific and pre-determined slots as illustrated in figure 8. Receiver can then evaluate the received channel in order to improve its receiving capabilities.

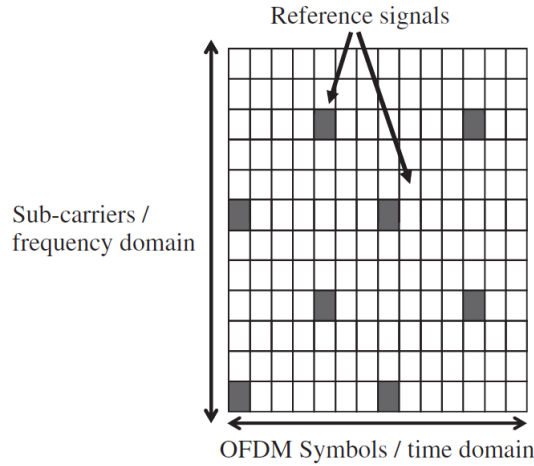

Figure 8: Reference signal mapping principle [3]

### 2.4.3 Single Carrier Frequency-Division Multiple Access

High power consumption associated with OFDMA is often not desired when considering the power usage of small mobile devices used in mobile networks. This is one of the main reasons why Single Carrier Frequency-Division Multiple Access (SC-FDMA) was chosen as the access technology for uplink direction. SC-FDMA is in many ways similar to OFDMA, since it also utilizes available bandwidth efficiently and uses cyclic extension to counter interference. In SC-FDMA different symbols are not transmitted simultaneously, but one at a time. Similar approach is used in other Time Division Multiple Access (TDMA) systems, such as GSM. As shown in figure 9, SC-FDMA symbol occupies the whole bandwidth intended for specific user. When available bandwidth grows, individual symbol occupies a wider space in frequency domain, thus shortening the symbol duration in time domain.

Similarly to OFDMA, SC-FDMA also has a minimum resource allocation of one PRB occupying 180 kHz in frequency domain. While in OFDMA reference symbols are distributed periodically among different sub-carriers, SC-FDMA replaces symbols from the middle of the allocated time slot as shown in figure 9. In addition to reference signaling, CP in SC-FDMA has a different structure when compared to OFDMA. In SC-FDMA, cyclic prefixes are not inserted in front of each symbol, but



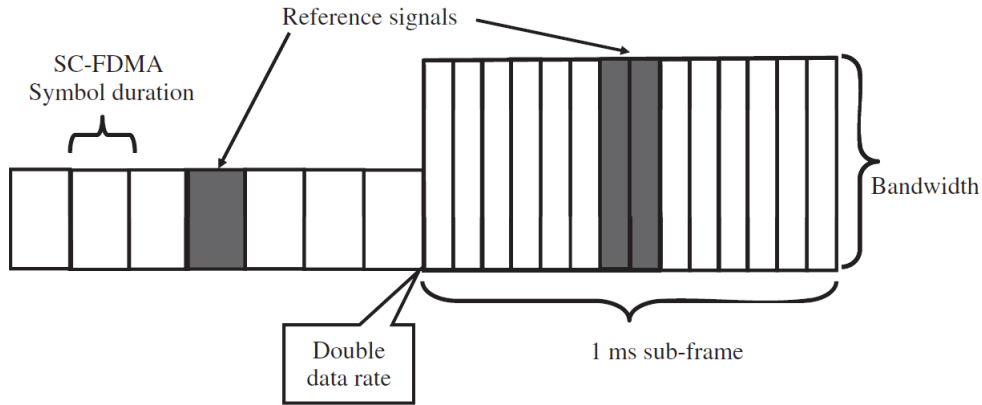

Figure 9: SC-FDMA principle [3]

in between a block of symbols. This is more convenient, since the sent symbol is alternating much more rapidly than in OFDMA, where the same symbol would be sent during a longer period of time. This causes a situation where receiver, which in LTE is a base station, for one has to deal with inter-symbol interference. This increases the processing power required by the receiver, but this is not seen as a major issue since base stations usually do not have to worry about the preservation of power on same scale as mobile devices. This is an acceptable downside, since SC-FDMA offers better performance on uplink range and transmitter power efficiency.

#### 2.4.4 Multiple Input Multiple Output

Traditional transmission from one transmitting antenna to one receiving antenna is often referred as Single Input Single Output (SISO) transmission. However, nowadays most wireless technologies are using multiple antennas in order to take advantage of diversity gain, which improves quality of received signal. Release 8 of LTE supported multi-antenna technology in most UE categories, and following releases have introduced even further improvements. Even most simple base station deployments are taking advantage of two receiving antennas, which is often referred as Single Input Multiple Output (SIMO).

However, single transmission streams are facing physical limitations reducing achievable data rates. By introducing LTE with Multiple Input Multiple Output (MIMO) feature, even higher data rates can be achieved. The basic principle of MIMO is to transmit data from multiple antennas, hence theoretically increasing maximum data rate in same rate as the number of antennas increases. For example, when two antennas are used for transmission and reception, data rate is theoretically doubled. Even though that data is transmitted from different antennas, same frequency and time resources are used. In release 10 LTE was specified with several MIMO classes, using two, four or eight antennas. In notation commonly used with MIMO, T stands for transmission and R for receiver. Figure 10 represents the principle with 2T2R MIMO system.

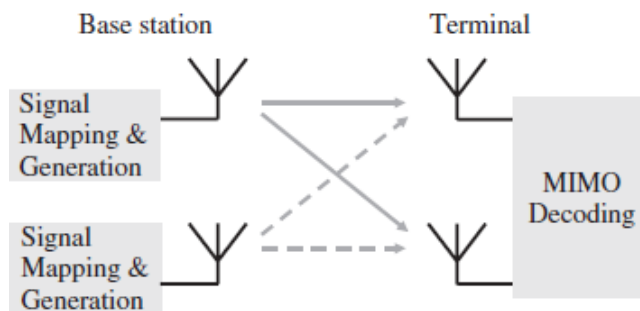

Figure 10: MIMO principle [3]

MIMO feature is based on spatial multiplexing, transmit diversity and precoding. In short, spatial multiplexing means sending two different data streams from separate transmission antennas. These different streams are then combined at the receiving end. Receiver uses reference signals to differentiate multiple transmissions from each other. When using MIMO, reference symbols are mapped in a way that same symbol slots are not used for reference signals between two simultaneously transmitting antennas. This way reference signals do not interfere each other and are more easily distinguishable. Reference signal mapping is further illustrated in figure 11.

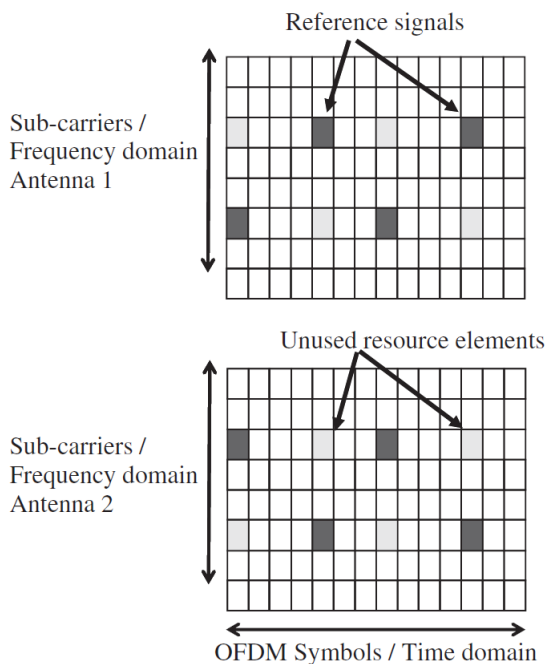

Figure 11: MIMO reference signals [3]

In order for MIMO to function properly, relatively high Signal-to-Interference-and-Noise-Ratio (SINR) is required. At the event of low SINR, receiver is not able to decode the transmission properly. In such cases, multiple transmitting antennas

may be used to transmit the same data stream, which improves received quality of the signal. However, this does not improve data rates, since only one data stream is sent over the air.

### 2.4.5 Physical layer transmission

#### Modulation

Previous sections have introduced some of the major characteristics of LTE radio access technology. In both OFDMA and SC-FDMA sections, symbols were introduced as a standard unit of transported data. Information in modern digital communication networks is carried with bits, ones and zeros. In order to create understandable strings of data, receiver has to receive correct bits in same order that sender has intended. Air interface poses multiple threats for data transmission through means of propagation and lost information. One should also consider that transmitting individual bits over the air forms bottlenecks within throughput. In order to tackle these issues, symbols and modulation are used to transmit data. This increases achieved rate of bits transmitted over a time slot.

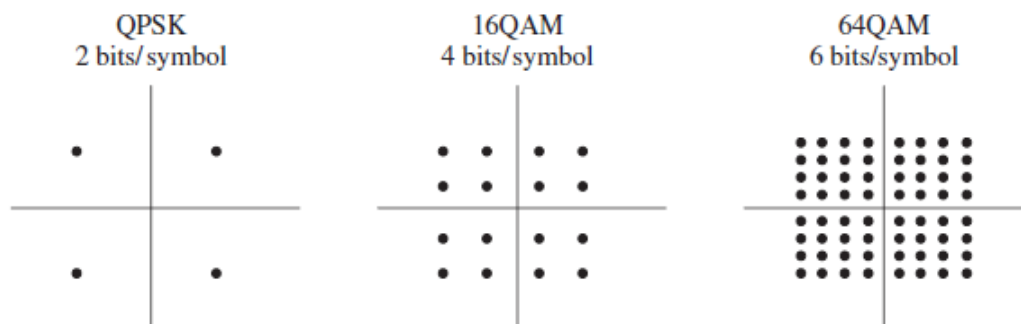

Figure 12: LTE modulation constellation diagrams [3]

LTE is specified with three modulation schemes: Quadrature Phase Shift Keying (QPSK), 16-Quadrature Amplitude Modulation (QAM) and 64-QAM. Constellation diagrams are illustrated in figure 12. Main purpose of modulation is to send larger number of bits by shifting amplitudes of associated sinusoidal carrier waves. Modulation used depends on the available channel quality: higher order modulation provides better data rates, but is less resilient to noise and interference. Used modulation is therefore chosen dynamically according to available radio conditions and modulations supported by communicating parties. Some control channels utilize Binary Phase Shift Keying (BPSK), which is able to transmit only one bit per symbol. [11]

#### Physical channels

LTE communication channels consist of three types of channels: logical, transport and physical channels. Logical channels divide traffic according to the type of traffic, while transport channels map data based on the type of transmission. Finally,

physical channels define in which symbols data is transmitted. Physical channels can be further divided to data channels and control channels. LTE relies on shared channel architecture, which means that multiple logical and transport channels can be mapped on a single physical channel.

#### **Physical Downlink Shared Channel (PDSCH)**

PDSCH is responsible for carrying all downlink data heading to UE. It transmits both user plane data and user specific RRC messages. Since PDSCH transmits user plane data, it occupies most of the available downlink resources.

#### **Physical Broadcast Channel (PBCH)**

PBCH carries the Master Information Block (MIB), which is transmitted steadily in 40 ms intervals. Main purpose of MIB is to inform UEs about system bandwidth.

#### **Physical Multicast Channel (PMCH)**

PMCH is not used in current applications of LTE, although it has been defined in order to support future LTE releases.

#### **Physical Control Format Indicator Channel (PCFICH)**

PCFICH is transmitted in the first OFDM symbol of each subframe. Its main purpose is to indicate how many symbols are used for PDCCH within the following subframe.

#### **Physical Downlink Control Channel (PDCCH)**

PDCCH transmits Downlink Control Information (DCI), which is used to provide information about scheduling in downlink and scheduling grants for uplink.

#### **Physical HARQ Indicator Channel (PHICH)**

PHICH carries Hybrid Automatic Repeat Request (HARQ) feedback information to UEs. Purpose of HARQ messages is to verify whether eNodeB has received previous uplink transmission from associated UE.

#### **Physical Uplink Shared Channel (PUSCH)**

PUSCH is used to transmit uplink data in similar way that PDSCH transmits downlink data. However, resources for uplink transmission are assigned to UEs by PDCCH.

#### **Physical Uplink Control Channel (PUCCH)**

PUCCH transmits physical layer control information. It includes for example HARQ feedback from the UE, uplink resource requests and downlink reception quality feedback information.

#### **Physical Random Access Channel (PRACH)**

PRACH is used for random access during UEs initial attach to network.

In addition to presented physical channels, downlink is associated with two synchronization signals called Primary Synchronization Signal (PSS) and Secondary Synchronization Signal (SSS). PSS is mostly used during cell search and time slot synchronization. SSS is used to carry information considering for example used duplex method and cyclic extension length. Downlink physical layer transmits also reference signals, which exist only on physical layer and are not carrying any user data. Reference signal measurement is further discussed in chapter three. [5]

### Frame structure

In order to allocate resources in time and frequency domain, LTE uses predefined frame structure to divide available resources. The smallest specified unit in time domain is called sampling interval  $T_s$ , which is derived from fast Fourier transform containing 2048 points. One symbol lasts  $2048 T_s$ , which is equal to  $66.7 \mu\text{s}$ . Depending on the length of CP, six or seven symbols are grouped in one slot lasting  $0.5 \text{ ms}$ . Two slots form one subframe and finally 10 subframes form one frame with length of  $10 \text{ ms}$ . This is illustrated in figure 13.

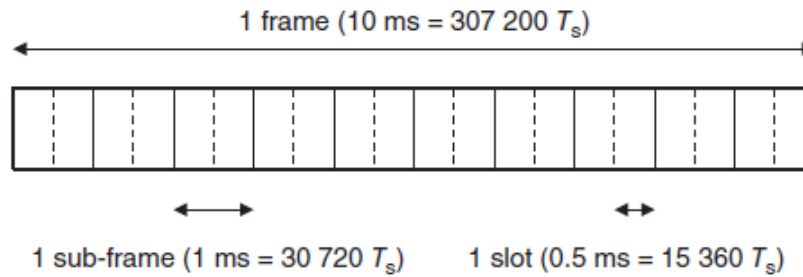

Figure 13: LTE basic frame structure [2]

Resource scheduling is done based on subframes. When eNodeB transmits data to downlink, transmission is scheduled one subframe at a time. Data is then mapped to sub-carriers within that specific subframe. Depending on duplex method, two different frame structures are used. These structures are called frame structure type 1, which is used in FDD, and frame structure type 2 used in TDD. Structures are mostly similar but some differences do exist. Type 1 frame is mapped with uplink or downlink data depending on the associated band. In type 2 each subframe can be mapped with either downlink or uplink data. In type 2 frame, subframes can also be mapped as special subframes, which are used during transitions from downlink to uplink transmission. Special subframe consist of three different regions called special downlink region, special uplink region and guard period, and they are noted as DwPTS, UpPTS and GP, respectively. Special downlink region is used for normal downlink transmission, while special uplink region is used for example PRACH transmission. Guard period serves important purpose of adjusting timing advance between downlink and uplink transmissions. Larger cell size requires greater timing advance in order to avoid collision between uplink and downlink traffic. Mapping of subframes in type 2 frame can be adjusted in order to obtain uplink/downlink

relation. Depending on the chosen ratio, either one or two special subframes exist within one frame. Subframe mapping is also referred as subframe configuration, which has been specified within 3GPP specification 36.211. Table 4 represents the relation between uplink and downlink subframes within different configurations. [12]

Table 4: TDD subframe configurations [12]

Configuration	Switching periodicity	Subframe type									
		D	S	U	U	U	D	S	U	U	U
SA0	5 ms	D	S	U	U	U	D	S	U	U	U
SA1	5 ms	D	S	U	U	D	D	S	U	U	D
SA2	5 ms	D	S	U	D	D	D	S	U	D	D
SA3	10 ms	D	S	U	U	U	D	D	D	D	D
SA4	10 ms	D	S	U	U	D	D	D	D	D	D
SA5	10 ms	D	S	U	D	D	D	D	D	D	D
SA6	5 ms	D	S	U	U	U	D	S	U	U	D

While subframe is used as a smallest unit of scheduling, PRB is used as a smallest unit of resource allocation among network users. As described, individual bits are transferred over the air by utilizing available modulation scheme QPSK, 16QAM or 64QAM. The most basic unit of transmission is called Resource Element (RE), which contains one symbol carrying two, four or six bits depending on the modulation. One RE is sent within the duration of one symbol. One PRB may include 6 or 7 symbols in time domain depending on symbol prefix length, and therefore 72 or 84 REs are grouped as one PRB spanning over one slot in time domain and 180 kHz in frequency domain. The basic structure of one PRB is shown in figure 14.

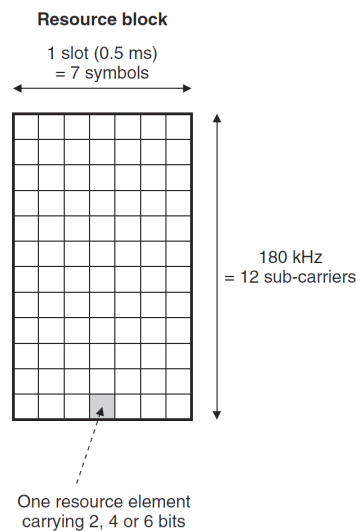

Figure 14: Physical Resource Block structure [2]

Number of PRBs available for transmit depends on the available total bandwidth. Since one PRB occupies 180 kHz in frequency domain, smallest specified bandwidth of 1.4 MHz can utilize 6 resource blocks simultaneously consisting of  $6 \times 12 = 72$  sub-carriers in total. Even though that 1.4 MHz could theoretically fit more than 6 PRBs, there is a pre-determined guard band which has to be allocated on both sides of transmission in frequency domain. Table 5 summarizes the amount of PRBs with used bandwidths. This reduces the interference from adjacent transmission. In time domain, one PRB occupies one slot, which means that one subframe has the length of two PRBs and one frame includes 20 PRBs in time domain. [2]

Table 5: Number of PRBs in specified bandwidths [2]

<b>Specified bandwidth</b>	<b>Number of PRBs</b>	<b>Number of sub-carriers</b>
1.4 MHz	6	72
3 MHz	15	180
5 MHz	25	300
10 MHz	50	600
15 MHz	75	900
20 MHz	100	1200

## 3 EPS Mobility Management

Previous chapter introduced basics of Fourth Generation LTE network. This chapter covers topics related to mobility management in EPS. Important performance indicators are covered in the first section of this chapter. Second section describes principles of UE state management, while the third section introduces concept of mobility management.

### 3.1 LTE performance indicators

In order to effectively measure quality of the physical layer, 3GPP has defined measurement quantities for UEs. These values are measured by UE and reported back to eNodeB. eNodeB uses these values to decide whether the current serving cell provides sufficient service, or whether there is need for handover to another cell. In this section, three different 3GPP specified measurement values are presented. These values have a key role when mobility and channel quality related decisions are made. All of the values are defined in 3GPP 36.214 [13].

#### 3.1.1 Reference Signal Receiver Power (RSRP)

Reference Signal Received Power (RSRP) is defined in [13] as “the linear average over the power contributions of the resource elements carrying cell-specific reference signals within the considered measurement frequency bandwidth”. To better understand the description, measured signal has to be examined on RE level: in each PRB, specific REs are reserved for carrying Reference Signal (RS). The basic concept of RS was covered in chapter two. When measuring RSRP, UE measures the average power of all REs carrying RS over the entire available bandwidth. According to specification, UE should use the antenna connector as a reference point for the measurements. RSRP values are mapped from -44 dBm to -140 dBm, where greater RSRP value indicates stronger received signal. Rule of thumb is that RSRP values exceeding -75 dBm indicates very good signal strength, while values under -100 dBm are affecting the quality of received service. RSRP values are mapped to a report range consisting of 98 reportable values. This means that the UE is able to report RSRP measurements with accuracy of one dBm. UE conducts RSRP measurements in both, connected and idle mode. In practice RSRP measures the strength of the transmission signal UE is receiving from the eNodeB. However, RSRP does not give any indication on quality of the signal. Therefore, additional information from the signal is required. [5][14]

#### 3.1.2 Receiver Signal Strength Indicator (RSSI)

Reference Signal Strength Indicator (RSSI) indicates the total received power of the used channel. Definition for RSSI states that it “comprises the linear average of the total received power observed only in the configured OFDM symbols and in the measurement bandwidth over N number of resource blocks” [13]. RSSI measures the



total received power over the bandwidth and from all sources, which includes also thermal noise and interference from adjacent channels or other nearby cells. [5]

### 3.1.3 Reference Signal Received Quality (RSRQ)

3GPP specification [13] defines Reference Signal Received Quality (RSRQ) as the ratio between PRBs, RSRP and RSSI. RSRQ is not directly measured from the signal, while it is calculated from the measured values of RSRP and RSSI. The formula for calculating RSRQ is:

$$RSRQ = N * (RSRP/RSSI) \quad (1)$$

where N is the number of PRBs used by the measured cell. As mentioned, RSRP is measured from REs carrying the reference signal, while the RSSI is measured over the entire bandwidth. The standard reporting range for RSRQ is between -19.5 dB and -3.0 dB with resolution of 0.5 dB. Similarly to RSRP, RSRQ can be defined with quality ranges informing observer about the expected quality of service. RSRQ values over -9.0 dB indicate that the signal quality is fairly good, while values between -9.0 dB and -12.0 dB are considered neutral. When RSRQ goes under -13.0 dB, significant declines in received service can be seen.

RSRQ is an important factor when defining signal quality levels and troubleshooting problems within network. In many situations RSRP of the received signal may have excellent values indicating that user is able to receive strong signal. However, RSRQ is able to indicate whether the received signal is influenced by interference or excess noise from other sources. RSRQ values are measured in connected state. [5]

### 3.1.4 Signal-to-Interference-and-Noise-Ratio (SINR)

Many device manufacturers have replaced RSRQ with Signal-to-Interference-and-Noise-Ratio (SINR) when displaying the quality of signal. SINR is calculated with the following formula:

$$SINR = S/(I + N) \quad (2)$$

where S indicates the power of measured signal, I the average interference power and N the received background noise. All values are measured over the same bandwidth and then normalized to cover only one PRB. SINR can provide UEs with more accurate results to aid the UE in decision-making process. UE does not report SINR to network, since it lacks the required specification by 3GPP. Instead it may be used to calculate specific Channel Quality Indicator (CQI) values, which are then reported to eNodeB. Table 6 illustrates how presented indicators relate to achieved performance.

Table 6: Performance indicator values

Performance	RSRP (dBm)	RSRQ (dB)	SINR (dB)
Excellent	> -75	> -9	> 20
Good	between -75 and -95	between -9 and -12	between 20 and 13
Fair	between -95 and -110	between -12 and -20	between 13 and 0
Bad	< -110	< -20	< 0

### 3.2 UE state management

MME has a key role when network is monitoring the state of all users with almost real-time accuracy. Each user is associated with two states from two different categories. These categories are defined in 3GPP 23.401 and are mostly independent of each other, however some relations do apply. EPS Mobility Management (EMM) states are used to describe whether the user is currently within the reach of the network or not. Two EMM states defined in [7] are EMM-DEREGISTERED and EMM-REGISTERED.

**EMM-DEREGISTERED:** MME does not hold valid location or routing information for UE. Since there is no information considering UEs current location, UE is not reachable by MME.

**EMM-REGISTERED:** UE enters to EMM-REGISTERED mode from EMM-DEREGISTERED through a successful attach procedure. In addition, a successful Tracking Area Update (TAU) can transition UEs state on MME to EMM-REGISTERED. When UE is in EMM-REGISTERED state, MME knows the location of the UE on a tracking area basis. In EMM-REGISTERED state, UE has always at least one active PDN connection and has set up security context required by EPS. UE transitions from EMM-REGISTERED to EMM-DEREGISTERED state through a successful detach procedure. MME can also reject incoming attach or TAU, or send an implicit detach to the UE after Implicit Detach Timer has expired. If all bearers associated to UE are released, MME changes state of the UE to EMM-DEREGISTERED.

The EPS Connection Management (ECM) state defines whether there is an active signaling connectivity between UE and EPC. Two EMC states defined in [7] are EMC-IDLE and EMC-CONNECTED.

**EMC-IDLE:** UE is in EMC-IDLE state, when there is no NAS signaling connection between UE and network. Also, no active S1-MME or S1-U connections exist for the UE when in EMC-IDLE mode. In a situation where UE is simultaneously in EMM-REGISTERED and EMC-IDLE state, UE performs various periodical operations. Some of the operations related to Intra-RAT operations are listed below. While in

the discussed state, the UE will for example:

- perform TAU if the current tracking area is not in the list of tracking areas that the UE has received from the network to maintain the registration and enable the MME to page the UE.
- perform periodic TAU procedure in order to notify EPC that the UE is available.
- answer to paging from MME by performing a service request procedure.
- perform service request procedure in order to establish radio bearers when uplink data is to be sent.

**EMC-CONNECTED:** UE will enter from EMC-IDLE to EMC-CONNECTED state when an active signaling connection is established between UE and MME. Messages that initiate this transition are Attach Request, Tracking Area Update Request, Service Request or Detach Request. In EMC-CONNECTED state, location of the UE is known by MME with accuracy of a serving eNodeB. Similarly to EMC-IDLE mode, UE performs TAUs in order to synchronize the list of TAs with MME. TAUs are also performed during handovers between cells inside E-UTRAN. When UE is in EMC-CONNECTED state, there is an active S1-MME and S1-U connection between UE and MME. Signaling connection is made up of two parts, which include a RRC connection and S1-MME connection. If the signaling connection is released, UE's state is changed back to EMC-IDLE mode. Transition between different states is illustrated in figure 15.

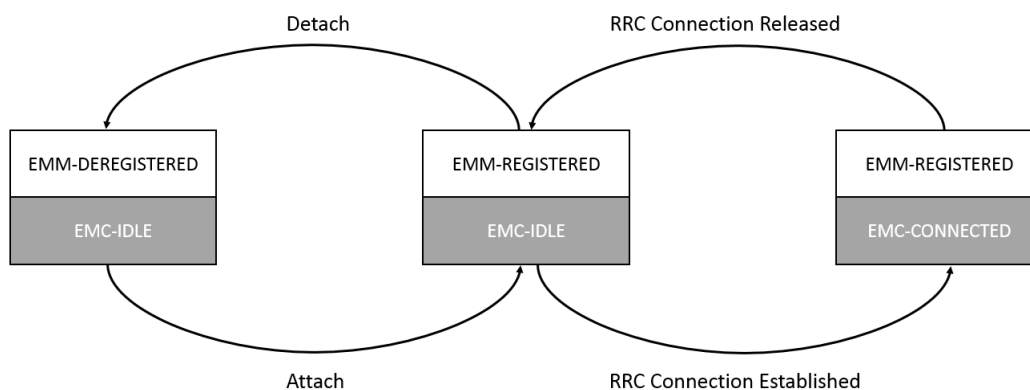

Figure 15: EMM and EMC state transitions [7]

### 3.3 Mobility management

User mobility is one of the main advantages brought by wireless technologies. Therefore, proper mobility management is required in order to guarantee that movement does not interrupt service regardless the fact that user might be communicating with several base stations within a short period of time. Mobility in LTE can be

divided in two basic categories: mobility in idle mode and mobility in connected mode. Mode is based on whether UE is in EMC-IDLE or EMC-CONNECTED mode, indicating that if the UE has an active data connection towards network or not. [15]

### 3.3.1 Idle mode mobility

UE is obligated to perform certain tasks in idle mode. These tasks can be subdivided to four different processes, which are PLMN (Public Land Mobile Network) selection, Cell selection and reselection, Location registration and Support for manual Closed Subscriber Group selection. First three processes are common within standard mobility, while the fourth process is mainly used when creating access lists within femtocells. [16]

When UE is powered on, Access Stratum (AS) function of the UE searches for available PLMNs within its capability range. Each mobile operator broadcasts its own PLMN identifier, which UE uses to determine distinguish networks from each other. Based on search results, AS selects suitable PLMN and forwards the information to NAS function. Selection can be based on predefined and prioritized list of suitable networks, or may be initiated manually. After suitable PLMN has been chosen, Cell selection begins. Selection will be done according to two selection processes: either Initial Cell Selection or Stored Information Cell Selection. Within Initial Cell Selection, no prior knowledge considering suitable cells is available. UE will then scan all capable radio channels and selects the most suitable cell. If UE has stored information from previous scans, it may use the Stored Information Cell Selection method and select suitable cell based on the stored information. Cell selection is based on following criteria [16]:

$$S_{rxlev} > 0 \ \& \ S_{qual} > 0 \quad (3)$$

$$S_{rxlev} = Q_{rxlevmeas} - (Q_{rxlevmin} + Q_{rxlevminoffset}) - P_{compensation} - Q_{tempoffset}$$

$$S_{qual} = Q_{qualmeas} - (Q_{qualmin} + Q_{qualminoffset}) - Q_{tempoffset}$$

$S_{rxlev}$  = Cell selection RX (Receiver) level value (dB)

$S_{qual}$  = Cell selection quality value (dB)

$Q_{tempoffset}$  = Cell specific temporary offset (dB)

$Q_{rxlevmeas}$  = Measured cell RX level value (RSRP)

$Q_{qualmeas}$  = Measured cell quality value (RSRQ)

$Q_{rxlevmin}$  = Minimum required RX level in the cell (dBm)

$Q_{qualmin}$  = Minimum required quality level in the cell (dB)

$Q_{rxlevminoffset}$  = Offset used when searching for higher priority PLMN

$Q_{qualminoffset}$  = Offset used when searching for higher priority PLMN

$P_{compensation}$  = Additional power compensation

After a suitable cell is found, UE performs attach to the chosen cell. If there is no need for immediate data transmission, UE starts to camp on the cell, meaning that UE listens to broadcasted control channel and waits for transmission to start.

Meanwhile it will receive tracking area information and paging messages within the registered PLMN. [16][17]

While in idle mode, UE may initiate Cell Reselection in order to obtain service from another cell. Reselection may be based on priorities assigned on different frequencies or on signal levels of available cells. Reselection measurements will be conducted if higher priority frequencies are available, or if the signal level of the serving cell drops below predefined thresholds. When UE performs reselection measurements, it uses a Ranking Method defined in [16]. Ranking system evaluates cells based on measured RSRP levels and offset values. If some other cell than the current serving cell is ranked as best cell, UE performs cell reselection process to the best ranked cell. [16]

$$R_s = Q_{smeas} + Q_{hyst} - Q_{tempoffset} \quad (4)$$

$$R_n = Q_{nmeas} - Q_{offset} - Q_{tempoffset} \quad (5)$$

$R_s$  = Rank for serving cell

$R_n$  = Rank for neighboring cell

$Q_{meas}$  = RSRP measurement quantity used in cell reselection

$Q_{offset}$  = Frequency specific offset between cells

$Q_{tempoffset}$  = Cell specific temporary offset

While UE is in idle state, MME is unaware of UEs location on cell specific level. As introduced in previous section, idle UE is able to receive paging messages from MME. Purpose of paging messages is to locate the cell UE is connected to in order to send traffic to UE. Paging procedure is done on Tracking Area (TA) basis, meaning that every cell belonging to certain TA sends a paging message through transport channel called Paging Channel, which is sent over PDSCH. If UE is within the coverage of cell belonging to paged TA, it will respond to paging and inform MME of its location. This procedure transfers UE from EMC-IDLE to EMC-CONNECTED state and prepares it to receive incoming downlink traffic. In order to keep MME updated on UEs location, UEs in idle mode will perform periodical TAUs based on expiration of specific TAU timer. TAU is also performed if UE moves between different TAs. Sending TAU message also switches UE from EMC-IDLE to EMC-CONNECTED mode until active signaling connection is released. [18]

### 3.3.2 Connected mode mobility

When in EMC-CONNECTED mode, UE has an active connection with EPC. To support the basic principles of mobility, this connection should not be interrupted even if UE moves between different cells. LTE uses hard handovers to move UE from cell to another. Hard handover means that UEs connection to source cell is torn down before a new connection to target cell is established. Handovers in LTE are classified as UE-assisted and network-controlled handovers, meaning that network makes the decision on whether to execute handover based on reports received from UE. Measurement Configuration provided by network defines what kind of information UE reports during mobility procedure. Measurement Configuration is delivered

during RRC signaling and includes following parameters:

**Measurement Object:** Defines objects on which UE shall perform measurements. Within E-UTRAN, objects are defined as individual carrier frequencies. It is also possible to configure cell specific offsets or define blacklisted cells, which are left out of the measurement report results.

**Reporting Configurations:** Is a list consisting of Reporting Criterion and Reporting Format. Reporting Criterion is a criterion that triggers UE to send measurement reports. This can be defined either as a periodical or event based criteria. Reporting Format defines quantities of reported measurement results, which can be for example number reported cells.

**Measurement Identities:** Is a list, where each measurement identity links one Measurement Object with one Reporting Configuration. Measurement Identity is then used as a reference number in the measurement report. Multiple Measurement Objects can be linked to a same Reporting Configuration by creating multiple Measurement Identities.

**Quantity Configurations:** Quantity Configuration defines measurement quantities and associated filtering used for evaluation.

**Measurement Gap:** Defines periods that UE may use to perform measurements. No uplink or downlink data is transmitted when UE conducts measurements. [19]

Based on Measurement Configuration, UE will perform RSRP and RSRQ measurements for currently serving primary cell and nearby neighbouring cells. Each measurement is recalculated with the following Layer 3 filtering formula:

$$F_n = (1 - a) * F_{n-1} + a * M_n \quad (6)$$

$F_n$  = filtered measurement result, which is used for evaluation

$M_n$  = latest measurement result from the physical layer

$F_{n-1}$  = old filtered measurement result

$a = 1/2^{(k/4)}$ , where k is the filter coefficient received within the Quantity Configuration. [19]

Layer 3 filtering creates a sliding average of the measured values. This prevents unwanted event triggering based on single deviant measurement result. Filtered values are reported to eNodeB based on periodic timer or triggering of a 3GPP defined Handover Event. These events are used to define situations, when a handover should be considered. Handover events are listed in table 7. [14][19]

Table 7: Handover Events [19]

<b>Event</b>	<b>Description</b>
A1	Serving becomes better than threshold
A2	Serving becomes worse than threshold
A3	Neighbor becomes offset better than Primary Serving Cell
A4	Neighbor becomes better than threshold
A5	Primary Serving Cell becomes worse than threshold 1 and neighbor becomes better than threshold 2
A6	Neighbor becomes offset better than Secondary Serving Cell
B1	Inter-RAT neighbor becomes better than threshold
B2	Primary serving Cell becomes worse than threshold 1 and inter-RAT neighbor becomes better than threshold 2

Concept of primary cell mentioned in the table 7 relates to a situation where Carrier Aggregation (CA) would be used for increased bandwidth. In CA, UE is simultaneously using Primary Serving and Secondary Serving Cells, which is why most current LTE release includes handover event A6 supporting secondary cell handover. CA is not covered within the scope of this thesis. When event is started, UE begins to send periodic measurement reports to serving eNodeB. These reports are sent until handover is issued, or events leave condition is fulfilled. Most commonly used handover event is event A3, since it evaluates conditions based on both, serving and neighboring cells. Handover events will be discussed in more detail in next chapter.

### 3.3.3 Signaling procedures

The scope of this thesis does not require understanding message flows of all signaling procedures related to EPS. However, understanding handover procedure is critical for the scope of this thesis and therefore handover signaling is covered in detail. 3GPP specified X2 interfaces between individual eNodeBs do not exist in the studied network, and therefore only S1 Handover is covered.

#### S1 Handover

Handovers in general are used when UE is moving from coverage of one cell to another. In order to transfer UE successfully, some form of signaling is required between source and target eNodeBs and MME. S1 handover procedure is used whenever two communicating eNodeBs are not connected with X2 interface. S1 handover is also required when UE is changing from one Radio Access Technology (RAT) to other. S1 handover procedure is defined in 3GPP 23.401 [7]. Figure 16 illustrates steps associated with S1 handover procedure. Figure is followed by detailed description of each step.

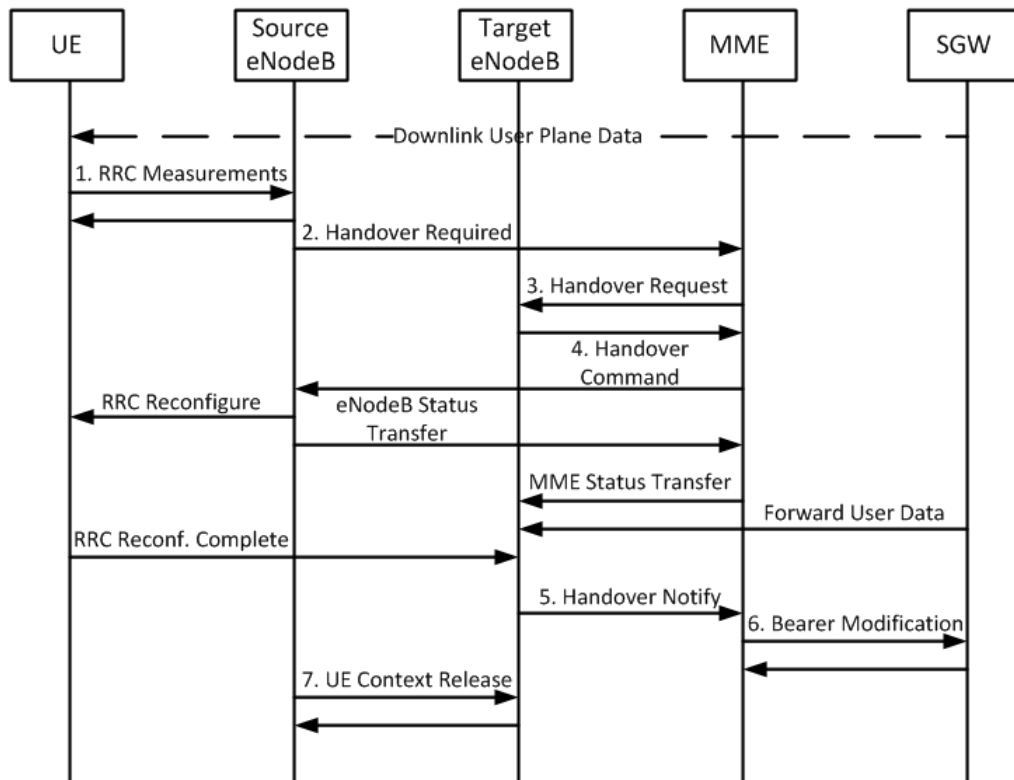

Figure 16: Handover signaling flow [7]

#### Step 1: RRC Measurement

Based on network provided Measurement Configuration, UE reports measurement results to Serving-eNodeB (SeNB), which uses pre-determined threshold values to calculate whether UE requires a handover to another cell.

#### Step 2: Handover Required

When handover criteria is met, SeNB makes handover decision and sends Handover Required message to MME. This message includes information considering the handover: handover type (Intra- or Inter-RAT), cause of the handover, information about Target-eNodeB (TeNB), already known information about UEs radio capabilities and information about the currently ongoing RRC connection with the UE. Especially information considering the current RRC session is important in order to established similar connection during at the TeNB.

#### Step 3: Handover Request

Upon receiving Handover Required –message from the SeNB, MME contacts TeNB to inform it about the incoming handover. This message is called Handover Request, and it contains same information that was sent from SeNB in the Handover Required –message. After TeNB has received the request, it allocates necessary radio resources for the incoming RRC connection. Information considering the new RRC connection has to be delivered to the UE in order for UE to establish connec-



tion to correct target cell. Therefore, TeNB delivers this information to MME with a Handover Request Acknowledged –message.

#### Step 4: Handover Command

After receiving confirmation from TeNB, MME sends Handover Command –message to SeNB. Handover Command –message includes information about the new RRC connection at the TeNB, which leads to triggering of RRC reconfiguration at the UE. At this point, UE performs the handover on physical layer, thus leaving the source cell and establishing connection to the target cell. As soon as UE has left source cell, SeNB sends a specific eNodeB Status Transfer –message to MME. This message contains information about last packets that were sent or received by SeNB for this specific connection. This way MME knows when user-plane data transfer has to be stopped at SeNB and started on TeNB. Same information is then forwarded from MME to TeNB with MME Status Transfer –message.

#### Step 5: Handover Notification

After UE has arrived to the target cell and new RRC connection has been set up, TeNB sends Handover Notification –message to MME indicating that the handover has been successful. This message contains information about the new cell and tracking area UE is now connected to, and is used to replace the existing location information in MME.

#### Step 6: Modify Bearer

During initial attach UE is associated with a GTP-tunnel, which forwards traffic through EPC. Since UE has changed eNodeB it is connected to, endpoint of the assigned tunnel has to be changed too. However, it is only necessary to switch the downlink direction endpoint from SeNB to TeNB, since uplink direction endpoint usually remains unchanged. This procedure is done with Modify Bearer Request –message sent from MME to SGW, and it contains information about new downlink endpoint for this specific GTP connection. As soon as SGW has made required changes, it informs MME with Modify Bearer Response –message.

#### Step 7: UE Context Release

The last step of S1 Handover procedure is to release the reserved resources from SeNB. This action is triggered by MME with UE Context Release Command. After transport resources and radio resources have been released, SeNB informs MME about the completion with specific UE Context Release Complete –message.

Other common information flows that have been specified in 3GPP standard [7]

### **Initial attach procedure**

Initial attach procedure is used when UE connects to network without prior connection, meaning that it is in EMM-DEREGISTERED state. This can happen for example when UE has been powered off or has been out of networks coverage for a longer period of time. In order to establish connection to network, UE must initiate

signaling with EPC. This initial registration signaling is called attach procedure, and has to take effect before users are able to access services provided by network.

### **UE Context Release Request**

UE Context Release Request is a procedure, which is used when network detects that UE has been inactive for a certain period of time. This period is calculated with specific timers, which at the point of expiration may release the UE context created between eNodeB and MME. Context release may also occur in conditions where network has lost the radio connection to UE. Context release procedure is considered as a preserving procedure; removing the S1AP context releases radio resources from eNodeB, which improves the overall service level of network.

### **UE Service Request**

Context release initiated by eNodeB does not result in UE losing attach with the network. Therefore, default bearer is still logically set up and active waiting for UE to transmit or receive data. When UE desires to transmit or receive data, service request message is transmitted on NAS layer, and UE context is set up in order to pass traffic to UE.

### **Dedicated Bearer Setup**

During initial attach, each user is set up with a default bearer. Default bearer is formed according to networks service policies, and is similar on all connections in the network. Some users however do require differentiated services, which include for example differently configured QoS profile. In order to apply different QoS policy over the user plane, desired subscriber is set up with a dedicated bearer. Most often, dedicated bearer procedure is triggered by decision made by PCRF through Gx interface between PGW and PCRF. In a typical scenario user might be surfing the web and watching streamed videos while having a simultaneous VoIP (Voice-over-IP) conversation. In order to satisfy needs of different applications, default bearers may be created in order to offer guaranteed bit rates or similar qualities for users.

### **Dedicated Bearer Release**

Since dedicated bearers are created based on demand, it is also required that those bearers have a release mechanism in order to delete bearers that are no longer needed.

### **Detach**

Detaching a subscriber from network corresponds the action of deleting registered subscribers from the active user database of MME. Usually detach occurs when UE has not performed periodic tracking area updates requested by network, and therefore network considers UE as inactive. Network originated detach procedure is initiated by MME, which is the network element in responsible for tracking subscriber locations. Detach results in a deletion of bearers in PGW and releasing UE context on eNodeB. If UE is still able to receive messages from network, it is informed about the detach. In addition, HSS is informed that the UE is no longer registered to network. If necessary, detach can also be triggered by UE.

## 4 Mobility performance in studied LTE network

The main focus of this chapter is to introduce the studied network structure and its characteristics related to handover performance. First section describes metrics used in handover performance evaluation and discusses differences between desires of individual users and network operator. Second section introduces the studied frequency bands in more detail and points out some of the most important differences in their capabilities. Third section describes how handovers are conducted in the studied network. Fourth section consists of a preliminary analysis, which is done based on described network structure and theoretical background information provided in previous chapters. Preliminary analysis also includes the description of initial measurements, which were conducted in order to derive suitable threshold values for the handover strategy used during performance analysis.

### 4.1 Handover performance indicators

Network operators and users tend to evaluate network performance from different perspectives. Network operators have to evaluate both technical quality and commercial profitability of network. By investing large sums on network equipment and spectrum resources, network operators could provide highly functioning services with overscaled resources. However, since commercial limitations do often apply, network equipment and base stations have to be allocated where they are required most. These decisions are often guided by variables like amount of population, achievable Average Revenue Per User (ARPU), construction costs, operational costs and many more. Therefore many network solutions combine different type of resources to provide best possible combination to satisfy user requirements. In practice, this can be seen as deployment of high capacity sites on areas with higher demand, or as absence of latest technology and holes in coverage on rural areas. Some of these decisions may impact followed metrics like handover success rate or average RSRP and throughput, but simultaneously improve operators profitability. Since user experience is in high value, network operators cannot neglect network development. By optimizing network layout and configuration, significant improvements can be made to network quality without commercial investments. One of the opportunities for optimization lies within handovers, where network operators can easily conduct load balancing and usage optimization. Through handovers, network operators can define desired service quality through several KPIs ranging from RSRP to amount of dropped sessions.

Users are usually unaware of such performance indicators, that are followed by network operators. Most often well functioning handovers are invisible to users, since the purpose of handover is to guarantee continuous service to mobile users without interruptions and drops in service quality. Users are therefore most likely to evaluate handover performance based on handover success rate and number of dropped connections. These metrics are difficult for users to track and mostly visible for network operators. Therefore some other metrics are required in order to track performance on user side. These metrics could be:

- Throughput
- Latency
- UE Power usage
- Number of handovers
- Amount of TCP retransmission
- UDP packet loss

From these metrics end users have best visibility towards throughput and latency, since they are visible metrics during Internet browsing and can be measured with most common tools found within the web. As discussed in previous chapters, achieved throughput in LTE networks is mostly affected by serving cells configuration, radio conditions and number of users sharing same bandwidth resources.

UE power usage is mainly affected by level of transmission power UE is forced to use. In bad radio conditions, UE has to transmit with higher power, which increases power consumption and shortens UEs battery life. Power usage highly effects the usability of mobile devices, but since UEs available for 450 MHz network are mostly other than handheld mobile phones, power usage is not considered as a good metric within the scope of this study.

Since handover execution should occur without interruptions in users data flow, users are most likely unaware of handover occurrences. Network operators are likely to follow the number of handovers, since unfitting number of handovers indicates issues within radio planning and coverage. Too low number of handovers and simultaneously growing number of session interruptions indicates insufficient coverage or too demanding handover parameters. On the other hand, too high number of handovers may indicate overlapping cell coverages or too low thresholds in handover configuration.

During traditional web surfing, where individual web pages are downloaded only during page change, handovers are hard to monitor. However, if a continuous TCP or UDP session is created, amount of TCP retransmission and UDP packet loss can be used as a good measure when determining whether handover was conducted successfully without interruptions. Since user perception is important in terms of customer satisfaction, this thesis focuses on the analysis off throughput and stability of the achieved service. Measurements will be conducted by monitoring the achieved throughput and latency in addition with monitoring the stability of the system through TCP performance.

## 4.2 Network characteristics

Handover triggering, measurements and signaling vary depending on the type of handover under discussion. Handovers are usually categorized depending on the attributes of source and target cells. Most often categorization is based on whether discussed attribute is positioned within same system or not, meaning that whether the attribute is intra- or inter-attribute. In studied context, intra means that the studied attributes are placed within same system, or are similar with each other. Contrary, inter means that these attributes are placed within different systems,

or are different from each other. Each handover can be categorized with values represented in table 8.

Table 8: Handover categorization

Intra-RAT	Handover within same technology (LTE/UMTS/etc.)
Inter-RAT	Handover between different technologies
Intra-MME/SGW	Connected MME/SGW is not changed during handover
Inter-MME/SGW	Connected MME/SGW is changed during handover
Intra-eNodeB	Handover between two cells residing within same eNodeB
Inter-eNodeB	Handover between two cells located in different eNodeBs
Intra-Frequency	Source and target cells are using same frequency
Inter-Frequency	Source and target cells are using different frequencies

Handovers between different RATs are conducted according to 3GPP specification [7]. For example, handover between E-UTRAN and UTRAN requires signaling between MME and SGSN, where SGSN is MME equivalent network element from UTRAN core structure. Many network solutions utilize geographically and logically divided core networks. In such cases, certain eNodeBs may be connected with different SGWs, while different MMEs might be responsible for location management on different areas. Handover between different MMEs and SGWs utilize S1 handovers, since some signaling is required between associated MMEs. If the handover occurs only between two eNodeBs, and no changes are made within EPC associations, eNodeBs may utilize X2 interface if available. Otherwise S1 interface is used. Handovers studied in this thesis are considered as intra-RAT, intra-MME, intra-SGW, inter-eNodeB and inter-Frequency handovers. In practice, this means that the studied handovers are conducted in the same LTE network, but between different eNodeBs utilizing different LTE frequencies. All handovers are S1 handovers. Even though that source and target cells are utilizing different duplex methods, FDD and TDD, handovers are still considered as inter-Frequency handovers instead of being characterized as handovers between different technologies.

Standard network structure consists of multiple homogenous macro-sized base stations. If more capacity is required, these macro sites can be densified by adding more sectors per base station. Another option is to add deploy more base stations within same geographical area. However, this approach has its limits mainly caused by inter-site interference and rapidly increasing deployment costs. Alternative approach is to deploy so-called micro-sites to cover holes within coverage area and to improve capacity in locations of high demand. These micro-sites may use same spectrum resources, but operate with limited coverage and smaller transmission power, thus reducing capacity usage on larger macro-sites. This type of network structure is called Heterogeneous Network (HetNet). Most official descriptions define HetNet as a structure, where macro-sites operated with high transmission power have relatively large (10 – 50 km) cell sizes, whereas micro-sites operate with low transmission power and smaller coverage areas (100 m – 2 km). Deploying HetNet

solution requires more complex network planning and mobility management, but offers substantial gains in capacity and performance, while simultaneously saving spectrum resources. LTE specifications have introduced various features to support HetNet solutions. For example, Release 8 specified Inter-Cell Interference Coordination (ICIC) to reduce interference between adjacent cells, while Release 9 introduced separate Home-eNodeBs to be used within small areas. In addition, Coordinated Multipoint (CoMP) introduced in Release 11 enabled UEs to communicate with two eNodeBs at the same time. [20] [21]

Another solution for expanding network capacity is to deploy base stations operating on different frequency bands to cover same geographical area. This solution can also be referred as Multi-Band Same-Coverage network, and it eliminates the effect of interference caused by overlapping cells. This type of network structure enables network operators to conduct load balancing between different bands through mobility management and network planning. However, in this kind of solution UEs have to support multiple frequency bands. This study is conducted on said Multi-Band Same-Coverage network, where eNodeBs have been deployed utilizing two different LTE frequencies, namely Band 31 and Band 38. Band specifications can be seen on table 9.

Table 9: Band specifications [22]

<b>Band</b>	<b>Duplex</b>	<b>Uplink Band</b>	<b>Downlink Band</b>	<b>Bandwidths</b>
B31	FDD	452.5 - 457.5 MHz	462.5 - 467.5 MHz	1.4, 3, 5 MHz
B38	TDD	2570 - 2620 MHz	2570 - 2620 MHz	5, 10, 15, 20 MHz

Since the studied network is built by using two different frequency bands, it is not categorized as a heterogeneous network. However, it has many similar qualities. For example, B31 is able to provide significantly larger cell sizes, thus acting as macro-sites when compared to significantly smaller B38 cells. Simultaneously B31 cells are able to provide less throughput for single users because of bandwidth limitations. Therefore, generalizations and comparisons with the concept of heterogeneous network will be made to some degree.

Used frequency bands have different characteristics in terms of throughput and stability. Throughput is mainly dependable on number of available PRBs and achieved modulation scheme. Modulation scheme is based on received signal quality, while the number of PRBs depends on network load and configuration. This means that bands supporting higher bandwidths are also supporting higher data throughputs. Table 10 represents achieved maximum downlink throughputs with FDD and TDD duplex methods while utilizing bandwidths of 5 MHz and 20 MHz with normal cyclic prefix length. These throughput values are not achievable in practice, but can be used as informative values when projecting possible outcomes. Table 10 shows that FDD is able to provide much better downlink throughput than TDD, even if values for TDD are introduced with best possible scenario. This is caused mainly by overheads generated by signals not carrying any downlink data in TDD. However,

as seen in table 9, B31 is only specified with maximum of 5 MHz bandwidth making total achievable downlink throughput in B31 only 100 Mbps. B38 on the other hand is specified with maximum of 20 MHz bandwidth, thus being able to provide up to 325 Mbps. [23]

Table 10: Throughput on studied bandwidths [23]

FDD			TDD		
Modulation	5MHz	20 MHz	Modulation	5MHz	20 MHz
QPSK	8.4 Mbps	33.6 Mbps	QPSK	7.4 Mbps	29.9 Mbps
16QAM	16.8 Mbps	67.2 Mbps	16QAM	14.8 Mbps	59.8 Mbps
64QAM	25.2 Mbps	100.8 Mbps	64QAM	22.2 Mbps	89.7 Mbps
2x2 MIMO	50.4 Mbps	201. Mbps	2x2 MIMO	42.5 Mbps	172.2 Mbps
4x4 MIMO	100.8 Mbps	403.2 Mbps	4x4 MIMO	80.3 Mbps	325.0 Mbps

Users perceive achieved modulation as descending or ascending data rates. Modulation is mainly dependable on signal quality, which is affected by strength and interference of received signal. Single base station can only cover a limited geographical area and serve a limited amount of users simultaneously. When user is far away from base station, or when attached cell is experiencing heavy load, user perception of achieved service gets worse. Cell size is mostly determined by cell configuration and propagation characteristics of used frequency. In reality, many issues like antenna placement and weather conditions affect the maximum distance mobile service can be received from. However, some theoretical reference distances can be calculated using LTE specifications and radio propagation models. Maximum cell range of LTE cell is dependable on the following factors: cyclic prefix, which was discussed in chapter two, preamble format and guard period used in TDD.

Preamble format, defined in 3GPP 36.211 [12], is related to PRACH configuration that UE uses when establishing RRC connection during attach or handover. Preamble format defines the length of physical layer access preamble within time domain. Preamble consists of two parts: Cyclic Prefix  $T_{cp}$  and Sequence part  $T_{seq}$ , of which lengths are defined in sampling intervals  $T_s$ . In order to calculate maximum cell range, the length of preamble is reduced from total length of subframes reserved for random access procedure, thus forming a guard time. Length of the guard time defines the distance that electromagnetic signal can travel back and forth at the speed of light until time reserved for random access procedure runs out. Table 11 introduces different preamble format configurations and derives maximum cell ranges for each configuration.

Table 11: Preamble formats [12]

Preamble format	$T_{cp}$ (in $T_s$ )	$T_{seq}$ (in $T_s$ )	Length (in ms)	Subframes occupied	Guard time (in ms)	Cell radius
0	3168	24576	0.903	1	0.097	15 km
1	21024	24576	1.484	2	0.516	77 km
2	6240	49152	1.803	2	0.197	29 km
3	21024	49152	2.284	3	0.716	107 km

**Cell radius** =  $c * \text{Guard time (s)} / 2$

**Speed of light,  $c$**  = 299792458 m/s

**$T_s$**  =  $(1 / 15000 * 2048)$  seconds

**Subframe** =  $30720 T_s$

As mentioned in chapter two, Frame structure type 2 used in TDD duplex method includes additional GP, which creates a limitation for cell ranges in TDD. Table 4 in section 2.4.5 described the different subframe assignments used in TDD, each including one or two special subframes consisting of three parts, DwPTS, UpPTS and GP. Separate special subframe configuration defined in [12] is used to define the lengths of these three parts of special subframe. Similarly to guard time in preamble format, GP in each special subframe defines the maximum achievable cell range in TDD. Cell range limitation caused by special subframes when using normal cyclic prefix lengths are presented in table 12.

Table 12: Special subframe configuration [12]

Special subframe configuration	DwPTS (in $T_s$ )	UpPTS (in $T_s$ )	GP (in $T_s$ )	GP (in ms)	Cell radius
0	6592	2192	21936	0.714	107 km
1	19760	2192	8768	0.285	43 km
2	21952	2192	6576	0.214	32 km
3	24144	2192	4384	0.143	21 km
4	26336	2192	2192	0.071	11 km
5	6592	4384	19744	0.643	96 km
6	19760	4384	6576	0.214	32 km
7	21952	4384	4384	0.143	21 km
8	24144	4384	2192	0.071	11 km
9	13168	4384	13168	0.429	64 km

**Cell radius** =  $c * \text{Guard time (s)} / 2$



As the cell configuration defines maximum range in which UE is still able to communicate with eNodeB without overlapping transmissions, actual cell range is also limited by propagation and loss occurring within transport medium. In case of cellular networks, the transport medium is air. Since air provides little to none resistance towards electromagnetic radiation, occurring loss can be assumed as Free Space Path Loss (FSPL). Formula of FSPL is defined by IEEE in [24] as the “loss between two isotropic radiators in free space”. However FSPL is not often seen fit enough for radio propagation modeling, since in reality radio signals are not travelling in free space, but instead in an environment filled with buildings and vegetation. Most commonly used propagation loss model is considered Okumura-Hata model [25], which introduced an empirical propagation model including different correlations for urban, suburban and rural environments. Following formula represents the Okumura-Hata model applicable in small cities.

$$L_p = A + B * \log(R) \quad (7)$$

$$A = 69.55 + 26.16\log(f) - 13.82\log(h_{BS}) - a(h_{MS})$$

$$B = 44.9 - 6.55\log(h_b)$$

$L_p$  = Path Loss (dB)

$R$  = Distance from the transmitter (km)

$f$  = Operating frequency (MHz)

$h_{BS}$  = Height of the transmission antenna (m)

$h_{MS}$  = Height of the receiver antenna (m)

$a(h_{MS}) = (1.1\log(f) - 0.7) * h_{MS} - 1.56\log(f) - 0.8$

Okumura-Hata model was originally applicable for frequencies under 1500 MHz and distances under 20 km, but the model is often extrapolated to frequencies up to 3 GHz and distances up to 100 km. Even if Okumura-Hata model offers substantially accurate predictions on propagation loss, many variants have been made in order to fit the model on varying situations. One of these models is COST-231 model [26], which expands the frequency range to cover frequencies between 1500 MHz and 2000 MHz. COST-231 model modifies the A variable of the original Okumura-Hata model:

$$A = 46.3 + 33.9\log(f) - 13.82\log(h_{BS}) - a(h_{MS}) \quad (8)$$

By utilizing the original Okumura-Hata model for 450 MHz frequency and COST-231 model for 2600 MHz, we can determine maximal cell sizes if a standard path loss is assumed. Path loss is calculated based on transmitter power, antenna gain and propagation loss. Path loss is also dependable on the sensitivity capabilities of utilized equipment, and therefore has different values depending on chosen setup. If total path loss of 180 dB is used, presented formulas would suggest that 450 MHz and 2600 MHz cells have maximum cell ranges of 110 km and 20 km, respectively. As mentioned, neither of these models are fully applicable for the studied frequencies. Original Okumura-Hata model is limited to cell ranges under 20 km,

while COST-231 model is applicable only to frequencies between 1500MHz and 2000 MHz. Therefore it is likely that results achieved by either of the models may have deviations ranging between 15 - 30 dB. However, results give a good overall understanding on differences within propagation characteristics of the studied frequencies.

Cell radius is also limited by the earth's curvature, since only a certain line-of-sight distance can be achieved. Line-of-sight distances can be derived from the Pythagoras theorem. When considering a base station antenna at the height of 250 m above ground level, maximum cell range of 66 km can be achieved. In reality, radio signals bend and reflect from different surfaces and are therefore able to travel longer distances, which is why this limitation is left out of consideration.

### 4.3 Handover strategies

Vendors are capable of implementing mobility management in different manners, as long as implementation follows 3GPP specifications. Device manufacturer of the studied network has categorized mobility in two main categories: intra-frequency mobility and inter-frequency mobility. Since intra-frequency handovers are often related to macro-only network structures, they are conducted solely with handover event A3 and without prior measurement events. Inter-frequency handovers on the other hand use different handover event combinations based on what kind of handover strategy is preferred in each situation. Handover strategies are based on either coverage, desired service, distance, uplink-quality or frequency-priority. A brief analysis was made considering all available strategies:

- **Coverage-based handover strategy** is considered as a default strategy, since it ensures continuous service for UE by measuring downlink channel quality. Other strategies can be used if necessary.
- **Service-based strategy** offers variation depending on QCI (QoS Class Identifier) values. This strategy but will not be studied since the studied network does not use QCI differentiation between cells.
- **Distance-based strategy** enables triggering of handover based on UEs distance from base station. This strategy requires thorough planning, since cell sizes may vary based on site placements and antenna heights. This strategy will not be studied within the scope of this thesis, since it does not offer desired high level solution.
- **Uplink-quality-based strategy** is similar to coverage-based strategy, but evaluates signal quality in uplink direction instead of downlink direction. This strategy is considered useful for overall network performance and user experience, since reduced uplink-quality may lead to a bad service performance even if downlink channel strength has not weakened. However, it is not studied within the scope of this thesis, since more emphasis is given on downlink direction.
- **Frequency-priority-based strategy** offers a way of transferring UEs from lower bands to higher bands in order to conduct load balancing. Handovers back from high band to low band are then conducted as a coverage-based

handovers. This strategy has two types of measurement triggering events depending on whether the neighboring cells are covering the same or different geographical areas.

Based on these findings, further studies were made on coverage-based strategy and frequency-priority-based strategy. As mentioned, inter-frequency handover schemes are using different combinations of handover events in order to achieve required performance. Each strategy includes a triggering and stopping event, which are used to start and stop inter-frequency measurements. This means that UE will not start inter-frequency measurements until one of measurement trigger events has occurred. Only after that UE will send measurement information towards network. Network then uses separate handover events to decide whether handover is conducted. Table 13 represents events used in the studied strategies.

Table 13: Handover strategies

<b>Scheme</b>	<b>Measurement triggering event</b>	<b>Measurement stopping event</b>	<b>Handover decision</b>
Coverage-based strategy	A2	A1	A3, A4 or A5
Frequency-priority same-coverage	A1	A2	A4
Frequency-priority different-coverage	A2	3 sec timer	A4

As it is shown in table 13, events A1 and A2 serve only as measurement triggering events within the scope of these inter-frequency strategies. Definitions of events A1 and A2 are opposite of each other, which means that as in the case of coverage-based handover strategy, event A2 is used to start handover measurements and event A1 is used to stop the measurements. Coverage-based handover decision is then based on one of the selected events A3, A4 or A5. Frequency-priority measurements on the other hand can be triggered by either of these two measurement events depending on whether handover occurs on same-coverage or different-coverage topologies. As event A1 is triggered when "serving becomes better than threshold", it is used as a measurement trigger when UE is approaching eNodeB offering service on both frequencies. In such case, measurements are triggered when RSRP of serving low frequency cell goes over certain A1 threshold, meaning that it is likely that there is a higher frequency cell to be found. Event A2, "serving becomes worse than threshold", is then used as a measurement trigger in different-coverage scenarios, where RSRP of serving low frequency cell deteriorates below certain A2 threshold. As mentioned, frequency-priority handovers apply only when conducting handovers from lower frequency towards higher frequency. On the opposite direction handovers are always conducted as coverage-based handovers. Figure 17 illustrates the difference between these handover strategies.

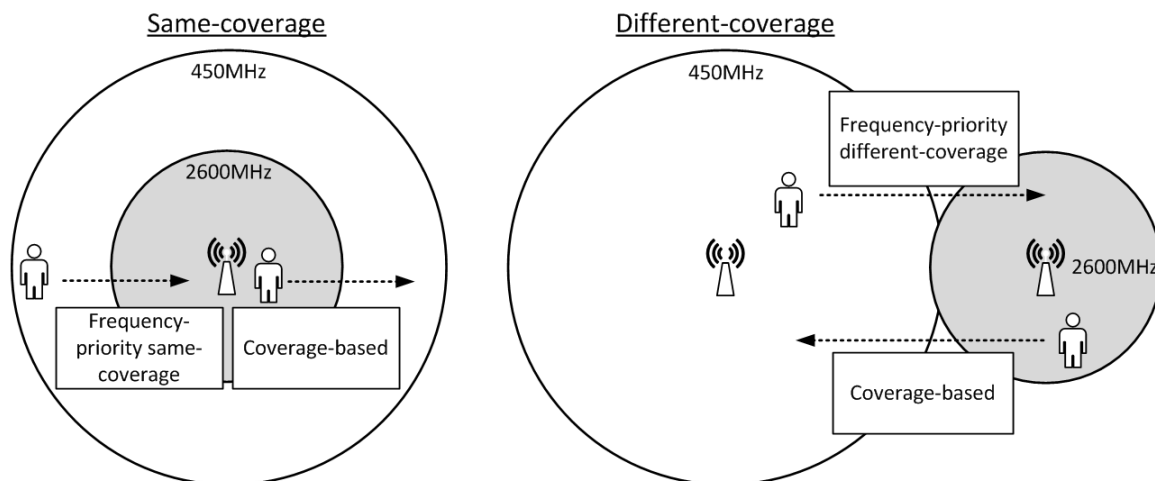

Figure 17: Handover schemes in same-coverage and different-coverage topologies

Each handover event has a certain entering and leaving condition, which are used to define whether the event is triggered or not. These conditions are primarily based on following values:

- **Threshold**, which is operator defined threshold value for fulfilling conditions within event.
- **Offset**, which is used to make certain cell look better than it really is.
- **Hysteresis**, which is used to make certain cell look worse than it really is.
- **Time-To-Trigger (TTT)**, which is a timer that has to expire before before event is triggered.

These values are sent to UE within measurement configuration, which can be modified by network operator. Most of the values are represented in dB, with an exception of threshold value for RSRP, which is given in dBm. Possible offset values used by the manufacturer of the studied network range from -24 dB to 24 dB, while hysteresis is specified as always positive integer between 0 and 15 dB. TTT is measured in milliseconds, and can be set to one of the following values: 0, 40, 64, 80, 100, 128, 160, 256, 320, 480, 512, 640, 1024, 1280, 2560, 5120 ms. By using these values, table 14 describes entering and leaving conditions for each handover event. [19]

Table 14: Handover event entering and leaving conditions [19]

Event	Description
A1	Serving becomes better than threshold
Entering Condition	$M_s - Hys > Thresh$
Leaving Condition	$M_s + Hys < Thresh$
A2	Serving becomes worse than threshold
Entering Condition	$M_s + Hys < Thresh$
Leaving Condition	$M_s - Hys > Thresh$
A3	Neighbor becomes offset better than serving
Entering Condition	$M_n + O_{fn} + O_{cn} - Hys > M_p + O_{fp} + O_{cp} + Off$
Leaving Condition	$M_n + O_{fn} + O_{cn} + Hys < M_p + O_{fp} + O_{cp} + Off$
A4	Neighbor becomes better than threshold
Entering Condition	$M_n + O_{fn} + O_{cn} - Hys > Thresh$
Leaving Condition	$M_n + O_{fn} + O_{cn} + Hys < Thresh$
A5	Primary Serving becomes worse than threshold 1 and neighbor becomes better than threshold 2
Entering Condition	$M_p + Hys < Tresh1$ and $M_n + O_{fn} + O_{cn} - Hys > Tresh2$
Leaving Condition	$M_p - Hys > Tresh1$ or $M_n + O_{fn} + O_{cn} + Hys < Tresh2$

$M_s$  = Measurement result of the serving cell (dBm with RSRP, dB with RSRQ)

$Hys$  = Hysteresis for certain event (dB)

$Thresh$  = Threshold for certain event (same unit with  $M_s$ )

$M_n$  = Measurement result of the neighbouring cell

$O_{fn}$  = Frequency specific offset for the neighbouring cell (dB)

$O_{cn}$  = Cell specific offset for the neighbouring cell (dB)

$M_p$  = Measurement result of the primary serving cell

$O_{fp}$  = Frequency specific offset for the primary serving cell (dB)

$O_{cp}$  = Cell specific offset for the primary serving cell (dB)

To give a better understanding on the studied phenomena, a standard coverage-based inter-frequency handover is represented in figure 18. When UE moves within coverage area, at some point signal level of serving cell starts to deteriorate. When enter condition for event A2 is met, TTT is counter is started. If the enter condition is still true after the counter has expired, event A2 is triggered, meaning that UE will start performing inter-frequency measurements. UE then reports obtained measurement results to network, and when suitable cell fulfilling enter condition for event A4 is found, TTT specified for event A4 is started. After the expiration of TTT timer, network may decide to conduct handover if the enter condition for target cell is still valid. If UE does not receive handover indication from currently serving eNodeB, and the measurement condition is still valid, UE will keep sending measurement reports at predefined measurement interval. Handover can be postponed

for multiple reasons, including for example rejection from candidate cell. UE will stop measurements if handover measurement stopping event occurs before handover is executed.

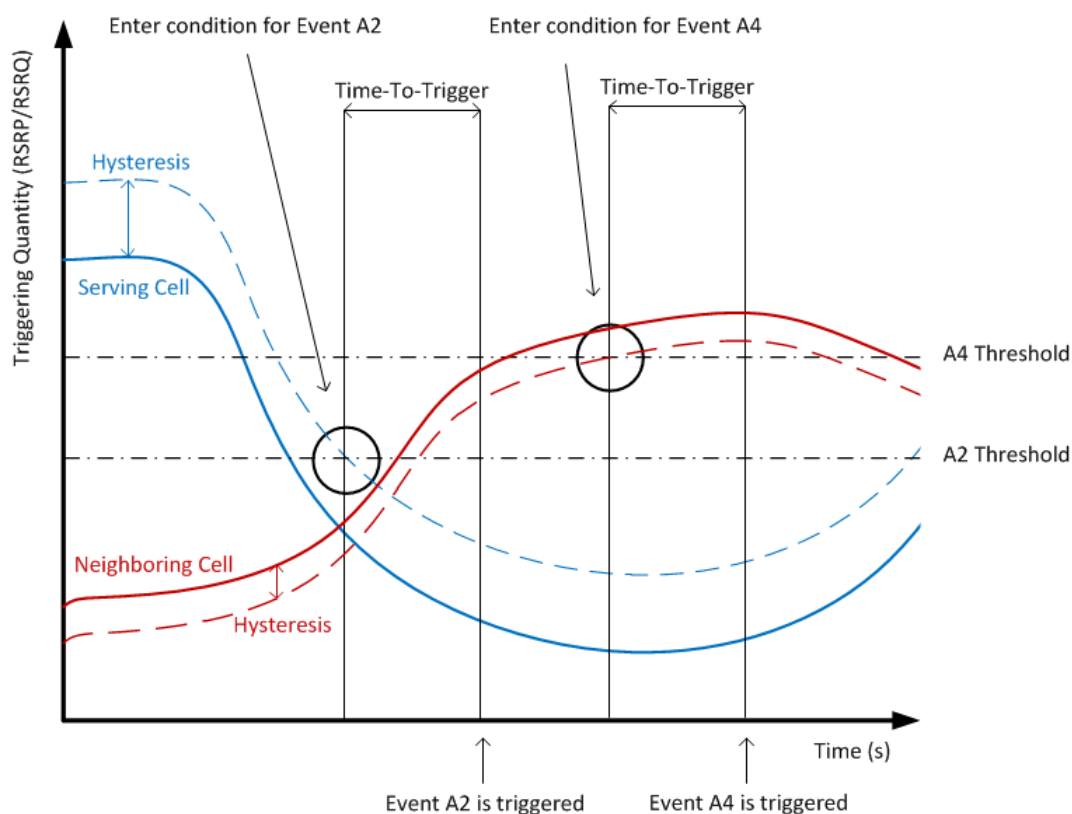

Figure 18: Triggering of events A2 and A4

As handover decisions made by eNodeBs are based on the introduced events and their conditions, desired changes and improvements on handover behaviour have to be made within these parameter values. Device manufacturers introduce certain default configuration values, which are usually meant for macro-only networks. Default values do not account differences in network topologies and frequency combinations. This is logical, since device manufacturer is usually not able to foresee what kind frequency combinations each eNodeB is going to utilize. Device manufacturers offer network optimization services within their service portfolio, but if such service is not negotiated, optimization falls under network operators responsibility. It is most likely that networks will become more and more autonomous in near future, and can automatically optimize their own configuration depending on available resources. But until then, some manual configuration is required. Before optimization can be conducted, network operator has to have substantial knowledge on the networks characteristics. These characteristics include for example user behaviour, characteristics of deployed frequencies, coverage formed by each frequency and capabilities of chosen equipment. Users might be moving with a car or a train, and therefore at different speeds. Different frequency combinations may cause interfer-

ence with each other, have different propagation capabilities or may have different capabilities in terms of available resources. Some devices may also have a lower sensitivity characteristics than others. These are all characteristics that cannot be taken into account within default parameters. Therefore if proper optimization is desired, these characteristics have to be studied and taken into account. Some of the parameters have been represented earlier in this chapter, and some will be studied in detail in the following section. Last section of this chapter focuses on introducing the proposed handover parameter values for the studied network.

Many default measurement configurations introduced by device manufacturers include only RSRP based measurements, meaning that handover decision is solely based on received signal strength and is not taking received signal quality into account. Same scenario also applies to the studied network, since as default eNodeBs utilize only RSRP measurements during inter-frequency handovers. Many studies have been conducted on handover triggering parameters, and often conclusions point to a joint solution where both RSRP and RSRQ should be utilized to gain best performance for end users. For example, Kazmi et al. [27] evaluated inter-frequency handovers with various scenarios, where two scenarios introduced handover triggering based solely on RSRP and solely on RSRQ. Third scenario then utilized both quantities. Study concluded that handover scenarios entirely based on RSRP lead to a poor performance when compared to scenarios involving also RSRQ measurements. Study also concluded that schemes based solely on RSRQ resulted only in slight performance improvement when compared to solely RSRP based measurements. Best results were obtained by utilizing both RSRP and RSRQ as handover measurement metric. Similar findings were made by Petrut et al. [28], who found out that by utilizing RSRQ as a handover parameter in heterogeneous networks, it is possible to gain improvements in achieved throughput and to reduce UE power consumption through lowered transmit power requirements.

Deciding on suitable handover parameter values is based on desired handover performance and is greatly dependable on existing network structure. Mehta et al. [29] have conducted a study comparing effects of offset and TTT values on heterogeneous networks. Main purpose of the study was to find suitable parameter values in a way that UEs could spend as much time in smaller pico-cells as possible, while simultaneously avoiding handover failures between cells. Spending time in pico-cells instead of macro-cells saves resources from contested macro-cells, and is more likely to offer users with better service. In their study, Mehta et al. found out that when using large and positive offset values, which are often used in macro-only deployments, a greater number of handover failures occur in heterogeneous networks especially when moving from smaller cells to larger cells. Small and negative offset values however created ping-pong effect between cells, which means that cell specific offset values are required for proper load balancing in heterogeneous networks. Most time spent on small pico-cells was achieved with small TTT values and large cell specific offset values for pico-to-macro handovers.

#### 4.4 Preliminary analysis

In order to derive most suitable handover parameter values, preliminary analysis was made with same functional network equipments that would be used during the actual measurements. Preliminary measurements were conducted with Atel ALR-U276 LTE CPE supporting both bands B31 and B38. Additionally, external antennas with 3 dB gain were used. Over-The-Air (OTA) tests have been conducted on the chosen CPE by Verkotan Oy [30] according to test methodology created by 3GPP [31]. One purpose of OTA testing is to define Total Radiated Sensitivity (TRS) of the device in each frequency. TRS has been defined in [32], but it can be treated as a lowest possible signal level that the device is able to use for communication. OTA tests concluded with similar reference antennas found out that on B31, TRS of the CPE was -99.2 dBm, while on B38 TRS was only -88.1 dBm. This means that the CPE is more sensitive on B31, and thus is able to communicate on B31 with lower signal levels when compared to B38. In other words, more stable service can be expected when communicating through B31.

In earlier section it was decided to use data throughput as the main indicator of achieved service level. Therefore initial measurements were made to determine what kind of service the studied network would be able to provide with the available equipment. First, measurements were conducted in order to see how level of RSRP affected achieved throughput. Results can be seen on figure 19, where individual dots represent measurement points and the drawn line illustrates the trend between throughput and RSRP.

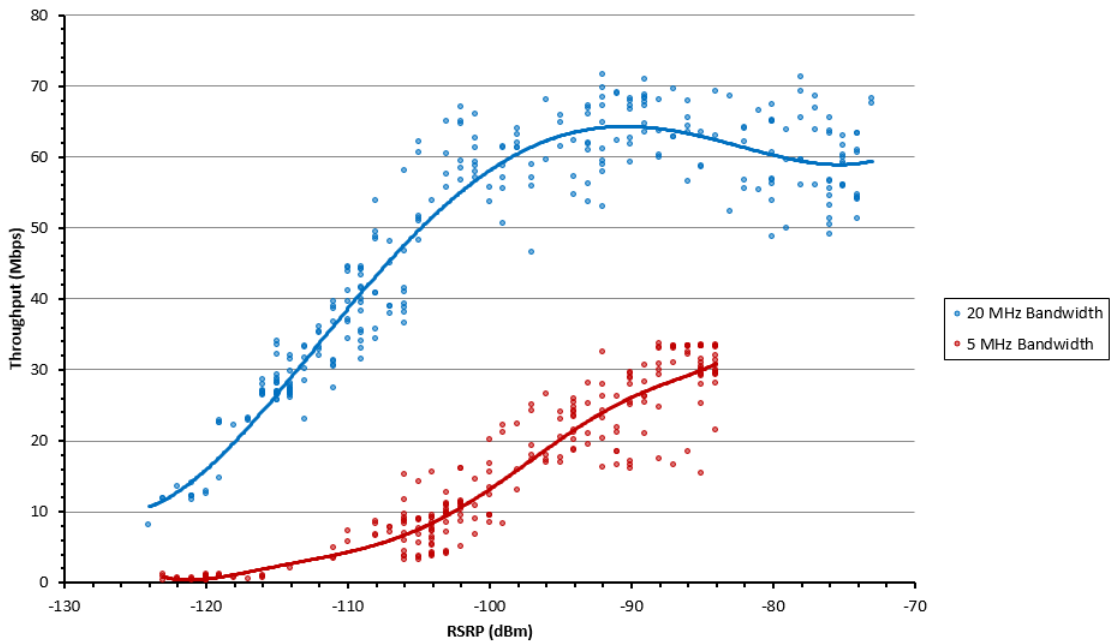

Figure 19: Throughput achieved on 5MHz and 20MHz bandwidths

Figure 19 confirms the initial assumption on throughputs: B38 with 20 MHz bandwidth provides in almost all situations a better throughput than B31 with



5 MHz bandwidth. Therefore B38 should be prioritized in most scenarios. Only exception is that when RSRP of B38 goes below -115 dBm, B31 could offer better throughput if it would be able to provide RSRP over -95 dBm in same geographical area. From figure 19 we can also deduct the lowest limit for acceptable service. By examining the scatter pattern, it could be determined that B31 is not able to provide suitable service when RSRP goes under -115 dBm, since after that achieved throughput is beneath acceptable. Same principal threshold should be applied to B38, even though decent level of throughput was achieved with RSRP values under -115 dBm. This decision was made because of the low TRS results on B38 obtained in OTA measurements. Additional measurements were conducted in order to find out relation between RSRQ and throughput, but the results of those measurements were too inconclusive and couldn't provide comparable data. This was mostly caused by the inadequate level of interference in laboratory environment.

Results of preliminary measurements corresponded with similar studies conducted on throughput capabilities of different bandwidths. For example, Haider et al. [33] have studied cell throughput capabilities between 10 MHz and 20 MHz bandwidths. Study was conducted between 800 MHz and 2600 MHz frequencies utilizing 10 MHz and 20 MHz bandwidths, respectively. During their study, Haider et al. found out that two times larger bandwidth was able to provide 50 % increase in throughput. Theoretically the difference in throughputs should be even larger, but the study concluded that greater path loss of higher frequency degraded the achieved throughput on 2600 MHz frequency.

Based on the chosen handover strategies and preliminary tests, a desirable handover functionality was determined. This functionality is described in figure 20, which illustrates a situation where UE moves between from B31 cell to B38 cell and back.

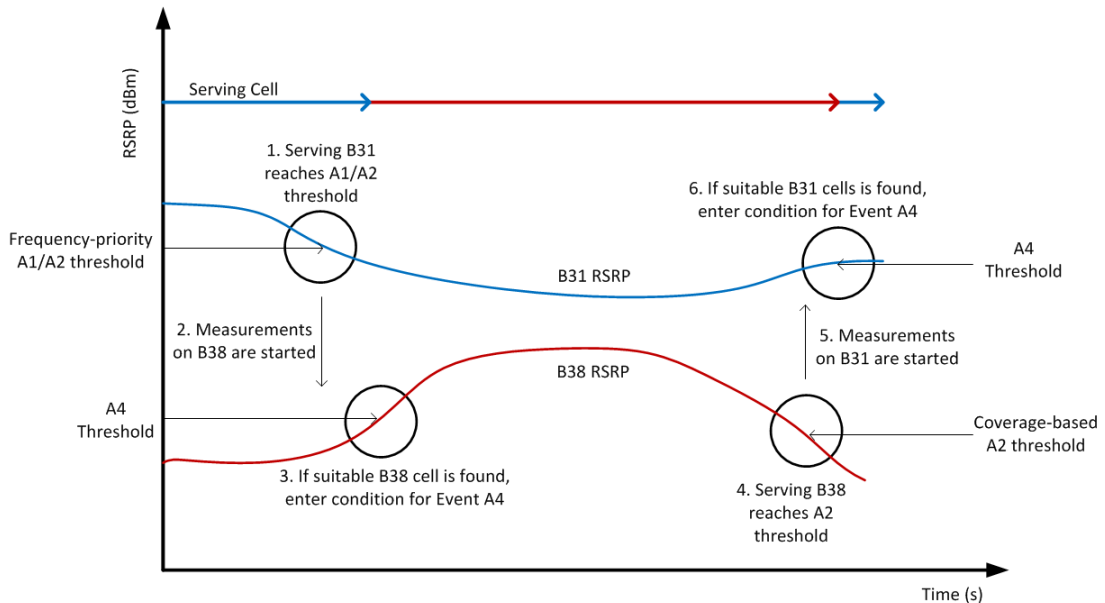

Figure 20: Desired handover functionality

Figure 20 describes a situation, where UE would travel within strong B31 cell. At some point, signal level of that cell would either drop under certain A2 threshold, or rise above certain A1 threshold, depending on present coverage-scenario. Figure 20 mainly emphasises a different-coverage situation, where the triggering event would be A2. Frequency-priority-based handover would be conducted on weaker B38 cell, but as seen in figure 19, UE would still most likely receive better service from that cell. After signal level of serving B38 cell reaches certain A2 threshold, coverage-based handover would be conducted in order to move the UE back to any available B31 cell. Discussed scenarios do not take into account a situation where UE establishes RRC connection inside B38 cell, since it does not fall in the scope of connected-mode mobility. Additionally, handovers can be conducted right after RRC connection has been established.

As the result of preliminary analysis, values represented in table 15 were chosen as handover parameters during the actual testing. Table 15 lists each key parameter, their default configuration values and values used with the modified handover scenario. In default scenario both cells utilize default values. Modified values are marked with green color.

Table 15: Studied configuration values

Parameter	Default value	Test value in B31 cell	Test value in B38 cell
A1A2 Measurement quantity	RSRP	RSRP	RSRP
A1A2 Hysteresis	1 dB	1 dB	3 dB
A1A2 TimeToTrigger	640 ms	640 ms	640 ms
A4 Measurement quantity	RSRP	RSRP	RSRP
A4 Hysteresis	1 dB	1 dB	1 dB
A4 TimeToTrigger	640 ms	640 ms	640 ms
Coverage-based measurements	Enabled	N/A	Enabled
Coverage-based handover event	Event A4	Event A4	Event A4
A1 RSRP Measurement threshold	-105 dBm	-	-112 dBm
A2 RSRP Measurement threshold	-109 dBm	-	-114 dBm
A4 RSRP Handover threshold	-105 dBm	-110 dBm	-105 dBm
Frequency-Priority measurements	Disabled	Enabled	Disabled
A1 RSRP Measurement threshold	-	-85 dBm	-
A2 RSRP Measurement threshold	-	-87 dBm	-

Following values were modified:

- **B38 A1A2 Hysteresis** was increased by 2 dB in order to prevent ping-pong effect between the cells. As seen from table 15, default A2 RSRP value for triggering coverage-based measurements is -109 dBm. In the modified scenario, handover from B31 to B38 can occur with B38 having seemingly low signal level of -110 dBm. It is important that new handover is not instantly triggered. This can be prevented by increasing the hysteresis value of coverage-based measurement enter condition  $M_s + Hys < Threshold$ .
- **B38 A1 and A2 Thresholds** were lowered in order to prolong handover measurement triggering. This way UE would stay connected to B38 cell for a longer time. As discussed before, -115 dBm was deemed as a lowest limit for reliable service, and therefore handover should be conducted at this point latest.
- **B31 A4 RSRP Threshold** was lowered in order to allow more likely handover to B38. Value of -110 dBm is 5 dBm higher than the limit of reliable service, which creates a buffer for signal level fluctuation.
- **B31 A1 and A2 RSRP Thresholds**, also functioning as frequency-priority measurement thresholds, were set only for measurements conducted on B38. As seen in figure 19, the provided throughput of B31 cell starts decreasing after signal level goes below -85 dBm. Therefore it would be advisable to conduct handover if suitable B38 cell is available.

Some of the values listed in table 15 were left unmodified. For example triggering quantities were left as defaults, since the available test environment was unsuitable for RSRQ based measurements. Additionally, TTT values were not modified since no justified reason for deviating from default values was found. Some other handover affecting values were also left as defaults. These values included:

- Frequency-specific offset (0 dB)
- Cell-specific offset (0 dB)
- Maximum number of reported cells (4)
- Amount of measurement reports sent (Infinite)
- Measurement report interval (240 ms)
- Measurement GAP pattern type (Type 1)
- L3 Filtering Coefficient (Filtering Coefficient 6)

Cell-specific or frequency-specific offsets were not modified for the studied scenario, since only two frequencies are used within the network. Therefore handover triggering can be managed solely with inter-frequency thresholds, since they are only applied between these two frequencies. If network included more different frequencies, threshold values would have to be more universal. In such case desired frequency specific triggering could be managed by utilizing frequency-specific or cell-specific offset values. Maximum number of reported cells, amount of measurement reports and measurement report interval values were considered suitable for a network with relatively large cells sizes. Larger number of reported cells would be

ideal in dense networks. From the listed values, measurement GAP pattern and L3 filtering coefficient values are recommended as potential values for further studies. By changing the GAP pattern type from type 1 to type 2, one could potentially gain better overall throughput for UEs at the expense of measurement accuracy. L3 filtering coefficient for one effects the weight that is given for earlier measurements when UE is calculating reportable values. These two latter values were not included within the scope of conducted tests, since they require relatively long testing period in order to determine their effect on network.

## 5 Performance evaluation

This chapter describes the conducted tests and measurements and gives an analysis considering achieved results. First section introduces the used test setup, while second section introduces actual measurements and their results. Finally, a brief analysis of results is given on third section.

### 5.1 Measurement setup

Measurement setup is illustrated in figure 21:

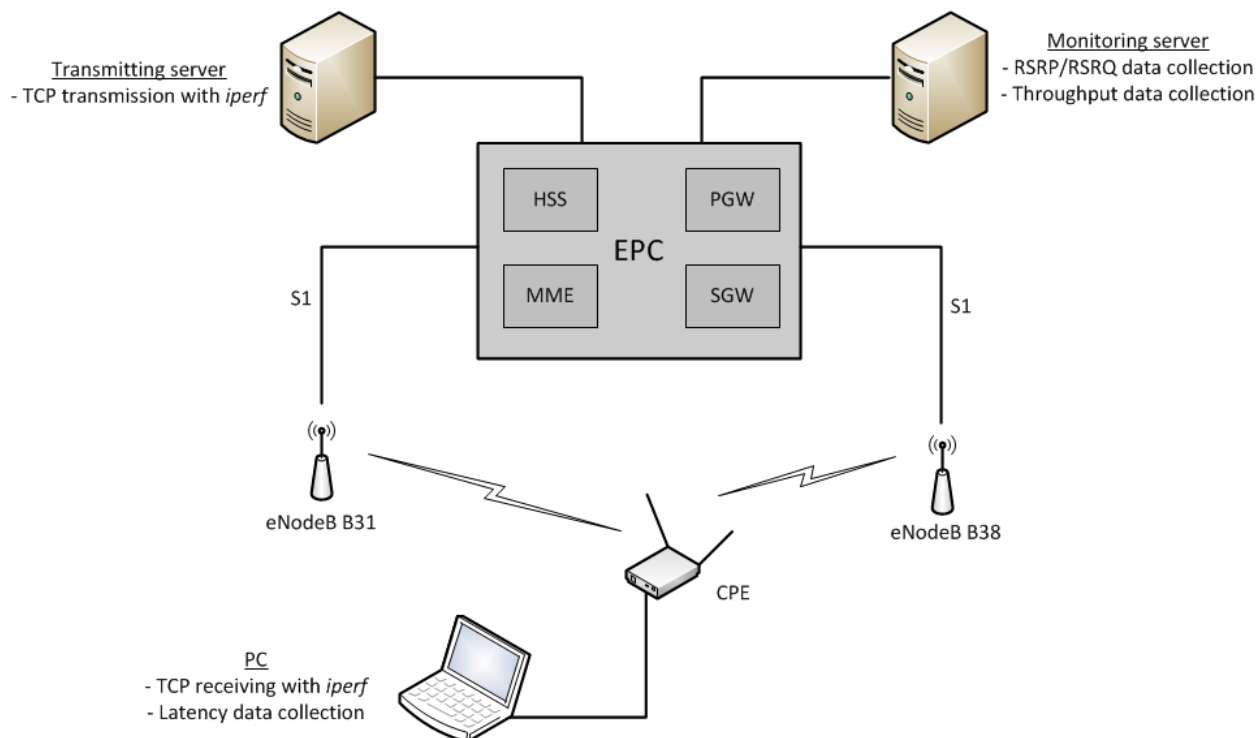

Figure 21: Test setup

Previously introduced Atel ALR-U276 LTE CPE was used within the actual measurements. During these measurements, CPE was also equipped with two external antennas, which both had a gain of 3 dB. CPE was then connected to a PC with ethernet cable, thus providing stable and fast medium between CPE and PC. Both CPE and PC were battery powered during testing in order to reduce interference caused by chargers. Test setup utilized two different eNodeBs, which used configurations described in table 16.

Table 16: eNodeB configurations used during measurements

Parameter	eNodeB B31	eNodeB B38
Number of cells	1	1
Bandwidth	5 MHz	20 MHz
Tx/Rx	2T2R	2T2R
Center frequency	465 MHz	2605 MHz
EARFCN	9895	38100
Subframe assingment	-	SA1 / SP7

Both eNodeBs were connected to same SGW, MME and PGW, and located within the same laboratory facility, meaning that there was no differentiation within transport network structure. Measurement data was collected from external measurement server, which collected user performance data directly from eNodeBs. In addition, separate traffic server was used to initiate continuous data streams towards the CPE. Data transmission was implemented as TCP transmission, which has been originally defined in RFC 793 [34]. TCP was chosen as transmission protocol, since it provides reliable transfer of data by applying acknowledge procedure on each packet. This acknowledge procedure ensures that no data is lost during transfer. Traffic server used *iperf* application to form five parallel TCP streams towards the CPE, which was enough to provide maximized data throughput CPE was capable of receiving. Tests were conducted only on downlink direction, since within telecommunications downlink often forms bottleneck for transmission. Users also tend to perceive downlink throughput as a limiting factor when analyzing service quality.

In chapter four, different measures for service quality were discussed. It was decided that within the scope of this thesis, service quality would be monitored by following three values: throughput, latency and signal quality of serving cell. Monitoring server was configured to capture data considering PRB utilization rate of both cells, together with RSRP and RSRQ of serving cell. Monitoring server also recorded downlink MAC layer throughput of both eNodeBs. PC was configured to capture latency related data with ICMP echo requests sent every second from the PC towards private loopback address located at one of core routers within the EPC. Both eNodeBs were limited to one user only, meaning that all available bandwidth resources were reserved for test purposes.

In order to capture desired handover related data, a measurement route between two different-coverage cells was created. Route began from close proximity of cell operating at B31, travelled near cell operating at B38, and ended up at the starting point. Test route covered both, handover from B31 to B38, and handover from B38 to B31. Total duration of the route was 360 seconds, and speed of the CPE remained constant during over the whole route.

## 5.2 Measurement results

### Measurements with default parameters

Measurements were first conducted with default handover parameters introduced in table 15. Purpose of default scenario measurements was to obtain data, which could be used to illustrate current situation of handover performance. In addition, this data would be used as reference data when determining whether proposed configuration changes made desired impact on network performance. Resulting graph is shown in figure 22, where passed time is shown in seconds on horizontal axis, while serving cell RSRP (dBm) and MAC layer throughput (Mbps) are shown on vertical axis. Similar notation is used in all graphs presented in this section. Graphs represent the average values calculated from all conducted measurements with same parameters. All measurements included between three and five separate takes to rule out random occurrences from resulting data.

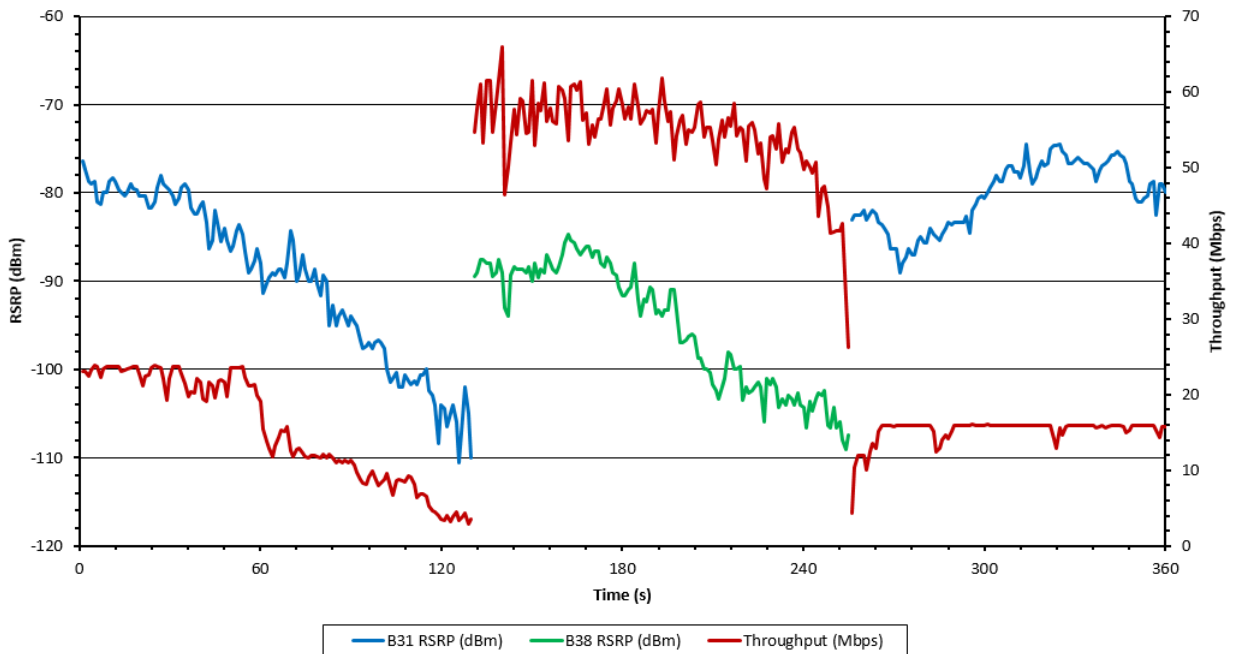

Figure 22: Measurements conducted with default configuration values

As seen in figure 22, UE is first attached to B31 cell with relatively good signal levels of -80 dBm and throughput value of 20 Mbps. When UE starts moving further away from the B31 eNodeB, signal level slowly deteriorates and eventually reaches -110 dBm. Simultaneously throughput has deteriorated at a same rate, and is only slightly over 3 Mbps just before first handover. Then at the mark of 130 seconds, handover is conducted to stronger B38 cell, which is able to provide RSRP of -90 dBm and throughput averaging on 60 Mbps. After 200 seconds UE starts moving away from the coverage of B38 cell, and at 256 seconds, handover to B31 cell is conducted. It is notable that while the signal level of B31 cell is seemingly better, it is still not able to provide better throughput than B38 cell was able before second

handover. Overall, throughput provided by B31 cell was not as good as it should have been, since after handover it could not reach values over 20 Mbps. This is most likely caused by a lower modulation scheme or missing MIMO transmission in one or two of the measurements. On average 234 seconds of the total duration was spent on B31 and 126 seconds on B38. Average throughput over 360 seconds was 28.91 Mbps with average RSRP of -88.9 dBm.

Figure 23 illustrates the average distribution of RSRQ values within measured on test route. High spread and uneven distribution caused a limitation to available test scenarios. Measured RSRQ values varied between -8 dB and -18 dB. RSRQ could not be tested as a handover triggering quantity within the provided test environment, since values used for RSRQ triggered handovers are between -8 dB and -12 dB.

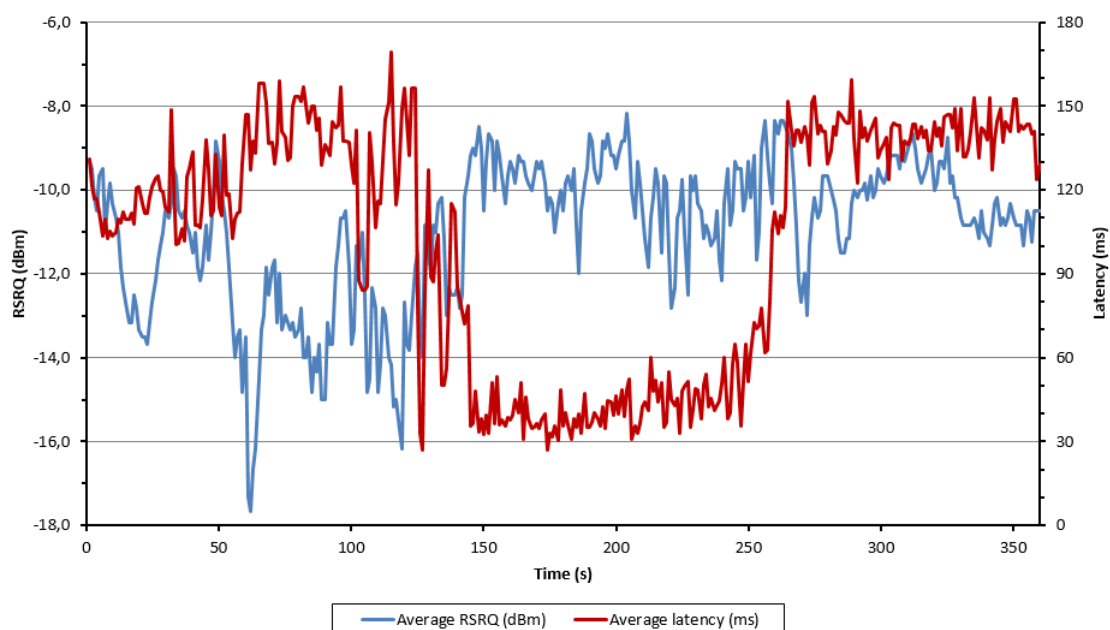

Figure 23: Relation of measured RSRQ and latency

Tests conducted with default configurations revealed that there was a great difference between achieved latency depending on serving cell. When UE was connected to B31 cell average latency was 133 ms, while B38 cell provided average latency of 44 ms. Average latency over the whole 360 seconds period was 102 ms. First assumption usually is that high latency is caused by a problem within transport connection, but since both eNodeBs were using identical transport mediums, this option was ruled out. Possibility of interference or low signal quality was also studied. However according to results, high latency occurred similarly on high and low RSRP and RSRQ values. This can be seen when comparing figures 22, 23 and 24.

Since ICMP tests were conducted simultaneously with TCP data transfers, high latency could be caused by limited resources within bandwidth resources. As 5 MHz bandwidth used by B31 cell is only capable of providing 25 PRBs, it causes a significant physical limitation to maximum available throughput within whole cell. From previously introduced table 10 we can read that FDD system providing 2T2R



downlink transmission is capable of providing theoretical maximum throughput of 50.4 Mbps. Therefore single UE can easily drain the capacity of whole cell. Figure 24 illustrates PRB usage of serving cell during the measurement period. Cell working on B31 is using all of the available resources during whole transmission period, which most likely explains high latency caused by congestion in radio transmission. 20 MHz B38 cell, which is able to provide 100 PRBs for each cell, utilized only 50 % of available PRBs. This means that the achieved maximum throughput of 60 Mbps is most likely related to physical limitations of either CPE or eNodeB.

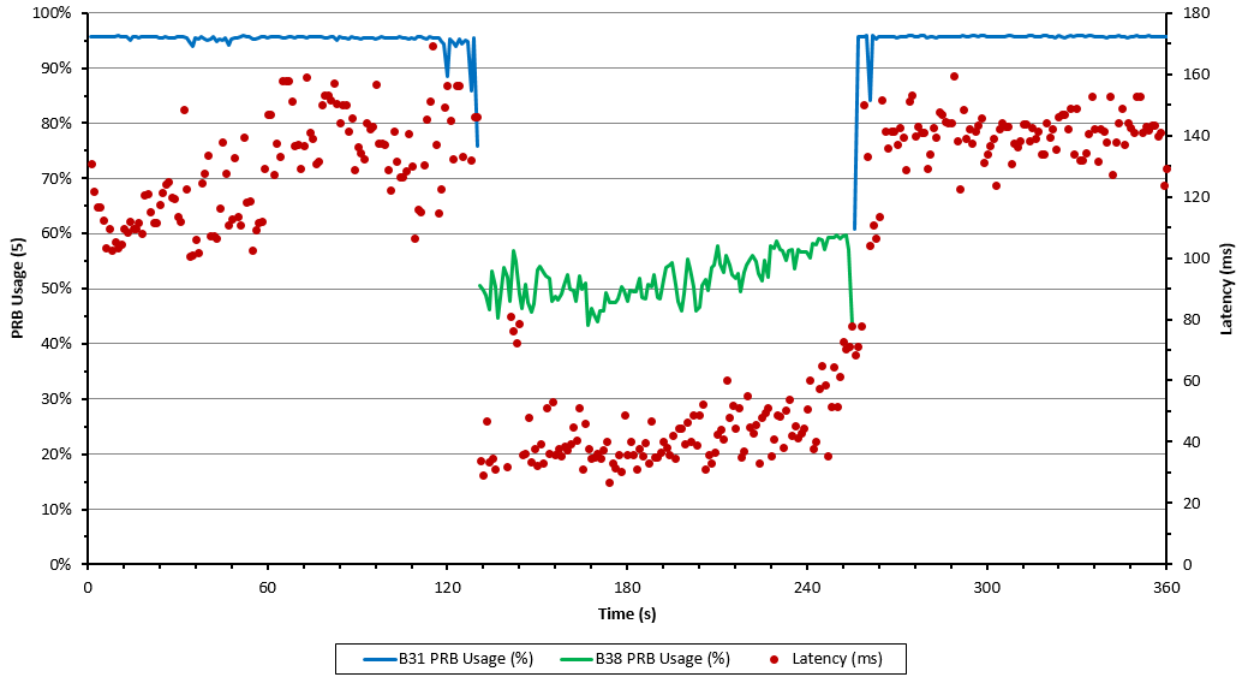

Figure 24: Relation of PRB Usage in a serving cell and latency

Since higher latency is most likely related to availability of bandwidth resources rather than to the aspects of individual frequency, no definite statements regarding superiority of either of bands can be made. However, since B38 is able to provide four times more transmission resources, it can be said that B38 is less likely to become congested. Since congestion causes reduction in perceived service quality, this issue further emphasizes the importance of load balancing by prioritizing B38 cells over B31. By introducing B38 with CA, transmission capability can be increased even further without additional physical installations.

### Measurements with modified parameters

Measurements were then conducted with modified handover parameters introduced in table 15. Average results from these measurements are illustrated in figure 25, which uses similar notation as figure describing results from default measurements.

Figure 25 shows that the modification of parameter values had a positive and desired effect on UEs behaviour. When compared to reference measurements, handover from B31 to B38 was conducted earlier at the 55 seconds mark. Similarly,

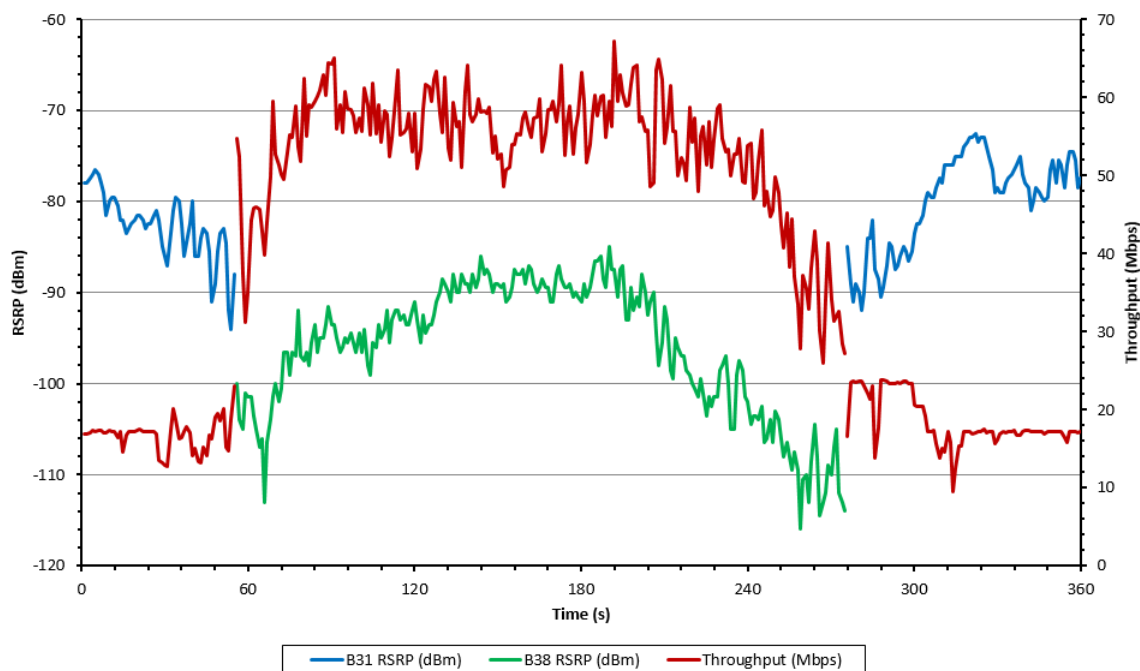

Figure 25: Measurements conducted with improved configuration values

handover from B38 to B31 was conducted after 276 seconds had passed. In total 221 seconds were spent on preferred B38, which is significantly more when compared to results from reference measurements. This caused an overall improvement to average throughput and average latency, but simultaneously reduced average RSRP over the route. Results are summarized in table 17.

Table 17: Measurement results

Value	Default configuration	Modified configuration	Change
Time on B31	234 sec	139 sec	- 41.6 %
Time on B38	126 sec	221 sec	+ 75.4 %
Average throughput	28.91 Mbps	39.50 Mbps	+ 36.6 %
Average latency	102 ms	84 ms	- 17.6 %
Average RSRP	-88.9 dBm	- 90.3 dBm	- 1.6 %

Most of the monitored values achieved positive changes when compared to reference measurements. Time spent on less efficient B31 cell was reduced by 41,6 %, and contrary time spent on B38 cell was increased by 75,4 %. Spending more time on cell with larger bandwidth resulted in 36,6 % increase in average throughput over the whole measurement period and 17,6 % decrease in average latency. Since throughput was valued over signal strength, optimization of handover parameters

resulted in 1,6 % reduction in average RSRP over the measurement period. However this can be considered a minor reduction when compared to gains achieved in throughput and latency.

### 5.3 Measurement analysis

Overall achieved results were positive and displayed desirable effect on network performance. Following figures represent the Cumulative Distribution Functions (CDF) of the measured results in both scenarios. Figure 26 compares the distribution of measured signal strengths between two scenarios. Since values on horizontal axis, which represents measured RSRP, grow when going towards right, graph that is located lower can be considered as the one having higher RSRP values throughout the measurement period. Both graphs are much alike, but slightly better results were obtained with default configurations. Default measurements had a larger amount of good RSRP values, whereas measurements with modified parameters collected a larger amount of lower RSRP values. This is most likely caused by more time spent on weaker B38 cell during latter measurements. However, as both graphs are mostly similar and follow similar trend, there is no clear indication which could point out reasons for not applying proposed changes to the network. Obtaining lower RSRP values in modified scenario was also known and anticipated effect, since handover threshold values were lowered in order to conduct handover earlier despite the fact that target cell would not be as strong as serving cell.

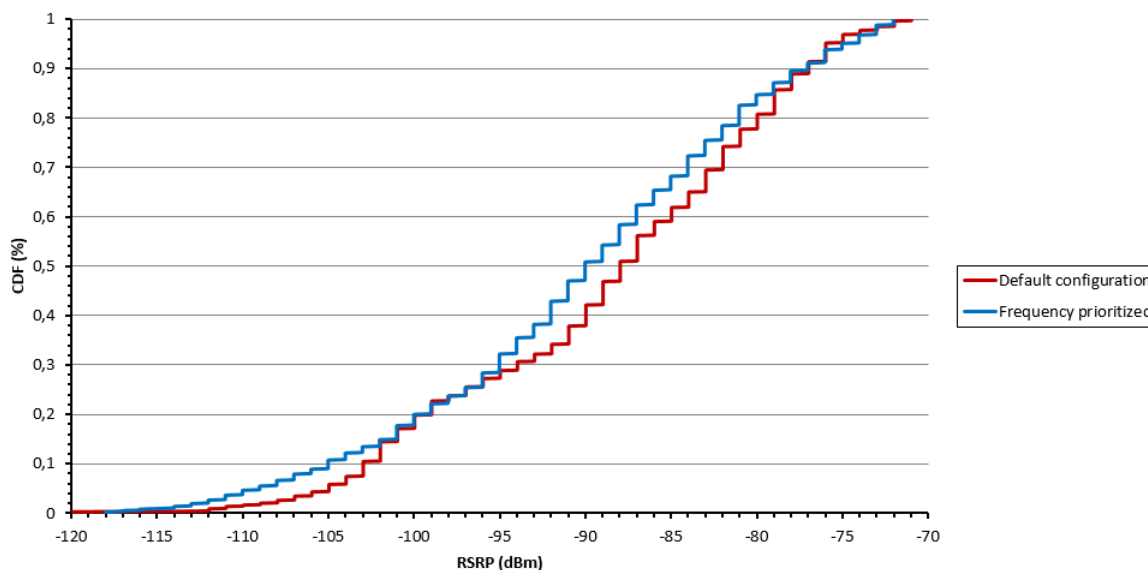

Figure 26: CDF representing distribution of RSRP

Figure 27 compares the distribution of throughput between both scenarios. Similarly to previous figure, higher throughput values are more desired, and therefore graph located lower tends to indicate better results. Previous graphs describing the RSRP distribution had quite a regular and continuously growing form, meaning

that most of the available values could be found within the measurement results, and the overall distribution of values was quite even. However, in figure 27 there exists some straight vertical lines creating irregularity within the graphs. Differences found within these lines indicate differences caused by parameter modification.

First of the straight vertical lines is seen at 12 Mbps mark at the default measurements and at 17 Mbps mark at latter measurements. Second vertical line is at 24 Mbps mark on both curves. It is likely that the first vertical line represents the consistent throughput measurement values that were acquired on B31 cell during both measurements. As discussed in previous section, some of the throughput measurements recorded in B31 cells capped to certain values. Therefore these first vertical lines can be left out of consideration. Second vertical lines however represent maximum throughput achievable in this particular B31 cell. Longer line seen in default measurements indicates that more time was spent within this capped environment. By reducing time on B31, this line became shorter, indicating that more higher values were measured during the measurement period.

It is also notable that the line representing default measurements in figure 27 crosses horizontal axis earlier than frequency-prioritized line. This indicates that values near zero were recorded during default measurements, while the smallest values within latter measurements were closer to 9 Mbps. Therefore measured throughput did not drop below 9 Mbps at any point of the measurement period.

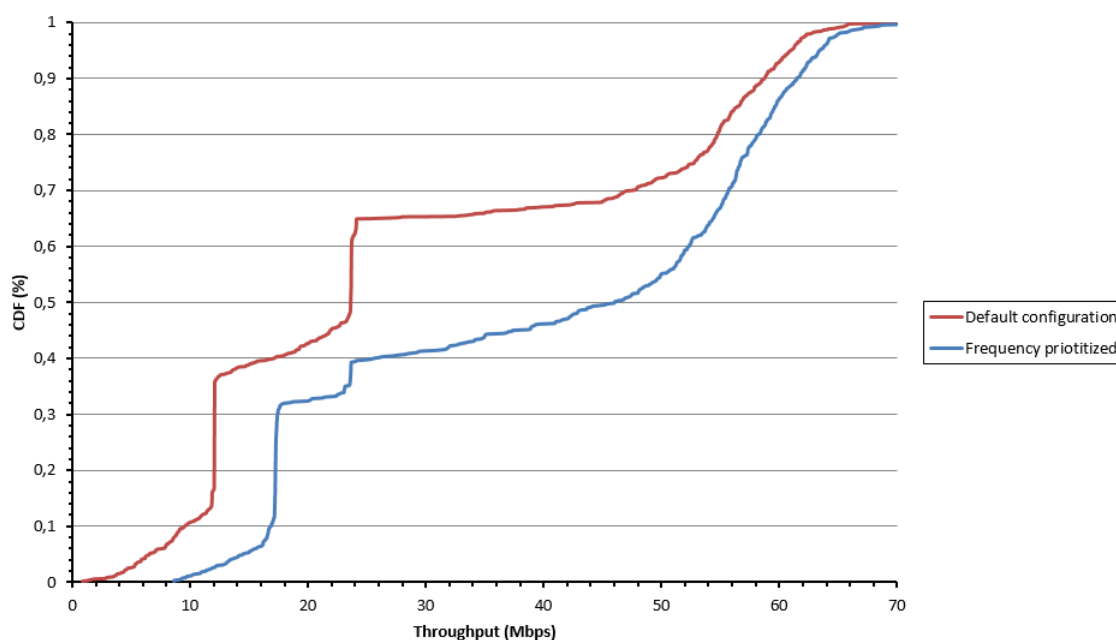

Figure 27: CDF representing distribution of throughput

Figure 28 compares the distribution of latency between two scenarios. Contrary to two previous figures, smaller horizontal values are preferred over larger values. Therefore, higher location of the line indicates that larger amount of small latency values were measured during measurement period. As discussed in previous section, bandwidth limited B31 cell is more likely to become congested from incoming traffic.

This means that multiple users, or one single but extremely active user, can populate whole available bandwidth. Therefore spending less time on B31 cell improved the overall latency during measurements conducted with modified parameters. Similarly to previous figure, vertical climbs on the lines indicate that multiple values from the point of climb were measured. During default measurements, many of the measured latency values were either 40, 110 or 140 ms. When comparing these values with latency values presented earlier in figure 24, it can be determined that latency values around 40 ms were measured from B38 cell, while larger values were all measured from B31 cell. Line representing modified measurements does not have similar vertical climbs during high latency values. From the graph we can interpret that during the measurements conducted with modified parameters, over 50 % of measured latency values were less than 65 ms. On contrary, in default measurements same 50 % mark is crossed at 115 ms.

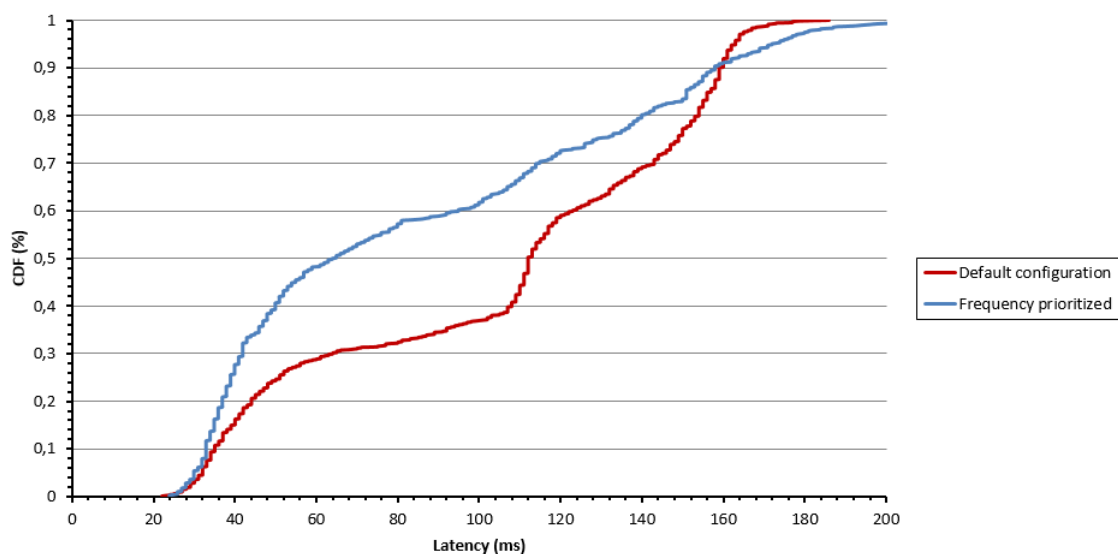

Figure 28: CDF representing distribution of latency

## 6 Conclusions

### 6.1 Obtained results

Preliminary measurements and previous studies indicated that since cells operating with wider bandwidth are able to provide higher transmission capacity, band 38 should be used as the primary source of transmission whenever available. Since default handover configuration of the studied network accounts only for signal strength of serving cell, and ignores cells other capabilities, a clear need for change was noted. Measurements conducted with default network handover configurations confirmed that UEs tend to spend too much time on less capable B31 cells. Preliminary analysis was conducted in order to define level of agreeable service and achievable throughput values. Obtained preliminary results were used to define desired handover parameters. In order to emphasize handover from B31 to B38, inter-frequency measurement thresholds were raised and handover decision thresholds were lowered for UEs connected to B31 cells. Opposite actions were taken on UEs connected to B38 cells to prolong UEs stay on preferred cell. Additionally, hysteresis of B38 cells was raised in order to minimize ping-pong effect occurring in overlapping cells. With the modified handover threshold values, time spent on B31 was successfully reduced and spent on B38 instead. This resulted in improved throughput over the measured route and in a slight decrease in average serving cell RSRP. However, the decrease in RSRP was relatively minor when compared with the gains in throughput, meaning that positive outcomes outweighed negative ones.

### 6.2 Assessment of results

Results demonstrated that by modifying handover related key parameters, some aspects of user-perceived service quality can be enhanced. Conducted performance analysis was based mainly on achievable throughput, which might not be the primary source of perceived value for all affected users. Network operator has to carefully analyse whether the proposed changes are beneficial for all users. By widening the scope of this thesis, and increasing the number of followed metrics, achieved results would become more useful. If additional measurement metrics are used, results obtained within this thesis should be re-evaluated accordingly. Results were consistent with previous studies, which increases the reliability of conducted tests. All measurements included several takes in order to reduce measurement errors and inconsistencies within the collected data. However, some irregularities were noticed in terms of achieved modulation in B31 cells. This caused slight drop in measured throughput, which decreases the overall reliability of the chosen test method. Conducted tests are highly equipment dependable, but repeatable if similar laboratory setup is used. It is likely that with different kind of equipment setup, different kind of results would be achieved. This is mostly caused by varying transmission capabilities of radio transmitters and end-user equipments. All desired features, including RSRQ as a triggering quantity, could not be studied within the scope of this thesis. This means that even further improvements could be made by improving and scaling

up the test environment. Obtained results provide a clear and generalized view on how proper handover strategy effects service performance. It is recommended that achieved results are studied and, if applicable, implemented to the network.

### 6.3 Applicability of results

Achieved results are applicable mostly to the studied LTE-network. Measurements were conducted in laboratory environment utilizing same devices and network elements which are used within the live network. Chosen CPE model is widely distributed among customers, and is used daily by multiple mobile subscribers. Similar measurements conducted with different CPE models may obtain different results according to CPEs capabilities. Used base station equipment was identical to equipment deployed in the live network, with exceptions in utilized antennas and their installation heights. Therefore obtained results could be applied to the live network after some additional drive testing. However, as measurements were conducted in laboratory environment, some limitations do apply. For example fading characteristics are highly different in laboratory environment when compared to outside environments. Shorter distances used in laboratory require installation of additional attenuators in order to guarantee safe working environment. This causes slight deform to obtained results.

### 6.4 Future research

For future needs, more thorough measurements in live network should be conducted. Laboratory testing gives a reasonable assumption on how different features and network functions behave, but still lack the feasibility required for implementing solutions to larger environments. Separate drive testing should be conducted throughout the whole network area, and longer time period for monitoring individual KPIs is recommended. In addition, user feedback should be collected from selected mobile users. From the available handover strategies, more research should be conducted regarding uplink-quality-based handover strategy. Especially when operating with narrow bandwidths, uplink can often be reducing factor in terms of overall service quality. Therefore handover triggers should not depend solely on downlink measurements, as they do in most default configurations introduced by device manufacturers. Available testing environment was unsuitable for testing out RSRQ as handover triggering quantity for inter-frequency handovers. As described in chapter four, many studies have found out that handover solutions based solely on RSRP are not able to provide optimal solution for heterogeneous network structures. Therefore it is highly recommended that RSRQ as a handover trigger should be studied and, if applicable, implemented to the live network. Handover is considered only a single part of whole mobility. When discussing service quality perception in wider scope, research should be extended to cover idle-mode mobility and cell re-selection. Current handover model only takes into account users operating in connected mode, which leaves idle users outside load balancing activities.

## References

- [1] Tara Ali-Yahiya. *Understanding LTE and its Performance*. Springer Science & Business Media, 2011.
- [2] Christopher Cox. *An introduction to LTE: LTE, LTE-advanced, SAE and 4G mobile communications*. John Wiley & Sons, 2012.
- [3] Harri Holma and Antti Toskala. *LTE for UMTS: Evolution to LTE-advanced*. John Wiley & Sons, 2011.
- [4] 3GPP. Evolved Universal Terrestrial Radio Access (E-UTRA); User Equipment (UE) radio access capabilities. TS 36.306, 3rd Generation Partnership Project (3GPP), April 2016.
- [5] Ralf Kreher and Karsten Gaenger. *LTE signaling: troubleshooting and optimization*. John Wiley & Sons, 2010.
- [6] Aderemi A Atayero, Matthew K Luka, Martha K Orya, and Juliet O Iruemi. 3GPP Long Term Evolution: Architecture, protocols and interfaces. *International Journal of Information and Communication Technology Research*, 1(7):306–310, 2011.
- [7] 3GPP. General Packet Radio Service (GPRS) enhancements for Evolved Universal Terrestrial Radio Access Network (E-UTRAN) access. TS 23.401, 3rd Generation Partnership Project (3GPP), March 2016.
- [8] Erik Dahlman, Stefan Parkvall, and Johan Skold. *4G: LTE/LTE-advanced for mobile broadband*. Academic press, 2013.
- [9] Angel Ivanov. TD-LTE and FDD-LTE, A Basic Comparison. TS NT10-00185, ASCOM, November 2010.
- [10] Qualcomm. FDD/TDD Comparison Key Messages. Technical report, Qualcomm, July 2013.
- [11] 3GPP. Evolved Universal Terrestrial Radio Access (E-UTRA); Long Term Evolution (LTE) physical layer; General description. TS 36.201, 3rd Generation Partnership Project (3GPP), March 2016.
- [12] 3GPP. Evolved Universal Terrestrial Radio Access (E-UTRA); Physical channels and modulation. TS 36.211, 3rd Generation Partnership Project (3GPP), March 2016.
- [13] 3GPP. Evolved Universal Terrestrial Radio Access (E-UTRA); Physical layer - Measurements. TS 36.214, 3rd Generation Partnership Project (3GPP), March 2016.



- [14] 3GPP. Evolved Universal Terrestrial Radio Access (E-UTRA); Requirements for support of radio resource management. TS 36.133, 3rd Generation Partnership Project (3GPP), April 2016.
- [15] Ayman ElNashar, Mohamed El-saidny, and Mahmoud Sherif. *Design, deployment and performance of 4G-LTE networks: A practical approach*. John Wiley & Sons, 2014.
- [16] 3GPP. Evolved Universal Terrestrial Radio Access (E-UTRA); User Equipment (UE) procedures in idle mode. TS 36.304, 3rd Generation Partnership Project (3GPP), March 2016.
- [17] 3GPP. Evolved Universal Terrestrial Radio Access (E-UTRA) and Evolved Universal Terrestrial Radio Access Network (E-UTRAN); Overall description; Stage 2. TS 36.300, 3rd Generation Partnership Project (3GPP), April 2016.
- [18] 3GPP. Non-Access-Stratum (NAS) functions related to Mobile Station (MS) in idle mode. TS 23.122, 3rd Generation Partnership Project (3GPP), April 2016.
- [19] 3GPP. Evolved Universal Terrestrial Radio Access (E-UTRA); Radio Resource Control (RRC); Protocol specification. TS 36.331, 3rd Generation Partnership Project (3GPP), April 2016.
- [20] Aamod Khandekar, Naga Bhushan, Ji Tingfang, and Vieri Vanghi. LTE-Advanced: Heterogeneous networks. In *Wireless Conference (EW), 2010 European*, pages 978–982. IEEE, 2010.
- [21] Aleksandar Damnjanovic, Juan Montojo, Yongbin Wei, Tingfang Ji, Tao Luo, Madhavan Vajapeyam, Taesang Yoo, Osok Song, and Durga Malladi. A survey on 3GPP heterogeneous networks. *IEEE Wireless Communications*, 18(3):10–21, 2011.
- [22] 3GPP. Evolved Universal Terrestrial Radio Access (E-UTRA); User Equipment (UE) radio transmission and reception. TS 36.101, 3rd Generation Partnership Project (3GPP), March 2016.
- [23] Johnson Chris. *Long Term Evolution in bullets*. CreateSpace Independent Publishing Platform, 2012.
- [24] IEEE standard for definitions of terms for antennas. *IEEE Standard 145-2013 (Revision of IEEE Standard 145-1993)*, pages 1–50, 2014.
- [25] Masaharu Hata. Empirical formula for propagation loss in land mobile radio services. *IEEE transactions on Vehicular Technology*, 29(3):317–325, 1980.
- [26] COST. 231, “Digital mobile radio towards future generation systems. Technical report, final report,” tech. rep., European Communities, EUR 18957, 1999.

- [27] Muhammad Kazmi, Olof Sjobergh, Walter Muller, Jonas Wierok, and Bengt Lindoff. Evaluation of inter-frequency quality handover criteria in E-UTRAN. In *Vehicular Technology Conference, 2009. VTC Spring 2009. IEEE 69th*, pages 1–5. IEEE, 2009.
- [28] Ionel Petrut, Marius Ottesteanu, Cornel Balint, and Georgeta Budura. HetNet handover performance analysis based on RSRP vs. RSRQ triggers. In *Telecommunications and Signal Processing (TSP), 2015 38th International Conference on*, pages 232–235. IEEE, 2015.
- [29] Mahima Mehta, Nadeem Akhtar, and Abhay Karandikar. Impact of handover parameters on mobility performance in LTE HetNets. In *Twenty First National Conference on Communications (NCC)*, pages 1–6. IEEE, 2015.
- [30] Verkotan. OTA Test Report. Technical report, Verkotan Oy, Finland, April 2016.
- [31] 3GPP. Measurements of User Equipment (UE) radio performances for LTE/UMTS terminals; Total Radiated Power (TRP) and Total Radiated Sensitivity (TRS) test methodology. TS 37.902, 3rd Generation Partnership Project (3GPP), January 2016.
- [32] 3GPP. Measurements of radio performances for UMTS terminals in speech mode. TS 25.914, 3rd Generation Partnership Project (3GPP), January 2016.
- [33] Fourat Haider, Erol Hepsaydir, and Nicola Binucci. Performance analysis of LTE-advanced networks in different spectrum bands. In *Wireless Advanced (WiAd), 2011*, pages 230–234. IEEE, 2011.
- [34] J. Postel. Transmission Control Protocol. RFC 793 (Internet Standard), September 1981. Updated by RFCs 1122, 3168, 6093, 6528.