This is an electronic reprint of the original article.
This reprint may differ from the original in pagination and typographic detail.

Author(s): Zakharov, Alexey & Yu, Miao & Jamsa-Jounela, Sirkka-Liisa
Title: A dynamic prognosis algorithm in distributed fault tolerant model predictive control
Year: 2014
Version: Post print

Please cite the original version:

Zakharov, Alexey & Yu, Miao & Jamsa-Jounela, Sirkka-Liisa. 2014. A dynamic prognosis algorithm in distributed fault tolerant model predictive control. 1238 - 1243. DOI: 10.1109/cca.2014.6981498.

Rights: © 2014 Institute of Electrical & Electronics Engineers (IEEE). Permission from IEEE must be obtained for all other uses, in any current or future media, including reprinting/republishing this material for advertising or promotional purposes, creating new collective works, for resale or redistribution to servers or lists, or reuse of any copyrighted component of this work in other work.

All material supplied via Aaltodoc is protected by copyright and other intellectual property rights, and duplication or sale of all or part of any of the repository collections is not permitted, except that material may be duplicated by you for your research use or educational purposes in electronic or print form. You must obtain permission for any other use. Electronic or print copies may not be offered, whether for sale or otherwise to anyone who is not an authorised user.

A dynamic prognosis algorithm in distributed fault tolerant model predictive control

Alexey Zakharov, Miao Yu, Sirkka-Liisa Jämsä-Jounela

Abstract—This paper presents a dynamic prognosis algorithm in distributed fault tolerant model predictive control (DFTMPC). The dynamic prognosis, which means predicting the trajectories of process variables under distributed model predictive control, is performed when a fault is diagnosed and several candidate reconfigured controls are proposed. Then, the dynamic prognosis is utilized to check whether the candidate reconfigured controls are able to drive the system to the new operating conditions and to evaluate the performance during the transition period. Thus, the most suitable candidate reconfigured controller is selected and its feasibility is ensured without using a Lyapunov function that is difficult to obtain for large-scale systems. On the other hand, the on-line computation burden of the prognosis algorithm is moderate under the assumption that the sets of active constraints in non-faulty subsystems remain the same as they are at the nominal operating conditions. Thus, the dynamic prognosis for DMPC is aimed to improve the applicability of the existing fault tolerant methods to large-scale systems.

Index Terms—fault tolerant control, distributed model predictive control, dynamic prognosis, alkylation of benzene, industrial application.

I. INTRODUCTION

Increased global competition, higher product quality requirements, and environmental regulations have forced the process industry to continuously optimize the efficiency and profitability. Advanced control strategies, such as model predictive control (MPC), have made it possible to run the processes close to the quality and safety limits thereby increasing profitability, ensuring the better quality of the end products, and enhancing safety in the plants [1], [2]. Furthermore, advanced management of abnormal situations, such as process disturbances and faults, still provides great possibilities for further improvement of the process efficiency [3] [4] [5].

Recently, fault tolerant model predictive control (FTMPC), providing flexibility in compensating for the fault effects by considering the problem at least at the process unit level, was extensively studied [6]. The corrective actions of FTC can be categorized into fault accommodation and controller reconfiguration techniques. In our previous works [7] and [8], a fault accommodation based FTMPC was proposed and tested in a complex dearomatization process. Despite being an attractive approach, fault accommodation is infeasible in many cases, especially when control capacity degrades because of an actuator fault. Thus, control reconfiguration

approach was proposed, aiming to replace the “dropped out” actuator using redundant control capacity. For example, [9] developed two alternative SISO controls of a polyethylene reactor manipulating different actuators: the temperature of a feed flow and a catalyst flow rate. In case of an actuator failure, the control relying on the healthy actuator was applied. Alternatively, [10] considered two actuator faults and developed two back-up controls which were applied when the respective fault was discovered. However, it is difficult or impossible to develop back-up control strategies for all possible faults in large-scale systems. That is why it is important to provide the possibility to generate reconfigured control and evaluate its performance on-line.

The first issue a FTC has to deal with on-line is the selection of the plant operating point. The nominal process operating conditions can sometimes become infeasible because of a fault, and in such a case, a new operating point must be defined. Thus, [10] proposed the use of the feasible steady state closest to the nominal steady state of the system as the new target operating points. [11] proposed the selection of new operating points of the faulty unit in a way that the downstream units could continue operating at the nominal process conditions and this was implemented as additional constraints imposed on the new operating points of the faulty systems.

Another major issue is to ensure the plant stability under a reconfigured control on-line while selecting among the candidate reconfigurations. [9] determined the stability regions of the alternative controls when an actuator fault occurs, and [10] utilized a modification of MPC to ensure its stability. Even though both approaches were able to safeguard the stability, a suitable Lyapunov function must be developed in both methods, which makes them difficult or even impossible to use in case of large-scale systems. Recently, [12] suggested a safe-parking approach which selects new operating points from the feasible steady states of the system which can be achieved by the reconfigured control without destabilizing the system. As a result, the operating point at the moment of fault diagnosis, which is typically close to the nominal steady state, must belong to the stability region of the reconfigured control that is developed to operate at new process conditions. The drawback is that this makes the stability properties even more difficult to obtain. Therefore, there is a clear demand for easier solutions to evaluate the possible control reconfigurations and to select one of them.

As most of the FTC systems in the literature were based on a centralized MPC for the whole process, there have been only a few attempts to establish FTC strategy based on

The authors are with Aalto University, School of Chemical Technology, Department of Biotechnology and Chemical Technology, 00076 Aalto, Finland. Email: alexey.zakharov {miao.yu, sirkka-liisa.jamsa-jounela}@aalto.fi.

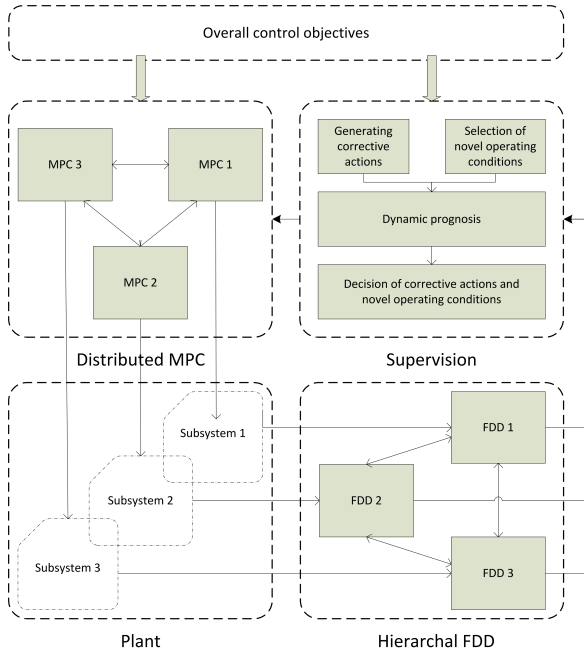

Fig. 1. Outline of DFTMPC

DMPC for complex industrial systems until now [11] [13] [14]. In order to bridge the gap between FTC and DMPC for large-scale systems, a general idea for the design of a distributed fault tolerant model predictive control (DFTMPC) strategy is presented. The key element of the DFTMPC is the dynamic prognosis, which predicts the process variables trajectories under the assumption that reconfigured controls and new setpoints are proposed. The aim of this step is to check whether the reconfigured control could drive the process to the new operating conditions and to evaluate its dynamic performance during the transition. Thus, the most suitable one among the candidate reconfigured controllers is found.

II. OUTLINE OF THE DFTMPC

The DFTMPC for large-scale systems mainly includes the following five elements: DMPC, hierarchical FDD, determination of possible new operating conditions of the faulty unit and generation of possible reconfigured controllers, dynamic prognosis, and selection of corrective actions. The overall structure of DFTMPC is shown in Figure 1.

A large-scale system can be decomposed into different unit processes according to the process topology, which provides a foundation for both FDD methods [15] and DMPC [16].

After the fault has been diagnosed, we need to define the new operating conditions of the system according to the control objectives with the fault information provided by the FDD element. The new operating conditions of the whole system can be selected from the set of steady states of the system under faulty dynamics. As an additional constraint, the target operating conditions in the downstream units must be disturbed as little as possible [11]. A group of candidate setpoints can be found by applying different

selection criteria, such as minimizing the distance from the current process state, maximizing the economic efficiency of the faulty process unit, and minimizing the production rate degradation, etc.

The possible reconfigured controls are generated to achieve the control aims in presence of the faults. For example, in the case of an actuator fault (such as actuator freezing), the faulty actuator is usually excluded from the control structure. The reconfiguration also means that alternative actuators can be included instead to compensate for the excluded actuator, or some actuator constraints are modified, for instance, according to degradation of a faulty actuator capacity. Thus, several reconfigured control structures can be generated for further evaluation.

The dynamic prognosis is the key step in selecting the most suitable corrective actions. Namely, the ability of the candidate reconfigured controllers to drive the process to the proposed new operating conditions is checked. Next, the trajectories of the process variables are studied to evaluate the control quality during the transition period. The dynamic prognosis for a DMPC essentially relies on the assumption that the active constraints in the non-faulty subsystems remain the same as they are in the nominal conditions. This assumption allows considering the optimization of the only MPC relating to the faulty subsystem, and then, the rest of the controls in non-faulty subsystems are obtained explicitly. In the result, the on-line computation burden of the prognosis algorithm is not heavy and the decision can be achieved early before the system state is driven away from the nominal operating conditions. Finally, one of the suitable reconfigured controls can be selected by some indexes, such as minimizing the IAE between the predicted trajectories of process variables and their setpoints.

III. DYNAMIC PROGNOSIS ALGORITHM

In this section, the dynamic prognosis is developed to predict the process variables trajectories in both non-faulty and faulty subsystems. Assuming the active constraints in the non-faulty subsystems remain the same as they were in the nominal operating conditions, the manipulated variables related to the non-faulty subsystems can be expressed as linear functions of the current plant state, the manipulated variables related to the faulty subsystem, and the setpoints. Thus, the decision variables of the DMPC optimization can be reduced to the variables belonging to the faulty subsystem only.

The following notations are used: capital letters stand for matrices whereas the bold symbols denote the vectors including components related to the future time instants.

The system dynamics of post-faulty processes are obtained with FDD information as follows

$$\begin{aligned} x(k+1) &= Ax(k) + Bu(k), \\ y(k) &= Cx(k), \end{aligned} \quad (1)$$

where the input u , output y and states x can be decomposed as follows according to the modular process structure: $x(k) = [x_1^T(k), x_2^T(k), \dots, x_N^T(k)]^T$, $u(k) = [u_1^T(k), u_2^T(k), \dots, u_N^T(k)]^T$,

$y(k) = [y_1^T(k), y_2^T(k), \dots, y_N^T(k)]^T$, and the dynamics matrices possess the appropriate block structure:

$$\begin{aligned} A &= \begin{bmatrix} A_{11} & A_{12} & \dots & A_{1N} \\ A_{21} & A_{22} & \dots & A_{2N} \\ \dots & \dots & \dots & \dots \\ A_{N1} & A_{N2} & \dots & A_{NN} \end{bmatrix}, \\ B &= [B_1 | B_2 | \dots | B_N], \\ C &= [C_1^T, C_2^T, \dots, C_N^T]^T, \end{aligned}$$

where A , B , and C are with appropriate dimensions.

The future trajectory of the outputs of subsystem i can be obtained using the Toeplitz matrices as $\mathbf{y}_i = \sum_{j=1}^N \mathbf{T}_{ij} \mathbf{u}_j + \mathbf{V}_i x^0$, where $\mathbf{y}_i = [y_i^T(1), y_i^T(2), \dots, y_i^T(P)]^T$, $\mathbf{u}_i = [u_i^T(0), u_i^T(1), \dots, u_i^T(P-1)]^T$, P is the prediction horizon of each local MPC, x^0 is the initial state of the system, and the Toeplitz matrices are defined as

$$\begin{aligned} \mathbf{T}_{ij} &= \begin{bmatrix} C_i B_j & 0 & \dots & 0 \\ C_i A B_j & C_i B_j & \dots & 0 \\ \dots & \dots & \dots & \dots \\ C_i A^{P-1} B_j & C_i A^{P-2} B_j & \dots & C_i B_j \end{bmatrix}, \\ \mathbf{V}_i &= [(C_i A)^T, (C_i A^2)^T, \dots, (C_i A^P)^T]^T. \end{aligned}$$

Furthermore, consider the individual MPC formulation for i -th subsystem with a quadratic objective as

$$\begin{aligned} \Phi_i(u) &= \sum_{k=1}^P (y_i(k) - s_i)' Q_i (y_i(k) - s_i) + u_i'(k) R_i u_i(k) \\ &= (\mathbf{y}_i - \mathbf{s}_i)' \mathbf{Q}_i (\mathbf{y}_i - \mathbf{s}_i) + \mathbf{u}_i' \mathbf{R}_i \mathbf{u}_i \end{aligned} \quad (2)$$

where s_i denote the vector containing the setpoints for subsystem i , $\mathbf{s}_i = [s_i, \dots, s_i]^T$, matrices Q_i and R_i represent the MPC objective weights, $\mathbf{Q}_i = \text{diag}\{Q_i\}$ and $\mathbf{R}_i = \text{diag}\{R_i\}$. The linear constraints for i -th subsystem within the prediction horizon are described as

$$c_i(\mathbf{u}, x^0) = \mathbf{G}_i \mathbf{u} + \mathbf{G}_i^x x^0 + \mathbf{g}_i \geq 0, \quad (3)$$

where \mathbf{G}_i and \mathbf{G}_i^x are some matrices related to input and state respectively.

Denote i to be the index of the subsystem in which a fault is found. Assume that the active constraints of the local MPCs in other non-faulty subsystems will stay the same, as it was at the nominal operating conditions. Denote $\tilde{\mathbf{G}}_j$ and $\tilde{\mathbf{g}}_j$ to represent the matrices associated with the active constraints in the non-faulty subsystems j ,

$$\tilde{\mathbf{G}}_j^x x^0 + \tilde{\mathbf{G}}_j^i \mathbf{u}_i + \tilde{\mathbf{G}}_j \mathbf{u}_j + \tilde{\mathbf{g}}_j = 0, \quad \forall j \neq i, \quad (4)$$

and assemble the constraints matrices as: $\tilde{\mathbf{G}}^x = [(\tilde{\mathbf{G}}_1^x)^T, \dots, (\tilde{\mathbf{G}}_{i-1}^x)^T, (\tilde{\mathbf{G}}_{i+1}^x)^T, \dots, (\tilde{\mathbf{G}}_N^x)^T]^T$, $\tilde{\mathbf{G}}^i = [(\tilde{\mathbf{G}}_1^i)^T, \dots, (\tilde{\mathbf{G}}_{i-1}^i)^T, (\tilde{\mathbf{G}}_{i+1}^i)^T, \dots, (\tilde{\mathbf{G}}_N^i)^T]^T$, $\tilde{\mathbf{G}} = [(\tilde{\mathbf{G}}_1)^T, \dots, (\tilde{\mathbf{G}}_{i-1})^T, (\tilde{\mathbf{G}}_{i+1})^T, \dots, (\tilde{\mathbf{G}}_N)^T]^T$, and $\tilde{\mathbf{g}} = [(\tilde{\mathbf{g}}_1)^T, \dots, (\tilde{\mathbf{g}}_{i-1})^T, (\tilde{\mathbf{g}}_{i+1})^T, \dots, (\tilde{\mathbf{g}}_N)^T]^T$. The values of the manipulated variables \mathbf{u}_i^c relating to the subsystems other than i , i.e. $\mathbf{u}_i^c = [(u_i^c)^T(0), \dots, (u_i^c)^T(P-1)]^T$, where $u_i^c(k) = [u_1^T(k), \dots, u_{i-1}^T(k), 0, u_{i+1}^T(k), \dots, u_N^T(k)]^T$, can be obtained by minimizing the objective function (2) under constraints

(4), whereas the inputs \mathbf{u}_i representing the faulty subsystem i and the initial system state x^0 are fixed. Substituting system dynamics into (2), \mathbf{u}_i^c can be obtained by minimizing the following objective function

$$\begin{aligned} &\sum_{j=1}^N (\mathbf{V}_j x^0 + \mathbf{T}_{ji} \mathbf{u}_i + \mathbf{T}_{ji}^c \mathbf{u}_i^c - \mathbf{s}_j)' \mathbf{Q}_j \\ &\times (\mathbf{V}_j x^0 + \mathbf{T}_{ji} \mathbf{u}_i + \mathbf{T}_{ji}^c \mathbf{u}_i^c - \mathbf{s}_j) + \mathbf{u}_i' \mathbf{R}_i \mathbf{u}_i + (\mathbf{u}_i^c)' \mathbf{R}_i^c \mathbf{u}_i^c \\ &= (\mathbf{u}_i^c)' \mathbf{H} \mathbf{u}_i^c + 2(x^0)' \mathbf{h}_1 \mathbf{u}_i^c + 2\mathbf{u}_i' \mathbf{h}_2 \mathbf{u}_i^c \\ &- 2 \sum_{j=1}^N \mathbf{s}_j' \mathbf{Q}_j \mathbf{T}_{ji}^c \mathbf{u}_i^c + \text{const} \end{aligned} \quad (5)$$

where

$$\begin{aligned} \mathbf{T}_{ji}^c &= \begin{bmatrix} C_j B_i^c & 0 & \dots & 0 \\ C_j A B_i^c & C_j B_i^c & \dots & 0 \\ \dots & \dots & \dots & \dots \\ C_j A^{P-1} B_i^c & C_j A^{P-2} B_i^c & \dots & C_j B_i^c \end{bmatrix}, \\ B_i^c &= [B_1 | \dots | B_{i-1} | 0 | B_{i+1} | \dots | B_N], \\ \mathbf{R}_i^c &= \text{diag}\{R_i^c\}, \\ R_i^c &= \text{diag}\{R_1^c, \dots, R_{i-1}^c, 0, R_{i+1}^c, \dots, R_N^c\}, \\ \mathbf{H} &= \sum_{j=1}^N (\mathbf{T}_{ji}^c)' \mathbf{Q}_j \mathbf{T}_{ji}^c + \mathbf{R}_i^c, \\ \mathbf{h}_1 &= \sum_{j=1}^N \mathbf{V}_j' \mathbf{Q}_j \mathbf{T}_{ji}^c, \mathbf{h}_2 = \sum_{j=1}^N \mathbf{T}_{ji}' \mathbf{Q}_j \mathbf{T}_{ji}^c, \end{aligned}$$

Considering optimization problem (5) under constraints (4), the manipulated variables of non-faulty subsystems \mathbf{u}_i^c is

$$\begin{aligned} \mathbf{u}_i^c &= \mathbf{H}^{-1} \left(\tilde{\mathbf{G}}' \left(\tilde{\mathbf{G}} \mathbf{H}^{-1} \tilde{\mathbf{G}}' \right)^{-1} \tilde{\mathbf{G}} \mathbf{H}^{-1} - \mathbf{I} \right) \\ &\times \left(\mathbf{h}_1' x^0 + \mathbf{h}_2' \mathbf{u}_i - \sum_{j=1}^N (\mathbf{T}_{ji}^c)' \mathbf{Q}_j \mathbf{s}_j \right) \\ &- \mathbf{H}^{-1} \left(\tilde{\mathbf{G}}' \left(\tilde{\mathbf{G}} \mathbf{H}^{-1} \tilde{\mathbf{G}}' \right)^{-1} \left(\tilde{\mathbf{G}}^x x^0 + \tilde{\mathbf{G}}^i \mathbf{u}_i + \tilde{\mathbf{g}} \right) \right) \\ &= \mathbf{W} + \mathbf{W}^1 x^0 + \mathbf{W}^2 \mathbf{u}_i + \sum_{j=1}^N \mathbf{W}_j^3 \mathbf{s}_j, \end{aligned} \quad (6)$$

where

$$\begin{aligned} \Phi &= \tilde{\mathbf{G}}' \left(\tilde{\mathbf{G}} \mathbf{H}^{-1} \tilde{\mathbf{G}}' \right)^{-1}, \\ \mathbf{W} &= -\mathbf{H}^{-1} \Phi \tilde{\mathbf{g}}, \\ \mathbf{W}^1 &= \mathbf{H}^{-1} \left((\Phi \tilde{\mathbf{G}} \mathbf{H}^{-1} - \mathbf{I}) \mathbf{h}_1' - \Phi \tilde{\mathbf{G}}^x \right), \\ \mathbf{W}^2 &= \mathbf{H}^{-1} \left((\Phi \tilde{\mathbf{G}} \mathbf{H}^{-1} - \mathbf{I}) \mathbf{h}_2' - \Phi \tilde{\mathbf{G}}^i \right), \\ \mathbf{W}_j^3 &= -\mathbf{H}^{-1} (\Phi \tilde{\mathbf{G}} \mathbf{H}^{-1} - \mathbf{I}) (\mathbf{T}_{ji}^c)' \mathbf{Q}_j. \end{aligned} \quad (7)$$

At this stage, the manipulated variables related to the non-faulty subsystems have been expressed according to (6). Substituting the value of manipulated variables related to non-faulty subsystems (6) to the MPC objective (5) and denoting

$$\mathbf{f}_j = \mathbf{V}_j x^0 + \mathbf{T}_{ji}^c \left(\mathbf{W} + \mathbf{W}^1 x^0 + \sum_{j=1}^N \mathbf{W}_j^3 \mathbf{s}_j \right) - \mathbf{s}_j \quad (8)$$

then the MPC objective (5) can be represented as

$$\begin{aligned}
& \min_{\mathbf{u}_i} \sum_{j=1}^N (\mathbf{f}_j + (\mathbf{T}_{ji} + \mathbf{T}_{ji}^c \mathbf{W}^2) \mathbf{u}_i)' \mathbf{Q}_j \\
& \times (\mathbf{f}_j + (\mathbf{T}_{ji} + \mathbf{T}_{ji}^c \mathbf{W}^2) \mathbf{u}_i) + \mathbf{u}_i' \mathbf{R}_i \mathbf{u}_i \\
& + \left(\mathbf{W} + \mathbf{W}^1 x^0 + \mathbf{W}^2 \mathbf{u}_i + \sum_{j=1}^N \mathbf{W}_j^3 \mathbf{s}_j \right)' \mathbf{R}_i^c \\
& \times \left(\mathbf{W} + \mathbf{W}^1 x^0 + \mathbf{W}^2 \mathbf{u}_i + \sum_{j=1}^N \mathbf{W}_j^3 \mathbf{s}_j \right) \\
& = \mathbf{u}_i' \mathbf{F} \mathbf{u}_i + 2 \left(\sum_{j=1}^N \mathbf{f}_j' \mathbf{Q}_j (\mathbf{T}_{ji} + \mathbf{T}_{ji}^c \mathbf{W}^2) \right. \\
& \left. + \left(\mathbf{W} + \mathbf{W}^1 x^0 + \sum_{j=1}^N \mathbf{W}_j^3 \mathbf{s}_j \right) \mathbf{R}_i^c \mathbf{W}^2 \right) \mathbf{u}_i + \text{const} \quad (9)
\end{aligned}$$

where

$$\begin{aligned}
\mathbf{F} &= \sum_{j=1}^N (\mathbf{T}_{ji} + \mathbf{T}_{ji}^c \mathbf{W}^2)' \mathbf{Q}_j (\mathbf{T}_{ji} + \mathbf{T}_{ji}^c \mathbf{W}^2) \\
&+ (\mathbf{W}^2)' \mathbf{R}_i^c (\mathbf{W}^2) + \mathbf{R}_i. \quad (10)
\end{aligned}$$

Minimizing individual MPC objective (9) under linear constraints (3) gives \mathbf{u}_i , and the rest of the non-faulty manipulated variables can be obtained using (6).

Finally, the procedure for the dynamic prognosis is summarized as follows

- 1) Set the current time t to 0.
- 2) Considering the active constraints in the non-faulty subsystems remain the same as they are in nominal operating conditions (4), the manipulated variables related to the non-faulty subsystems \mathbf{u}_i^c can be expressed as linear functions of the current plant state x^0 , the manipulated variables related to the faulty subsystem \mathbf{u}_i and the setpoints \mathbf{s}_j .
- 3) The objective function of the local MPC related to faulty subsystem is defined according to (9), where the necessary coefficients are obtained by (8) and (10).
- 4) The optimization of the local MPC (9) related to the faulty subsystem is performed to derive \mathbf{u}_i , then manipulated variables of other subsystems \mathbf{u}_i^c are obtained according to (6).
- 5) The obtained manipulated values are substituted to the faulty system dynamics to obtain the predictions of the actual states.
- 6) Increase the time index as $t = t + 1$ and shift the active constraints set of non-faulty subsystems accordingly, then go to step 2 until the end of prediction horizon.

IV. SIMULATION RESULT

A. Process description and control strategy

The alkylation of benzene is a benchmark process that has been used in the DMPC [16] and DFTMPC [13], [14]. The plant consists of five units as shown in Fig 2, i.e. four continuous stirred-tank reactors (CSTR) and one flash separator.

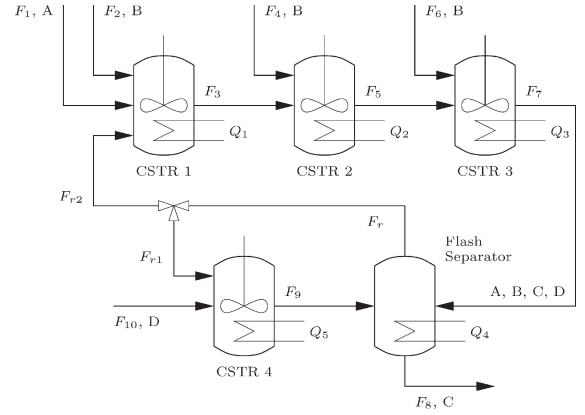

Fig. 2. Process flow diagram for alkylation of benzene [16]

TABLE I
STEADY-STATE INPUTS AND TEMPERATURES

$u_{1s} = -2.0 \text{ MJ/s}$	$u_{7s} = 8.697 \times 10^{-4} \text{ m}^3/\text{s}$
$u_{2s} = -2.0 \text{ MJ/s}$	$T_{1s} = 472.32 \text{ K}$
$u_{3s} = -2.0 \text{ MJ/s}$	$T_{2s} = 472.35 \text{ K}$
$u_{4s} = 4.1 \text{ MJ/s}$	$T_{3s} = 472.39 \text{ K}$
$u_{5s} = -0.01 \text{ MJ/s}$	$T_{4s} = 471 \text{ K}$
$u_{6s} = 8.697 \times 10^{-4} \text{ m}^3/\text{s}$	$T_{5s} = 474 \text{ K}$

In the normal condition, the manipulated inputs to the process are the heat injected to or removed from the five tanks, Q_1 , Q_2 , Q_3 , Q_4 and Q_5 (u_1 , u_2 , u_3 , u_4 and u_5 , respectively). The feed stream flow rates to CSTR 2 and CSTR 3, F_4 and F_6 , are the back-up manipulated variables (u_6 and u_7) which are activated for the controller reconfiguration when a fault is detected and diagnosed. The steady-state inputs, u_{is} , $i = 1, \dots, 7$, as well as the steady-state temperatures in the five tanks (controlled variables) are shown in Table I.

In this work, the sensitivity-driven DMPC in [16] is utilized as the base controller for the alkylation of benzene process. The whole system is divided into two groups, one includes CSTR 1, CSTR 2 and CSTR3, the other contains CSTR 4 and the flash separator. Thus, the first local MPC (LMPC1) controls the values of Q_1 , Q_2 and Q_3 , and the second local MPC (LMPC2) controls the values of Q_4 and Q_5 . These two local controllers exchange information in the process operation.

The inputs are discretized as a piecewise constant with sampling time $t = 10s$. The control horizon is $L = 5$, and the prediction horizon is $P = 20$. The constraints of manipulated inputs and temperatures are shown in Table II.

TABLE II
CONSTRAINTS OF MANIPULATED INPUTS AND TEMPERATURES

$ \Delta u_1 \leq 0.75 \text{ MJ/s}$	$ \Delta u_7 \leq 2 \times 10^{-3} \text{ m}^3/\text{s}$
$\Delta u_2 \leq 0.5 \text{ MJ/s}$	$471 \leq T_1 \leq 474 \text{ K}$
$\Delta u_3 \leq 0.5 \text{ MJ/s}$	$471 \leq T_2 \leq 474 \text{ K}$
$\Delta u_4 \leq 0.6 \text{ MJ/s}$	$471 \leq T_3 \leq 474 \text{ K}$
$\Delta u_5 \leq 0.6 \text{ MJ/s}$	$471 \leq T_4 \leq 474 \text{ K}$
$\Delta u_6 \leq 2 \times 10^{-3} \text{ m}^3/\text{s}$	$471 \leq T_5 \leq 474 \text{ K}$

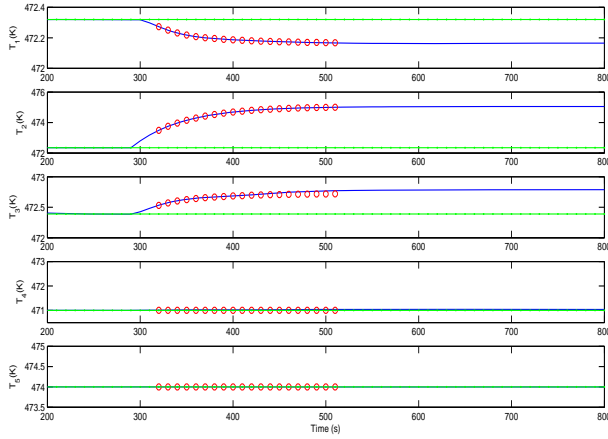

Fig. 3. Test results with existing actuators and current operating point (green dot dash line: setpoint; blue solid line: temperature variations; red dot line: dynamic prognosis trajectory)

B. Case studies

1) *Case study 1: evaluating candidate controller reconfigurations:* Firstly, when a fault is diagnosed, the current operating point is checked to determine if it is feasible under the original control strategy. We consider an actuator fault occurs at $t = 300s$: u_2 is frozen at 95% of its steady-state value. Obviously, the temperature in CSTR 2 will be increasing from that time if no FTC is implemented. Figure 3 shows the test result with existing actuators and current operating point. It shows directly that the current operating point is not feasible without changing the controller configuration, which is verified by the result under DMPC.

One possible solution is to activate another actuator in order to compensate for the efficiency loss in u_2 . To demonstrate the function of dynamic prognosis, two back-up control reconfigurations are investigated. The first is to activate the feed stream flow rates to CSTR 2, u_6 , and the second is to activate the feed stream flow rates to CSTR 3, u_7 . Figure 4 and Figure 5 depict the test result with activating u_6 and u_7 under the current operating point respectively. From Figure 4, it is clear to see that the temperatures can be driven to setpoint after 12 steps under the effect of u_6 . While Figure 5 demonstrates irrefutably that activating u_7 does not make much difference. After the comparison, it can be decided to implement the first control reconfiguration at $t = 310s$, which will result in the temperatures converging to the setpoint with newly designed controller at $t = 430s$.

2) *Case study 2: checking newly defined operating point:* In case that the current operating point is not feasible with either original control strategy or any reconfigured controllers, another operating point must be designed based on the characteristics of the fault. We consider an actuator fault at $t = 300s$: u_1 is frozen at 97.5% of its steady-state value, and obviously, the temperature in CSTR 1 will be increasing from that time. At time $t = 320s$, the fault has been detected and diagnosed. It is clear that the fault in

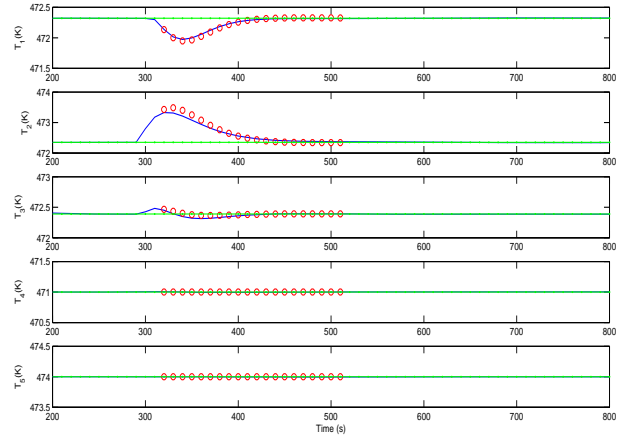

Fig. 4. Test results with activating u_6 and current operating point (green dot dash line: setpoint; blue solid line: temperature variations; red dot line: dynamic prognosis trajectory)

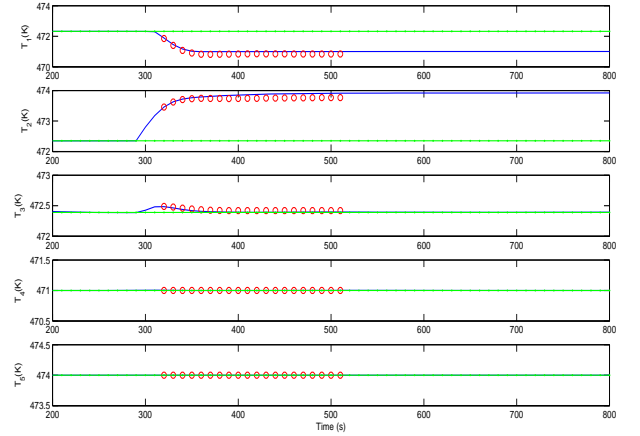

Fig. 5. Test results with activating u_7 and current operating point (green dot dash line: setpoint; blue solid line: temperature variations; red dot line: dynamic prognosis trajectory)

u_1 in CSTR 1 cannot be compensated by current control strategy or activating u_6 and u_7 in CSTR 2 and 3 as shown in Figure 6. Thus, one possible solution is to increase the setpoint for T_1 within the constraints. Another choice is to decrease the setpoint for the temperature in the flash separator, T_4 . Since the recycled vapor stream goes from flash separator to CSTR 1, the cooling of this stream can also lead to the decreasing of T_1 . The new operating point is designed as: $T_{1s} = 473.36K$, $T_{2s} = 472.35K$, $T_{3s} = 472.39K$, $T_{4s} = 471.00K$, $T_{5s} = 473.00K$. Figure 7 shows the dynamic prognosis result for the future 20 steps with new setpoint. It can be clearly seen that both second and third controllers can obtain very good performance. After checking the difference between the predicted trajectory and setpoint, it was found that the third controller performs slightly better than the second one and as a result, u_7 is activated. The test result with activating u_7 and the newly designed operating point is

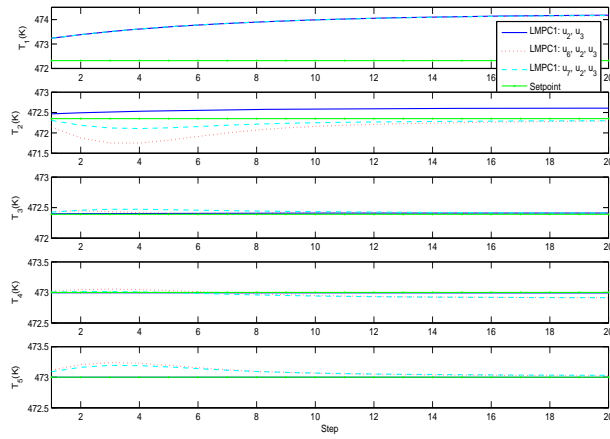

Fig. 6. Dynamic prognosis result for the future 20 steps with current setpoint at time $t = 320s$

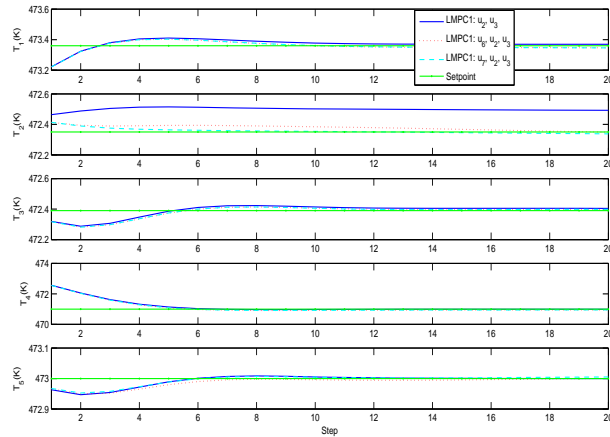

Fig. 7. Dynamic prognosis result for the future 20 steps with newly designed setpoint at time $t = 320s$

shown in Figure 8.

V. CONCLUSION

This paper presents a dynamic prognosis algorithm in DFTMPC systems. Under the assumption that the active constraints in non-faulty subsystems remain the same, the dynamic prognosis consider the optimization of the only local MPC instead of handling the whole DMPC. Thus, the on-line computation burden of the dynamic prognosis is moderate.

ACKNOWLEDGMENT

This work is supported by Academy of Finland Project under Grant No. 13138194.

REFERENCES

[1] S. J. Qin and T. A. Badgwell, "A survey of industrial model predictive control technology," *Control engineering practice*, vol. 11, no. 7, pp. 733–764, 2003.

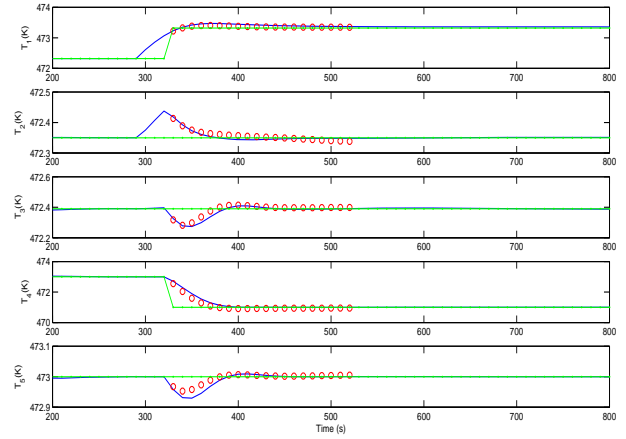

Fig. 8. Test results with activating u_7 and newly designed operating point (green dot dash line: setpoint; blue solid line: temperature variations; red dot line: dynamic prognosis trajectory)

[2] A. V. Zakharov, H. S. Bosman, and S.-L. Jämsä-Jounela, "Two-phase model predictive control and its application to the tennessee eastman process," *Industrial & Engineering Chemistry Research*, vol. 52, no. 36, pp. 12937–12949, 2013.

[3] Y. Zhang and J. Jiang, "Bibliographical review on reconfigurable fault-tolerant control systems," *Annual Reviews in Control*, vol. 32, no. 2, pp. 229–252, 2008.

[4] S. X. Ding, *Model-based fault diagnosis techniques*. Springer, 2008.

[5] T. Jain, J. J. Yame, and D. Sauter, "A novel approach to real-time fault accommodation in nrel's 5-mw wind turbine systems," *IEEE Transactions on Sustainable Energy*, vol. 4, no. 4, pp. 1082–1090, 2013.

[6] M. Sourander, M. Vermasvuori, D. Sauter, T. Liikala, and S.-L. Jämsä-Jounela, "Fault tolerant control for a dearomatization process," *Journal of Process Control*, vol. 19, no. 7, pp. 1091–1102, 2009.

[7] M. Kettunen, P. Zhang, and S.-L. Jämsä-Jounela, "An embedded fault detection, isolation and accommodation system in a model predictive controller for an industrial benchmark process," *Computers & Chemical Engineering*, vol. 32, no. 12, pp. 2966–2985, 2008.

[8] M. Kettunen and S.-L. Jämsä-Jounela, "Data-based, fault-tolerant model predictive control of a complex industrial dearomatization process," *Industrial & Engineering Chemistry Research*, vol. 50, no. 11, pp. 6755–6768, 2011.

[9] A. Gani, P. Mhaskar, and P. D. Christofides, "Fault-tolerant control of a polyethylene reactor," *Journal of Process Control*, vol. 17, no. 5, pp. 439–451, 2007.

[10] D. Chilin, J. Liu, X. Chen, and P. D. Christofides, "Fault detection and isolation and fault tolerant control of a catalytic alkylation of benzene process," *Chemical Engineering Science*, vol. 78, pp. 155–166, 2012.

[11] R. Gandhi and P. Mhaskar, "A safe-parking framework for plant-wide fault-tolerant control," *Chemical Engineering Science*, vol. 64, no. 13, pp. 3060–3071, 2009.

[12] —, "Safe-parking of nonlinear process systems," *Computers & Chemical Engineering*, vol. 32, no. 9, pp. 2113–2122, 2008.

[13] D. Chilin, J. Liu, J. F. Davis, and P. D. Christofides, "Data-based monitoring and reconfiguration of a distributed model predictive control system," *International Journal of Robust and Nonlinear Control*, vol. 22, no. 1, pp. 68–88, 2012.

[14] D. Chilin, J. Liu, D. Muñoz de la Peña, P. D. Christofides, and J. F. Davis, "Detection, isolation and handling of actuator faults in distributed model predictive control systems," *Journal of Process Control*, vol. 20, no. 9, pp. 1059–1075, 2010.

[15] S.-L. Jämsä-Jounela, "Outline of a fault diagnosis system for a large-scale board machine," *International journal, advanced manufacturing technology*, vol. 65, no. 9-12, pp. 1741–1755, 2013.

[16] H. Scheu and W. Marquardt, "Sensitivity-based coordination in distributed model predictive control," *Journal of Process Control*, vol. 21, no. 5, pp. 715–728, 2011.