

This material is posted here with permission of the IEEE. Such permission of the IEEE does not in any way imply IEEE endorsement of any of Helsinki University of Technology's products or services. Internal or personal use of this material is permitted. However, permission to reprint/republish this material for advertising or promotional purposes or for creating new collective works for resale or redistribution must be obtained from the IEEE by writing to [pubs-permissions@ieee.org](mailto:pubs-permissions@ieee.org).

By choosing to view this document, you agree to all provisions of the copyright laws protecting it.

# MODELING AND ANALYSIS OF A TWO-PHASE INDUCTION MACHINE WITH NON-ORTHOGONAL STATOR WINDINGS

M. Popescu, *Member, IEEE* E. Demeter, *Member, IEEE*  
 Research Institute for Electrical Machines, Bucharest, Romania  
 Bd. Tudor Vladimirescu 45, RO- 79623, E-mail: mirceap@ieec.org; office@elma.eunet.ro;

T. Jokinen  
 Helsinki University of Technology, Laboratory Electromechanics, Finland  
 P.O.BOX - 3000, 02015 - HUT, E-mail: Tapani.Jokinen@hut.fi

V. Navrapescu  
 University "Politehnica" Bucharest, Dept. Electrical Engineering, Romania.  
 Spl. Independentei 313; E-mail: valin@temp.eltech.pub.ro

**Abstract** - This paper extent the stationary reference frame [1], to the modeling and analysis of the torque behavior of a two-phase unsymmetrical induction machine with a shifted auxiliary winding. By computer simulation, compared with experimental results, it is verified the influence of the electrical auxiliary phase stator shift over the machine's torque and currents. The analysis is made for steady-state and transient state operation.

The two-phase induction machine (TPIM) is widely used in many light-duty applications were three-phase supply is not readily available. During the development of such a machine, there are several options, including the spatial placement of the auxiliary winding. The torque-slip characteristics can be manipulated by shifting the auxiliary winding from the quadrature position.

The analysis of the single-phase or two-phase induction machine with a shifted auxiliary winding was made by including time domain equivalent circuit [2], symmetrical components [3], or multiple reference frames [4]. The first two methods are acceptable for analyzing the steady-state performance of the machine, while the third method involves too many equations and variables in order to describe the dynamic performance of the TPIM.

## I. MATHEMATICAL MODEL

This paper proposes a mathematical model in stationary reference frame for the two-phase induction machine with a shifted auxiliary winding. This model permits the prediction of the transient or steady state performance of the machine for fixed-frequency supply or for variable voltage-frequency supply.

Once developed, the model is verified by comparing the measured steady-state torque slip curves of the TPIM for three values of the electrical auxiliary phase stator shift, to that obtained by a computer simulation based on the model set forth herein. The mathematical model of a TPIM with orthogonal stator windings [1] can be obtained from this proposed model, by setting the electrical shift angle to zero. It is assumed that the stator windings are sinusoidal distributed, and that the machine is magnetically linear. The

iron losses have been neglected.

The following voltage and flux linkage equations can be used:

$$v_{QS} = R_m i_{QS} + \frac{p}{\omega_b} \psi_{QS} \quad (1)$$

$$v_{DS} = R_a i_{DS} + \frac{p}{\omega_b} \psi_{DS} \quad (2)$$

$$0 = R_r i_{QR} - \frac{1}{k} \frac{\omega_r}{\omega_b} \psi'_{DR} + \frac{p}{\omega_b} \psi'_{QR} \quad (3)$$

$$0 = k^2 R_r i_{DR} + k \frac{\omega_r}{\omega_b} \psi'_{QR} + \frac{p}{\omega_b} \psi'_{DR} \quad (4)$$

$$\psi_{QS} = (X_{sm} + X_m) i_{QS} - k X_m \sin \varphi_a i_{DS} + X_m i'_{QR} \quad (5)$$

$$\psi_{DS} = -k X_m \sin \varphi_a i_{QS} + (X_{sa} + k^2 X_m) i_{DS} - k X_m \sin \varphi_a i'_{QR} + k^2 X_m \cos \varphi_a i'_{DR} \quad (6)$$

$$\psi'_{QR} = X_m i_{QS} - k X_m \sin \varphi_a i_{DS} + (X_{sr} + X_m) i'_{QR} \quad (7)$$

$$\psi'_{DR} = k^2 X_m \cos \varphi_a i_{DS} + k^2 (X_{sr} + X_m) i'_{DR} \quad (8)$$

$$T_e = \frac{p X_m}{2 \omega_b} k (i_{QS} i'_{DR} - i_{DS} i'_{QR} \cos \varphi_a - k i_{DS} i'_{DR} \sin \varphi_a) \quad (9)$$

$$p \omega_r = \frac{T_e - T_l}{J} \quad (10)$$

Where

$v_{QS}$  and  $v_{DS}$  - QS and DS-axis stator voltages,  
 $R_m$ ,  $X_{sm}$  and  $R_a$ ,  $X_{sa}$  - QS and DS-axis resistance and leakage reactance,  
 $X_m$  - magnetization reactance  
 $\varphi_a$  - electrical shift angle,  
 $p$  - differential operator  $d/dt$ ,  
 $\omega_b$ ,  $\omega_r$  - base angular speed for calculating the impedances and rotor electric angular speed,  
 $\psi_{QS}$  and  $\psi_{DS}$  - QS and DS-axis stator linkage fluxes per second,  
 $i'_{QR}$  and  $i'_{DR}$  - referred QR and DR-axis rotor currents,

$R_r$  and  $X_{sr}$  - QS-axis rotor resistance and leakage reactance,  
 $\psi'_{QR}$  and  $\psi'_{DR}$  - referred QR and DQ-axis rotor linkage fluxes per second,

$i_{QS}$  and  $i_{DS}$  - QS and DS-axis stator currents,

$k$  - turn ratio of equivalent auxiliary and main windings,

$T_e$ ,  $T_l$  - electromagnetic instantaneous torque and load torque,

$J$  - inertia constant of motor,

$P$  - number of poles.

A machine mathematical model with non-orthogonal stator windings in stationary reference frame is presented in Fig. 1.

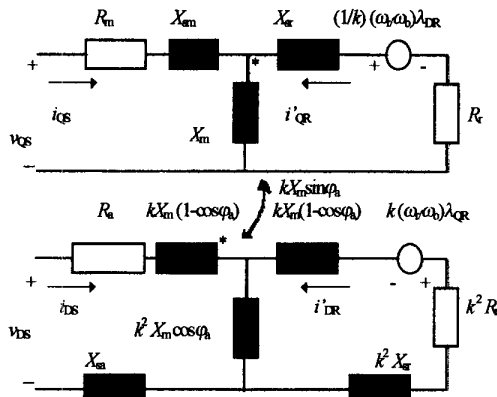

Fig. 1. Equivalent circuit of a two-phase induction machine with non-orthogonal stator windings

The positive direction for the electrical shift angle  $\phi_a$  is opposite the direction of rotation. The mechanical shift angle is obtained by dividing the electrical one with  $P/2$ , where  $P$  denotes the number of magnetic poles.

## II. STEADY-STATE OPERATION ANALYSIS

The analyzed machine can operate as split-phase or capacitor run induction machine. For measuring and simulation both windings have been considered energized. The 2 pole, 220 V/50Hz, 60 W two-phase induction machine has the parameters listed in Table I.

An optimum strategy of supplying a TPIM, without using a capacitor, is obtained when the main and the auxiliary voltages are linked by the following relation [5]:

$$\tilde{V}_a = jk\tilde{V}_m \quad (11)$$

where the tilled denotes complex values and  $j$  is the complex operator.

Simulation was realized by using a MATLAB program. The steady-state operation can be described by substituting in equation (1)-(10) the differential operator  $j\omega$ .

Fig. 2. illustrates the torque-slip characteristics of a TPIM for different values of the electrical shift angle. Note that that negative value have effect in a certain increase

starting torque, and the positive values in a decreased starting torque but higher break-down and rated torque. Also, a reduced pulsating torque is obtained for some positive values of the electrical shift angle and increased for negative ones. Star data represent the torque-speed characteristics measured experimentally for three values of the electrical shift angle:  $-0.393$  ad;  $0$  ad;  $+0.393$  ad. In can be observed that the model set forth herein matches the measured results.

TABLE I  
TPIM Parameters

$k$	0.47	$R_r$	76 $\Omega$	$X_{sa}$	7 $\Omega$
$\phi_a$	+/- 0.393 ad	$X_{sm}$	22 $\Omega$	$X_m$	706 $\Omega$
$J$	0.0004 kgm <sup>2</sup>	$X_{sr}$	29 $\Omega$	$P$	2
$R_m$	37 $\Omega$	$R_a$	56 $\Omega$	$V_A$	103.5 V

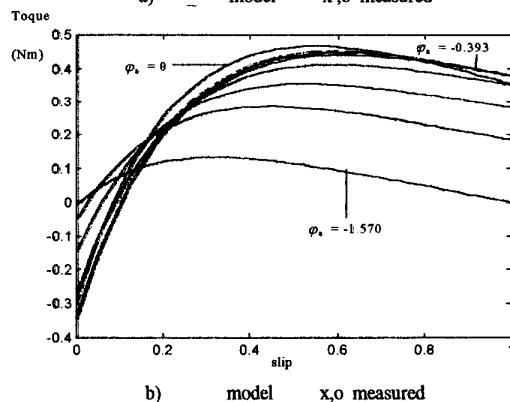
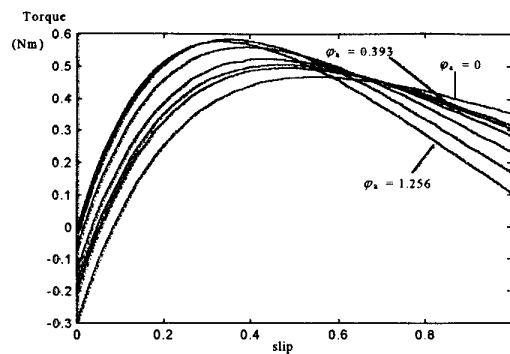

Fig. 2. Torque-slip characteristics of a two-phase induction machine with non-orthogonal stator windings for different values of the electrical shift angle: a)  $\phi_a > 0$ ; b)  $\phi_a < 0$ .

In Fig. 3 and 4 is depicted the simulated pulsating torque variation for the same values of the electrical shift angle. The TPIM with non-orthogonal stator windings is characterized by diminished pulsating torque when it operates as split-phase induction motor and the electrical shift angle is positive (opposite sense to the rotation direction).

The explanation of this phenomenon consists in:  
a) the weakening the reverse magnetic field component;  
b) the increase of the forward component of the magnetic field.

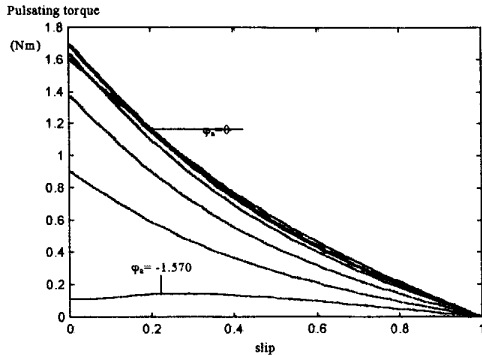

Fig. 3. Pulsating torque variation for negative electrical angle shift

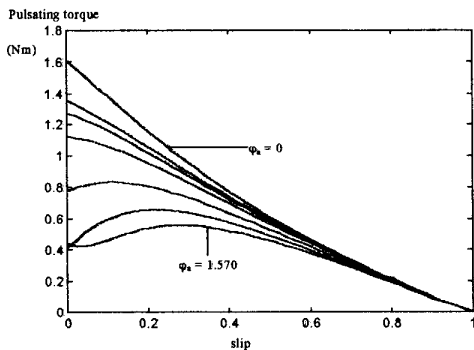

Fig. 4. Pulsating torque variation for positive electrical shift angle

### III. TRANSIENT STATE OPERATION ANALYSIS

For a TPIM, the dynamic analysis represents an important task, since one can obtain information regarding current and torque behavior for any load modification.

A SIMULINK program was implemented using equation (1)-(10). Simulations presented in Fig. 5 are valid for no-load starting period, with supply strategy described by (11). The balanced operation conditions are described by the relations between the two axis currents [1].

Fig. 5 shows the transient variation of the DS axis current vs. QS axis current. The mutual flux linkage corresponding to the stator windings, due to the electrical shift angle, determines different variation of the currents. When  $\phi_a$  is negative, the current variation shape is more elliptical. This phenomenon explicates the higher pulsating torque and magnetic noise. The positive value of  $\phi_a$  determines the evolution of the two axis currents toward a quasi-balanced operation of the TPIM [1].

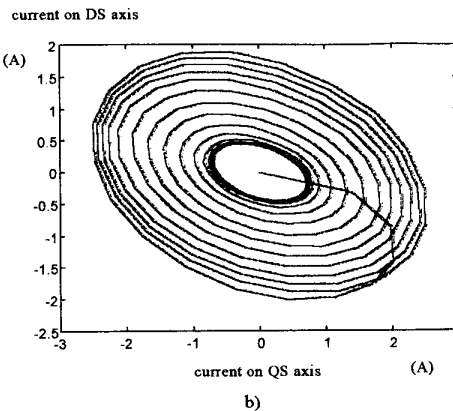
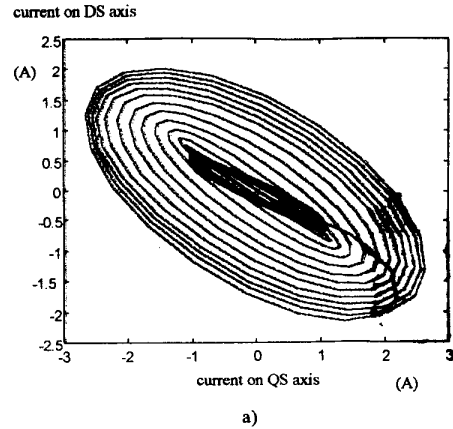

Fig. 5. Transient variation of current in axis DS vs. current in axis QS during no-load starting: a)  $\phi_a = -0.393$  rad; b)  $\phi_a = +0.393$  rad

### IV. CONCLUSIONS

The steady state and dynamic behavior of a TPIM with non-orthogonal stator windings is analyzed. supplied from variable voltage-variable frequency devices, may be analyzed as well. The same conclusions are valid for this situation:

- 1) higher break-down and rated torque, lower pulsating and starting torque for some positive values of the electrical shifted angle;
- 2) higher starting and pulsating torque, lower rated and break down torque for some negative values of the electrical shifted angle.

### REFERENCES

1. Krause, P.C., Wasynczuk, O., Sudhoff, S.D.: *Analysis of Electric Machinery*, IEEE Press, 1995
2. Puuchstein, A.F., Lloyd, T.C.: *Capacitor Motors with Winding not in Quadrature*, AIEE Trans, Nov. 1935. p. 1235-1239
3. Lyon, W.V., Kingsley, C. jr.: *Analysis of Unsymmetrical Machines*, AIEE Trans, may 1936, p.471-476.
4. Walls, T.A., Sudhoff, S.D.: *Analysis of a single-phase induction machine with a shifted auxiliary winding*, IEEE, Trans. on Energy Conversion, dec. 1996, p.681-686