

# IV

T. Lampén, V. Karimäki, S. Saarinen, O. Buchmüller, Alignment of the Cosmic Rack with the Hits and Impact Points Algorithm, CMS Note 2006/006, CERN, Geneva, Switzerland, 8pp., Copyright (2006) by authors.

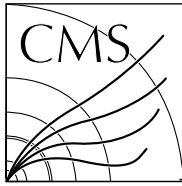

The Compact Muon Solenoid Experiment

# CMS Note

Mailing address: CMS CERN, CH-1211 GENEVA 23, Switzerland

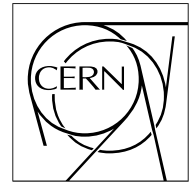

January 23, 2006

## Alignment of the Cosmic Rack with the Hits and Impact Points Algorithm

T. Lampén, V. Karimäki, S. Saarinen

*Helsinki Institute of Physics, Finland*

O. Buchmüller

*CERN, Geneva, Switzerland*

### Abstract

We present first results of a track based alignment procedure applied to test beam data recorded with Cosmic Rack, a test setup which mimicks the outer barrel of the CMS Tracker. The Hits and Impact Points alignment method is used within the CMS reconstruction software framework to align this telescope-like device. These results were compared to results obtained with manual alignment and to results obtained with the Millepede algorithm. This study demonstrates that the software implementation of the recently developed alignment tools works properly and also represents the first track based alignment results in CMS using real data.

# 1 Introduction

In order to ensure an efficient and accurate operation of the track reconstruction in CMS, a proper alignment of all CMS tracking devices is mandatory. In particular the CMS Silicon Tracker with its large number of independent sensors, approximately 20000, and their excellent intrinsic resolution ranging from about  $10\ \mu\text{m}$  to about  $50\ \mu\text{m}$  makes the alignment of the CMS tracking devices a complex and very challenging task. The most important alignment method is track based alignment, which is the only available method to align individual sensors. For some parts of CMS, alignment can be carried out to some extent with specific optical and laser devices. However, important parts of the tracker are out of reach of these devices (i.e., Pixel), and their resolution would be devastated by mechanical misalignments, if track based alignment was not used. The typical mechanical constraints in the barrel region are of some hundred  $\mu\text{m}$ , an order of magnitude larger than the intrinsic resolution of the sensors[1].

The general approach for tracker alignment is to first use the laser alignment system to determine alignment corrections for global support structures, and then to finalize the alignment with reconstructed tracks down to the sensor level. Therefore, track based alignment is the most important ingredient of the tracker alignment concept.

While it is crucial to demonstrate with simulated data the capability to align the full CMS tracker with track based alignment procedures, the results described in this note complement this verification effort with an independent approach, using test beam data recorded with a small-scale system.

The software framework used in these studies is very similar to the standard CMS reconstruction framework ORCA[2]. Some modifications due to the test setup geometry were needed to the existing tracking algorithms, to the alignment tools (used to move detector modules from their nominal positions) and to the alignment interface, which is a common interface for different alignment algorithms. Other than these minor, mainly geometry related modifications, the reconstruction framework used is identical to the standard ORCA.

The outline of this paper is as follows: the test setup is presented in section 2, and the alignment method is presented in section 3. Details of data taking and track reconstruction are described in section 4. Results are presented in section 5, and future plans in section 6.

## 2 Cosmic racks

The CERN TOB Cosmic Rack (CRack) and the Finnish Cosmic Rack (FinnCRack) are two similar and independent devices where genuine CMS modules of the tracker outer barrel (TOB) sub-detector are operated in a telescope-like structure. They provide all the necessary equipment and connections for the CMS-like operation of the detectors. They are being used as part of the TOB integration and verification effort, and also provide a unique possibility to study track based alignment algorithms with real data.

The cosmic racks consist of 10 layers, which can hold two TOB rods each (see Figs. 1 and 2). Their geometry mimicks a six degree sector in the TOB barrel structure. Each TOB rod can host 6 modules measuring only one coordinate (the r-phi modules) or 12 modules arranged in 6 pairs measuring both coordinates (the stereo modules). In the stereo modules one sensor is rotated by a small angle, which enables measurement of both coordinates.

The sensors consist of n-type bulk material with a  $p^+$  implantation on their front side. Each sensor is manufactured from a single wafer with  $\langle 100 \rangle$  orientation using 6" technology. The sensors are reverse-biased, AC-coupled strip sensors with a pitch of 122 or 183  $\mu\text{m}$  and a width/pitch ratio of 0.25. [3]

In this note we use test beam data from September 2004 for the alignment studies. The test beam data have been recorded with the TOB Cosmic Rack in the X5 beam. There also exists cosmic data recorded in July 2005, but these data were not considered in this study<sup>1)</sup>.

## 3 HIP alignment method

Several track based alignment methods are currently in development, and will be described in the CMS Physics TDR (Technical Design Report). For this study we primarily use the Hits and Impact Points method (HIP method)[4, 5]. In this iterative algorithm hit coordinates as well as coordinates of the impact points of the tracks are collected for each alignable sensor, and after all data are collected, the individual sensors are aligned independently. A couple of iterations consisting of track reconstruction and alignment of the sensors are usually needed.

---

<sup>1)</sup> This first dataset of cosmic data was recorded with the FinnCRack DAQ installation and the CERN TOB Cosmic Rack.



Figure 1: FinnCRack. The CERN Cosmic Rack is practically identical from the alignment point of view.

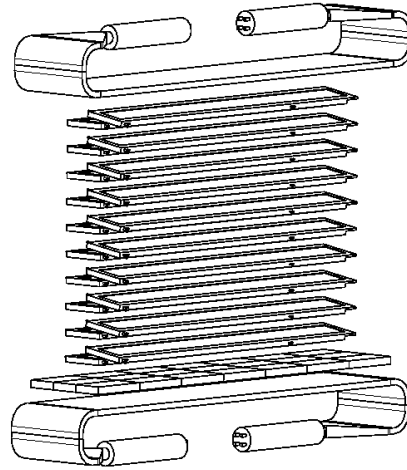

Figure 2: Schematic view of rods and scintillators in the fully equipped TOB Cosmic Rack.

The algorithm was run within the CMS Reconstruction software ORCA with a revised version of the Alignment Tools package, which is needed to change sensor positions and orientations.

The HIP algorithm is able to determine up to 6 alignment parameters for each individual sensor. It involves an analytic formula of the hit residuals as a function of the alignment parameters of  $N$  selected individual modules. A  $\chi^2$  function, depending on the alignment parameters, is constructed from the residuals. The minimizing procedure for the  $6N$  alignment parameters involves a block diagonal  $6N \times 6N$  matrix whose inversion reverts to the inversion of individual  $6 \times 6$  matrix blocks so that inversion of very large matrices is avoided. The implementation of the method allows to fix a subset of parameters for all or for chosen modules. The method is described in detail in [4].

In the HIP method alignment parameters are updated only after accumulating all the selected track and hit entries. This approach has the benefit that it does not easily end up in a local minimum, because maximum amount of data is collected before solving for the alignment parameters. The iteration in the method involves consecutive cycles of performing the alignment and re-fitting particle tracks, until no further improvement in the track reconstruction is obtained.

An alternative implementation of the algorithm is designed to align a larger detector structure for common rotation and translation [5]. Such 'composite' entities are for example the TOB rods. The composite alignment involves only the six parameters of the composite object, and therefore a rather small number of tracks is sufficient to carry out alignment already in the beginning of the first data taking. TOB rods placed in either of the two Cosmic Racks will offer a good test bench for composite alignment studies to be performed with cosmic data.

The track based alignment relies on the ORCA pattern recognition and track reconstruction.  $\chi^2$  quality tests are applied at ORCA level on the tracks. Rather loose quality tests were used in the very beginning of the alignment. The pattern recognition and track reconstruction was repeated after obtaining first alignment corrections and the  $\chi^2$  quality cut was tightened.

The two outermost rods were kept fixed. This ensured a unique solution to the minimization problem of the track  $\chi^2$ . All layers were used in ORCA track finding, but the track parameters were determined by using only the outermost two reference layers. In spite of using only fixed layers for the track parameters, the iteration over the event sample was necessary, because the sample of tracks used for alignment varies in the course of alignment: the result of the pattern recognition and track quality cut is affected by the corrections to the alignment parameters.

In this note the HIP algorithm is used to align individual detector modules. Modules were aligned in one translational parameter, the local  $x$  coordinate along the direction of measurement of module, and in one rotational parameter, the  $\gamma$  angle, which is the rotation around the beam direction. These are illustrated in Fig. 3.

In the following section we also present results obtained by the Millepede method [6]. Millepede is an algorithm in which not only the individual alignment corrections for each sensor are fitted to the data, but all parameters at once as well as all the track parameters. The challenge related to this method is that it involves solving a matrix

equation with a very large matrix resulting from the linear  $\chi^2$  problem with a very large number of parameters. Several methods exist for solving the matrix equation.

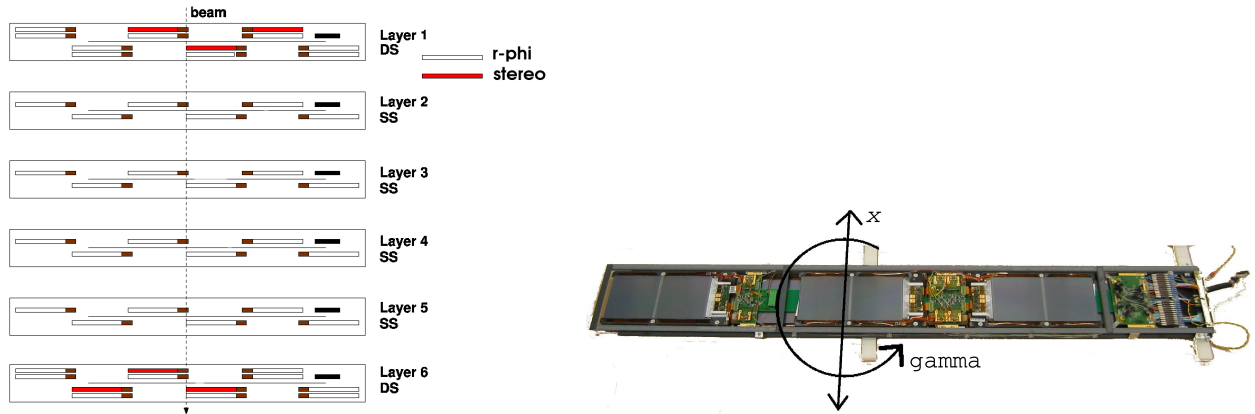

Figure 3: The left picture shows the layout of the TOB Cosmic Rack test structure used for alignment. Rod numbering is equal to layer numbering. Rods capable to hold stereo modules, which both measure  $x$  and  $y$ , are marked with DS (double sided), whereas rods holding modules measuring only one coordinate are marked as SS (single sided). Only three modules in these two DS rods are genuine stereo modules. The right picture shows a rod with the  $x$  coordinate and the  $\gamma$  angle, which were the parameters to be aligned.

## 4 Alignment setup

In September 2004, the TOB Cosmic Rack recorded data in a 120 GeV pion and 70-120 GeV muon beam with a dedicated test setup, comprising 48 silicon strip modules on six TOB rods (Fig. 3). No magnetic field was present, such that particle trajectories are almost straight tracks, only mildly affected by multiple scattering. The beam size was about  $8 \times 5 \text{ mm}^2$  for the pion beam, and the acceptance region for the much larger muon beam was constrained by the trigger scintillator size of about  $10 \times 10 \text{ cm}^2$ . The setup was adjusted with respect to the beam such that the beam hits the overlap region between two adjacent modules (detector 3 and 4 in each rod). The direction of the beam deviated 4 degrees from the normal of the detector modules in the plane perpendicular to the strips. In these alignment studies we used data from a pion run. The angular spread in this beam was well below 0.5 mrad.

In the offline analysis, the first 1000 events were used for noise and pedestal calibration, and then 25000 events were read. Tracks were required to have at least 4 hits. Track seeds were constructed with first and last rods. The nominal momentum of particles was set to 120 GeV, and the magnetic field was set to zero. Since knowledge of the track parameters in both  $x$  and  $y$  is essential, in particular for the alignment of the angle  $\gamma$ , true two-dimensional hits (“matched RecHits”) were required in the first and last rod.

Thus there were 4-6 measurements in the direction measured by the r-phi modules. In the other direction there were 2 measurements provided by the stereo modules.

## 5 Results

As a reference, alignment was first carried out manually with the help of residual plots. For each individual detector module, the position of the peak in the residual plot was located and the module was aligned with a corresponding  $x$  correction. Track reconstruction was repeated and new corrections were defined from the new residual plots, and these iterations were continued as long as the peak positions of the residual plots significantly differed from zero. For simple telescope setups this is a sufficient and straight-forward way to manually align the device in  $x$ . In this study the results of the manual alignment are used as a reference point for the comparison with the more sophisticated track based alignment methods.

Some of the residual plots obtained with the HIP algorithm are shown in Figure 4 as well as the residual distributions with a non-aligned setup. It can be seen that for detector 3, the amount of hits which were found is more than seven times larger when the system is aligned, whereas for detector 4 the amount of hits quadruples with alignment. It can also be seen that with alignment the distributions become more Gaussian. A  $\chi^2 < 15$  cut was used here both for the non-aligned and aligned case.

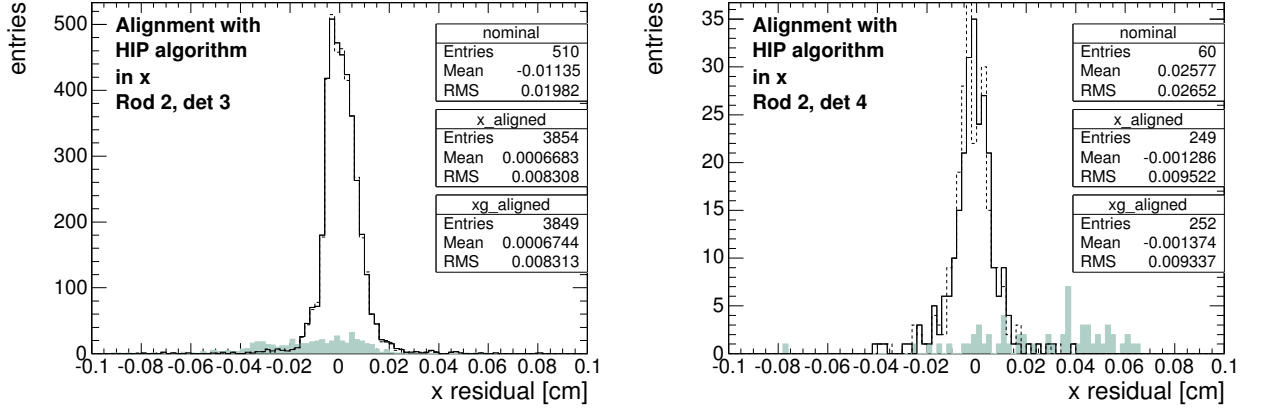

Figure 4: Residuals for the two modules of rod 2 before alignment (shaded color) and after alignment has converged with HIP 1 (solid line) and HIP 2 (dotted line). Residual distributions are very similar in both cases. Detector 4 obtains far less hits than detector 3.

For the alignment of  $x$  only, corrections obtained from the manual procedure can be directly compared to those obtained with the HIP algorithm (“HIP1”) in Table 1. Also the results obtained with the Millepede[6] algorithm are given there.

In addition to the one-dimensional results where only  $x$  was aligned, the HIP algorithm was also used to carry out a simultaneous alignment of both  $x$  and  $\gamma$  (“HIP2”). The center of rotation for the  $\gamma$  angle was in the middle of the sensor, not coinciding with the beam.

Table 1: Alignment Corrections for TOB Cosmic Rack obtained from test beam data. Corrections are for manual alignment in  $x$ , HIP algorithm in  $x$  (HIP 1), Millepede in  $x$ , and for HIP algorithm in both  $x$  and  $\gamma$  (HIP 2). HIP 1 and HIP 2 were carried out with 4000 tracks, and Millepede with carefully selected 500 tracks with six hits each. For each set of corrections the mean  $\chi^2$  values for tracks is presented (a  $\chi^2 < 15$  cut was used). The error estimates are statistical only.

	manual	HIP 1	Millepede	HIP 2		man. - HIP1	man. - Millepede
	$x$ [ $\mu\text{m}$ ]	$x$ [ $\mu\text{m}$ ]	$x$ [ $\mu\text{m}$ ]	$x$ [ $\mu\text{m}$ ]	$\gamma$ [mrad]	$x$ [ $\mu\text{m}$ ]	$x$ [ $\mu\text{m}$ ]
<i>Rod 2</i>							
Det 3	-105 $\pm$ 4	-105 $\pm$ 2	-101 $\pm$ 4	-114 $\pm$ 6	-0.12 $\pm$ 0.08	0 $\pm$ 4	4 $\pm$ 6
Det 4	363 $\pm$ 5	380 $\pm$ 7	379 $\pm$ 17	356 $\pm$ 13	-0.37 $\pm$ 0.18	-17 $\pm$ 9	-16 $\pm$ 18
<i>Rod 3</i>							
Det 3	-454 $\pm$ 4	-466 $\pm$ 2	-457 $\pm$ 4	-466 $\pm$ 6	-0.00 $\pm$ 0.08	12 $\pm$ 4	3 $\pm$ 6
Det 4	-99 $\pm$ 5	-61 $\pm$ 7	-96 $\pm$ 15	-77 $\pm$ 13	-0.26 $\pm$ 0.19	-38 $\pm$ 9	-3 $\pm$ 16
<i>Rod 4</i>							
Det 3	-935 $\pm$ 4	-946 $\pm$ 2	-938 $\pm$ 6	-954 $\pm$ 4	-0.11 $\pm$ 0.06	11 $\pm$ 4	3 $\pm$ 7
Det 4	-579 $\pm$ 4	-541 $\pm$ 6	-544 $\pm$ 16	-532 $\pm$ 9	0.22 $\pm$ 0.14	-38 $\pm$ 8	-35 $\pm$ 17
<i>Rod 5</i>							
Det 3	-457 $\pm$ 4	-470 $\pm$ 2	-467 $\pm$ 4	-479 $\pm$ 4	-0.13 $\pm$ 0.05	13 $\pm$ 4	10 $\pm$ 6
Det 4	-141 $\pm$ 6	-80 $\pm$ 7	-91 $\pm$ 17	-67 $\pm$ 9	0.27 $\pm$ 0.15	-61 $\pm$ 9	-50 $\pm$ 18
mean track $\chi^2$	1.75	1.72	1.73	1.69			

The different track based alignment procedures agree well among themselves and are also compatible with the results of the simple manual alignment both in the sense of individual corrections and of the mean  $\chi^2$  value of the tracks. Due to the special setup for the test beam, detector 4 of the different layers has received approximately only one tenth of the hits of detector 3. Therefore, the statistical uncertainties on the alignment corrections for detector 4 are typically rather large. As a guideline for the statistical uncertainties, Table 1 contains furthermore the error estimates for the algorithms.

The mean track  $\chi^2$  values for the different methods (manual, HIP 1 and Millepede and HIP 2) are close to each other. The manual alignment gives a slightly larger value of 1.75 than other methods. As expected, the two-dimensional alignment converges to the best mean track  $\chi^2$  value of 1.69.

The convergence of the mean  $\chi^2$  values for the tracks for the HIP algorithm with one and two aligned parameters is shown in Figure 5 and 6. A sample of approximately 4000 tracks was used. The  $\chi^2$  values converge fully in 2-3 iterations, and the individual corrections in 3-4 iterations. The oscillations between the two values in Fig. 6 are

results of the fact that the sample of tracks passing the  $\chi^2$  cut oscillates between two sets, as can be seen in Table 2.

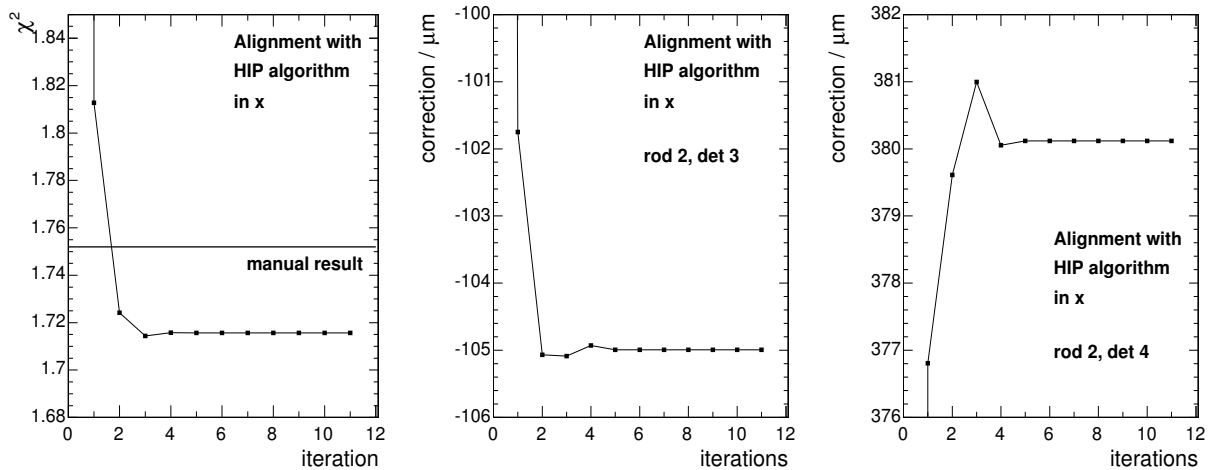

Figure 5: The left plot shows the convergence of the mean  $\chi^2$  value of the test beam data when only  $x$  is aligned. The initial value at iteration zero is not shown. The algorithm converges to a value of 1.72. The manual corrections give a corresponding  $\chi^2$  value of 1.75 (horizontal line). The middle and the rightmost plots show the corresponding convergence of the two modules in rod 2 in  $x$  (initial value 0 not shown).

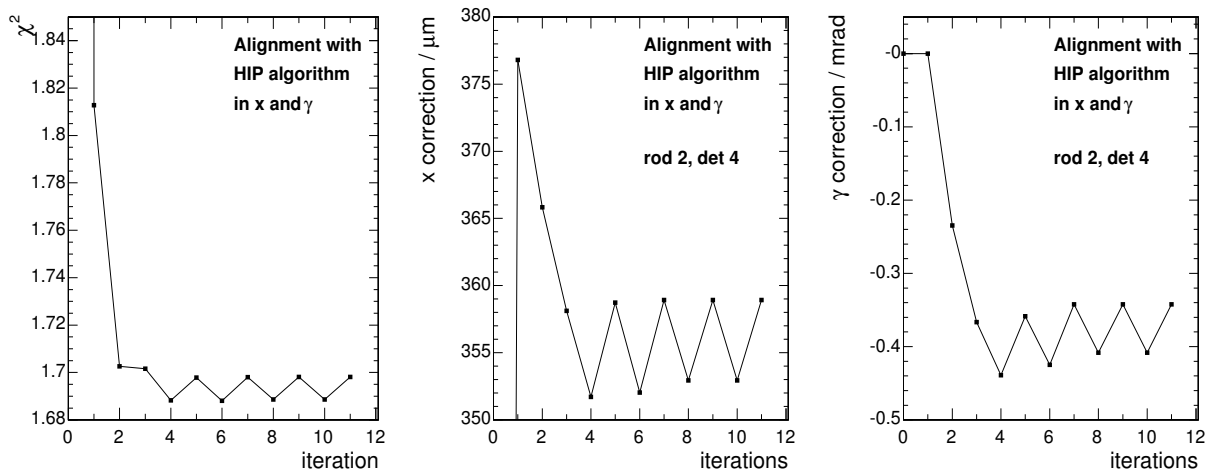

Figure 6: The left plot shows the  $\chi^2$  convergence of the test beam data when  $x$  and  $\gamma$  are aligned simultaneously (with exception that during the first iteration  $\gamma$  is kept fixed). The initial value at iteration zero is not shown. The algorithm converges to a value of 1.69. The plots in the middle and on the right show the corresponding convergence of a particular module in  $x$  and  $\gamma$ , respectively (initial correction of 0 not shown for  $x$ ). Small oscillations caused by changes in the track sample can be seen in all plots.

## 6 Future plans

### 6.1 Development of the HIP algorithm

In these studies we did not try to optimize the performance of the HIP algorithm. It was however noticed that keeping other parameters than  $x$  fixed during the first iteration, and aligning them only after that, improves convergence. Otherwise an oscillating behaviour can be seen in the beginning of alignment. In later studies it would be useful to see if the speed of convergence really depends on this kind of alignment strategy, or if this is case only in the special case of test beam data.

Another parameter which might affect alignment convergence is the  $\chi^2$  cut value used in track reconstruction. With larger values one finds more tracks from an event sample, but their benefit for alignment needs to be checked. There is some evidence from the test beam data that a larger cut (e.g., 50 instead of the standard value of 15) leads to oscillations of some corrections and prevents convergence.

Table 2: Number of tracks and mean  $\chi^2$  value as function of iteration for HIP algorithms. The track  $\chi^2$  cut was set to 100 in the first iteration and to 15 in the following iterations.

Iteration	$\chi^2$ cut	HIP 1			HIP 2		
		aligned	tracks found	mean $\chi^2$	aligned	tracks found	mean $\chi^2$
1	100	<i>x</i>	815	60.9162	<i>x</i>	815	60.91620
2	15	<i>x</i>	4050	1.81277	<i>x, <math>\gamma</math></i>	4050	1.81277
3	15	<i>x</i>	4114	1.72420	<i>x, <math>\gamma</math></i>	4109	1.70259
4	15	<i>x</i>	4114	1.71438	<i>x, <math>\gamma</math></i>	4113	1.70162
5	15	<i>x</i>	4116	1.71576	<i>x, <math>\gamma</math></i>	4113	1.68826
6	15	<i>x</i>	4116	1.71572	<i>x, <math>\gamma</math></i>	4112	1.69784
7	15	<i>x</i>	4116	1.71572	<i>x, <math>\gamma</math></i>	4114	1.68804
8	15	<i>x</i>	4116	1.71572	<i>x, <math>\gamma</math></i>	4113	1.69800
9	15	<i>x</i>	4116	1.71572	<i>x, <math>\gamma</math></i>	4115	1.68858
10	15	<i>x</i>	4116	1.71572	<i>x, <math>\gamma</math></i>	4113	1.69811
11	15	<i>x</i>	4116	1.71572	<i>x, <math>\gamma</math></i>	4115	1.68858
12	15	<i>x</i>	4116	1.71572	<i>x, <math>\gamma</math></i>	4113	1.69811
13	15	<i>x</i>	4116	1.71572	<i>x, <math>\gamma</math></i>	4115	1.68858
14	15	<i>x</i>	4116	1.71572	<i>x, <math>\gamma</math></i>	4113	1.69811
15	15	<i>x</i>	4116	1.71572	<i>x, <math>\gamma</math></i>	4115	1.68858

The use of different  $\chi^2$  cuts can be avoided in future studies by using individual alignment position errors (APE) for each sensor. With this approach one can also take into account that some sensors can be aligned better than others (i.e., those with far less hits).

In later studies also information like the number of hits and tracks needed for alignment of different parameters would be of interest.

The HIP algorithm will be applied to the CMS geometry. Simulated events will be used to study various alignment issues. Results of first this kind of study are presented in [5].

## 6.2 Cosmic data and verification of rod survey measurements

There exist some cosmic data recorded with the FinnCRack DAQ installation and the CERN TOB CRack. Alignment studies with these data will be an interesting next step, since larger variations in both angles and positions of the tracks make the data sensitive to more than two alignment parameters.

It is foreseen in the near future that a fully equipped TOB CRack as well as the FinnCRack will carry out large cosmic data runs. The accumulated data statistic can not only be used to further scrutinize the track based alignment procedures but also to cross check the rod survey measurements performed in Helsinki. In these measurements the exact coordinates of the positioning pins and supports of the detector modules are measured for all 753 TOB rods with a Zeiss 3D contact coordinate measurement device. The measurement accuracy of the device was better than  $10 \mu\text{m}$ , and the measurement setup accuracy was estimated to be better than  $25 \mu\text{m}$  for the pins and better than  $30 \mu\text{m}$  for the supports. Based on these measurements alignment corrections to the ideal positions could be determined. Typical distribution of these measurement can be seen in Figs. 7 and 8. The sensor positions obtained in this way are supposed to form the first real reconstruction geometry of the TOB. The intrinsic uncertainty of these new position values should be only  $30 \mu\text{m}$  (see e.g., RMS in Fig. 7) and, therefore, would lead to excellent initial alignment uncertainties for the TOB at the startup. However, systematic uncertainties of these survey measurements can be potentially large. Also the uncertainties within a module related to the distance between the positioning pins on the rod and the strips have not been taken into account here. Track based alignment procedures could be used to cross check these measurements and in turn determine their systematic uncertainties. For that reason the alignment studies described in this note not only serve as a validation procedure for the general track based alignment concept of the CMS tracker but also exhibit the very practical potential to scrutinize the important survey measurements of TOB rods carried out in Helsinki.

## 7 Summary

In this note we have presented first results on the alignment of a small-scale test setup with test beam data. The track reconstruction and the alignment procedure have been carried out within a software framework that is, besides minor modifications due to the different geometry setups, identical to the official CMS reconstruction environment. The results demonstrate that the recently implemented alignment software such as the alignment tools, alignment interface and HIP alignment algorithm function properly in this small testbed. It also represents the first application of a track based alignment procedure on real CMS data. Furthermore this setup provides now the unique opportunity to cross check the important placement measurements of sensors on TOB rods with cosmic muon data.



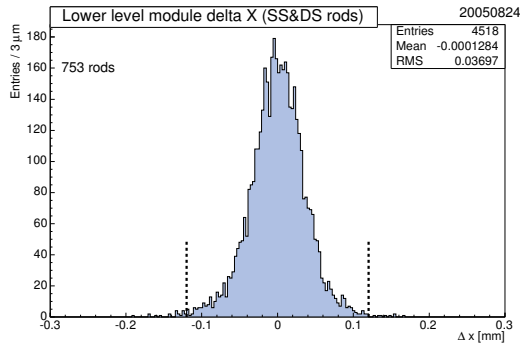

Figure 7: Deviations for modules in the x-direction from the rod measurements at Helsinki. Limits differentiating excellent and acceptable values are shown with dashed lines. The rejection limit was  $\pm 0.4$  mm.

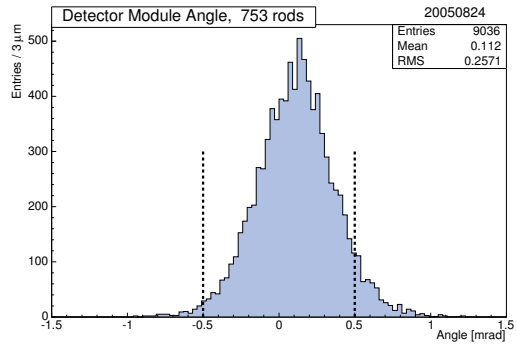

Figure 8: Angular deviations corresponding to the  $\gamma$  angle. Limits differentiating excellent and acceptable values are shown with dashed lines. The rejection limit was  $\pm 1.5$  mrad.

## Acknowledgements

We thank Martin Weber, Alexander Dierlamm and the TOB Cosmic Rack group for useful information concerning the Cosmic Rack, Ivan Reid and Teppo Mäenpää for contributions to the general Cosmic Rack software, Markus Stoye for the Millepede results, and Wolfgang Adam, Frank-Peter Schilling and Teddy Todorov for various ORCA-related issues.

## References

- [1] I. Belotelov, O. Buchmüller, I. González Caballero, A. Heister, T. Lampén, P. Martínez, C. Martínez-Rivero, F. Matorras, M. Thomas, V. Valuev, *Simulation of Misalignment Scenarios for CMS Tracking Devices*, CMS Note in preparation.
- [2] A. Khanov et al., *Tracking in CMS: software framework and tracker performance*, Nucl. Instrum. and Methods A **478(1-2)** (2002), 460-464.
- [3] J.-L. Agram et al., *The Silicon Sensors for the Compact Muon Solenoid Tracker - Design and Qualification Procedure*, CMS NOTE **2003/015**.
- [4] V. Karimäki, A. Heikkinen, T. Lampén, and T. Lindén, *Sensor alignment by tracks*, CMS CR **2003/022**, presented in CHEP03, La Jolla.
- [5] V. Karimäki, T. Lampén, and F.-P. Schilling, *The HIP Algorithm for Track Based Alignment and its Application to the CMS Pixel Detector*, CMS Note in preparation.
- [6] P. Schleper, G. Steinbrück, M. Stoye, *Software Alignment of the CMS Tracker using MILLEPEDE II*, CMS Note in preparation.