

HELSINKI UNIVERSITY OF TECHNOLOGY  
Faculty of Electronics, Communications and Automation  
Department of Communications and Networking

Jani Koskinen

# Dimensioning and Optimizing Mobile Networks with Performance Management System

Thesis submitted as the partial fulfilment of the requirements for the degree of Master of Science in Technology.

Espoo, April 28, 2008

Supervisor: Professor Raimo Kantola  
Instructor: Timo Varila, M.Sc.(Tech.)

<b>Author:</b>	Jani Koskinen	
<b>Name of the Thesis:</b>	Dimensioning and Optimizing Mobile Networks with Performance Management System	
<b>Date:</b>	April 28, 2008	<b>Pages:</b> 9 + 88
<b>Faculty:</b>	Electronics, Communications and Automation	
<b>Department:</b>	Communications and Networking	
<b>Supervisor:</b>	Professor Raimo Kantola	
<b>Instructor:</b>	Timo Varila, M.Sc.(Tech.)	
<p>The purpose of this master's thesis was to investigate the dimensioning and optimizing of the mobile networks with a performance management system. The thesis discusses at the general level the most important radio technologies, their requirements and different services they provide. The radio technologies studied are GSM, GPRS, EDGE, UTMS, HSPA, and the next generation technologies. Additionally, the most important access transport technologies have been discussed; including TDM, ATM, Ethernet, IP and MPLS, and their abilities to deliver quality of service and what operation and maintenance methods they provide.</p> <p>Performance management system is a major component in the network management process, along with fault management and other OAM methods. Various performance indicators can be calculated from the performance queries, and they can be used for the needs of network management. The thesis examines in particular, what kind of performance measurements should be done in the access networks, focusing on what network segments receive the most benefit from it. Also, the thesis studies the implementation of different performance management systems integration, as it is often needed in multi vendor hierarchical networks.</p> <p>The use of performance management systems in access networks is sorted with the dimensioning and optimizing process to discover, what kind of dimensioning and optimizing solutions would fit in the access networks. Unfortunately, there are relatively few solutions in the thesis, because operators have not yet implemented any such methods. To this date, simply adding more capacity has been enough for operators. However, combined with new and faster radio technologies it will no longer be sufficient anymore. Hopefully, in the future we will see highly sophisticated dimensioning and optimizing solutions built into performance management systems.</p>		
<b>Keywords:</b> Performance management, network management, OAM, dimensioning, optimizing, mobile network, access network, QoS		

<b>Tekijä:</b>	Jani Koskinen	
<b>Työn nimi:</b>	Mobiiliverkkojen mitoitus ja optimointi suorituskyvyn hallintajärjestelmän avulla	
<b>Päivämäärä:</b>	28. huhtikuuta 2008	<b>Sivumäärä:</b> 9 + 88
<b>Tiedekunta:</b>	Elektroniikan, tietoliikenteen ja automaation tiedekunta	
<b>Laitos:</b>	Tietoliikenne- ja tietoverkkotekniikan laitos	
<b>Työn valvoja:</b>	Professori Raimo Kantola	
<b>Työn ohjaaja:</b>	DI Timo Varila	
<p>Tämän diplomityön tarkoituksena oli tutkia suorituskyvyn hallintajärjestelmän käyttöä mobiiliverkkojen mitoituksen ja optimoinnin apuna. Työssä käydään suurpiirteisesti läpi tärkeimmät radioteknologiat ja niiden vaatimukset, sekä erilaiset palvelut, joita ne mahdollistavat. Käsiteltäviä radioteknologioita ovat GSM, GRPS, EDGE, UMTS, HSPA ja pintaa raapaistaan myös seuraavan sukupolven radioteknologioiden ympäriltä. Lisäksi käydään läpi tärkeimmät liityntäverkon siirtoteknologit, eli TDM, ATM, Ethernet, IP ja MPLS, ja selvitetään, miten niissä voidaan välittää palvelunlaatua sekä mitä käyttö- ja kunnossapitomenetelmiä ne mahdollistavat.</p> <p>Itse suorituskyvyn hallinta liittyy olennaisena osana verkonhallintaprosessiin virheen hallinnan sekä muiden OAM-menetelmien ohella. Suorituskykykyselyiden tuloksena voidaan laskea erilaisia suorituskykyindikaattoreita, joita voidaan käyttää erilaisiin verkonhallinnan tarpeisiin. Työssä tutkitaan erityisesti, millaisia suorituskykymittauksia liityntäverkoissa kannattaisi tehdä ja etenkin missä verkon osissa niistä voisi olla hyötyä. Työssä käydään läpi myös erilaisten suorituskyvyn hallintajärjestelmien integraatiota, jota monitasoisissa usean valmistajan verkoissa usein saatetaan tarvita.</p> <p>Itse mitoitus- ja optimointiprosessin yhteydessä selvitetään nimenomaan suorituskyvyn hallintajärjestelmän käyttöä liityntäverkoissa. Samalla selvitetään, mitkä mitoitus- ja optimointiratkaisut saattaisivat sopia liityntäverkkoihin. Valitettavasti työssä esitetään erilaisia mitoitus- ja optimointimenetelmiä varsin suppeasti. Tähän on suurimpana syynä se, ettei operaattorien keskuudessa olla menetelmiä juurikaan käytetty. Näihin päiviin asti operaattoreille on riittänyt pelkästään kapasiteetin lisääminen, mutta uusien ja nopeampien radioteknologioiden myötä se ei tule enää riittämään. Toivottavasti tulevaisuudessa tulemmekin näkemään pitkälle kehittyneitä mitoitus- ja optimointiratkaisuja pitkälle kehittyneiden verkon- ja suorituskyvynhallintajärjestelmien ohella.</p>		
<b>Avainsanat:</b>	Suorituskyvyn hallinta, verkon hallinta, käyttö- ja kunnossapito, mitoitus, optimointi, mobiiliverkko, liityntäverkko, palvelunlaatu	

## Acknowledgements

This thesis was made for Tellabs on their Espoo premises. As I was interested in the field of product management, the opportunity to write a thesis on this topic was a great luck. It also provided a great challenge since the topic was not related to my other main duties in the company.

First of all I wish to thank Tellabs, in particular my manager, Juha Mailisto, for this opportunity, and my other co-workers in the system testing group for their understanding and patience while I have been distracted with my work.

Most of the time the thesis work was interesting for me. I enjoyed investigating future mobile technologies which really showed the direction the telecommunications industry is heading for in the near future. It was very challenging to find information about the latest developments in the field.

The greatest thanks of course belong to my instructor, Timo Varila, for his good guidance and the background information he gave during the whole thesis.

Further thanks go to Professor Raimo Kantola, who supervised my thesis work. He was a great support for me, especially when I was uncertain of the scope and contents of the thesis.

Additional thanks belong to William Martin. I truly appreciate his work and effort for correcting the language of this thesis.

Finally, special thanks go to my dear Elisa for supporting me at home, but also for keeping me on track.

Espoo, April 28, 2008

Jani Koskinen

# Table of Contents

Acknowledgements .....	IV
Table of Contents .....	V
Abbreviations .....	VII
1 Introduction .....	1
1.1 Background.....	1
1.2 Research problem and motivation .....	1
1.3 Objectives and scope .....	2
1.4 Structure of the thesis .....	2
2 Mobile networks.....	5
2.1 Radio networks.....	6
2.1.1 GSM .....	7
2.1.2 GPRS and EDGE.....	7
2.1.3 UMTS and HSPA.....	8
2.1.4 Next generation wireless technologies .....	9
2.2 Mobile services.....	10
2.2.1 Service diversity .....	11
2.2.2 Service classes in the mobile networks .....	12
2.2.3 Quality of the end-user Experience .....	14
3 Mobile access networks.....	16
3.1 Overview .....	16
3.2 Mobile transmission network technologies .....	18
3.2.1 TDM .....	20
3.2.2 Ethernet.....	21
3.2.3 ATM .....	24
3.2.4 IP.....	29
3.2.5 MPLS.....	30
3.3 Access network technology interworking .....	33
4 Network monitoring tools.....	36
4.1 Operation and maintenance .....	36
4.2 Performance management .....	37
4.2.1 Monitoring the performance in the networks .....	38
4.2.2 Performance indicators .....	40
4.2.3 Performance data processing.....	43
4.2.4 Benefits from the performance management.....	44
4.3 Fault management .....	46
4.4 The connectivity test.....	47
4.5 Network monitoring process .....	48
5 Tellabs 8000 Network Manager Performance Management Package.....	50
5.1 Overview .....	50
5.2 Features.....	50
5.3 Collecting and processing data .....	51
5.4 Example measurements .....	53

5.5	Improvements in the near future.....	54
6	Performance management tool integration.....	56
6.1	Tool integration process .....	56
6.2	Various performance management tools .....	58
6.2.1	Summarizing the performance management tools .....	61
7	Dimensioning and optimizing the access networks.....	63
7.1	Dimensioning and optimizing telecommunications networks.....	63
7.2	Performance management in radio access networks .....	64
7.2.1	Network monitoring requirements .....	65
7.2.2	Performance tool requirements.....	66
7.2.3	Using Tellabs 8000 PMS in the access networks.....	67
7.2.4	Investment management.....	68
7.3	Radio network traffic balancing .....	69
7.4	Other transport solutions .....	70
7.5	Traffic engineering .....	71
7.5.1	QoS differentiation .....	71
7.5.2	Capacity reservation on the physical links .....	72
7.5.3	Other traffic engineering methods.....	72
7.6	Other dimensioning and optimizing solutions.....	73
8	Summary and conclusions .....	74
8.1	Summary of the thesis .....	74
8.2	Conclusions .....	75
8.3	Recommendations for further study .....	76
	References .....	78
	Appendix A .....	85
	Appendix B.....	87

## Abbreviations

<b>3G</b>	<b>Third generation mobile phone standard and technology</b>
<b>3GPP</b>	<b>3rd Generation Partnership Project</b>
<b>3GPP2</b>	<b>The Third Generation Partnership Project 2</b>
<b>4G</b>	<b>Fourth generation mobile phone standard and technology</b>
<b>64-QAM</b>	<b>64-State Quadrature Amplitude Modulation</b>
<b>AAL2</b>	<b>ATM Adaptation Layer 2</b>
<b>AAL5</b>	<b>ATM Adaptation Layer 5</b>
<b>ANSI</b>	<b>American National Standards Institute</b>
<b>ATM</b>	<b>Asynchronous Transfer Mode</b>
<b>BMI</b>	<b>Buffered Message Interface</b>
<b>BTS</b>	<b>Base Transceiver Station</b>
<b>BSC</b>	<b>Base Station Controller</b>
<b>CDMA</b>	<b>Code Division Multiple Access</b>
<b>CDMA2000</b>	<b>2.5<sup>th</sup> and 3<sup>rd</sup> generation mobile standard</b>
<b>CORBA</b>	<b>Common Object Request Broker Architecture</b>
<b>CS</b>	<b>Circuit Switching</b>
<b>CSV</b>	<b>Comma-separated values</b>
<b>D-AMPS</b>	<b>Digital-Advanced Mobile Phone System</b>
<b>DSCP</b>	<b>Differentiated Services Code Point</b>
<b>DSL</b>	<b>Digital Subscriber Line / Loop</b>
<b>E1</b>	<b>E-carrier level 1</b>
<b>E-GPRS</b>	<b>Enhanced GPRS, EDGE</b>
<b>EDGE</b>	<b>Enhanced Data rates for Global Evolution</b>
<b>ETSI</b>	<b>European Telecommunications Standards Institute</b>
<b>EV-DO</b>	<b>Evolution-Data Optimized</b>
<b>F4</b>	<b>ATM virtual path level maintenance flow</b>
<b>F5</b>	<b>ATM virtual channel level maintenance flow</b>
<b>GGSN</b>	<b>Gateway GPRS Support Node</b>
<b>GPRS</b>	<b>General Packet Radio Service</b>
<b>GSM</b>	<b>Global System for Mobile communications</b>
<b>HSDPA</b>	<b>High-Speed Downlink Packet Access</b>

<b>HSPA</b>	<b>High-Speed Packet Access</b>
<b>HSUPA</b>	<b>High-Speed Uplink Packet Access</b>
<b>IEEE</b>	<b>Institute of Electrical and Electronics Engineers</b>
<b>IETF</b>	<b>Internet Engineering Task Force</b>
<b>IMA</b>	<b>Inverse Multiplexing for ATM</b>
<b>IP</b>	<b>Internet Protocol</b>
<b>IS-95</b>	<b>Interim Standard 95, 2G mobile standard</b>
<b>ITU-T</b>	<b>International Telecommunications Union – Telecommunication Standardization Sector</b>
<b>Iu</b>	<b>Open interface connecting UTRAN to core network</b>
<b>Iub</b>	<b>Interface between the RNC and Node B in UMTS network</b>
<b>Iu-CS</b>	<b>Circuit switched part of Iu interface, between RNC and MSC</b>
<b>Iu-PS</b>	<b>Packet switched part of Iu interface, between RNC and SGSN</b>
<b>KPI</b>	<b>Key Performance Indicator</b>
<b>LAN</b>	<b>Local Area Network</b>
<b>LSP</b>	<b>Label Switched Path</b>
<b>LTE</b>	<b>Long Term Evolution</b>
<b>ME</b>	<b>Maintenance Entity</b>
<b>MEG</b>	<b>Maintenance Entity Group</b>
<b>MEP</b>	<b>Maintenance Entity Group End Point</b>
<b>MIB</b>	<b>Management Information Base</b>
<b>MPLS</b>	<b>Multiprotocol Label Switching</b>
<b>MSC</b>	<b>Mobile Switching Center</b>
<b>MGw</b>	<b>Media Gateway</b>
<b>NBIF</b>	<b>North Bound Interface</b>
<b>OAM</b>	<b>Operations and Maintenance</b>
<b>OSI</b>	<b>Open Systems Interconnection</b>
<b>PDH</b>	<b>Plesiochronous Digital Hierarchy</b>
<b>PM</b>	<b>Performance Management</b>
<b>PMS</b>	<b>Performance Management System</b>
<b>PoS</b>	<b>Packet over SONET/SDH</b>
<b>PPP</b>	<b>Point-to-Point Protocol</b>
<b>PS</b>	<b>Packet Switching</b>
<b>PSTN</b>	<b>Public Switched Telephone Network</b>



<b>QoE</b>	<b>Quality of the end-user Experience</b>
<b>QoS</b>	<b>Quality of Service</b>
<b>QPSK</b>	<b>Quadrature Phase-Shift Keying</b>
<b>RAN</b>	<b>Radio Access Network</b>
<b>RFC</b>	<b>Request For Comments</b>
<b>RNC</b>	<b>Radio Network Controller</b>
<b>RNL</b>	<b>Radio Network Layer</b>
<b>RNS</b>	<b>Radio Network Subsystem</b>
<b>RSVP-TE</b>	<b>Resource Reservation Protocol – Traffic Engineering</b>
<b>SDH</b>	<b>Synchronous Digital Hierarchy</b>
<b>SGSN</b>	<b>Serving GPRS Support Node</b>
<b>SLA</b>	<b>Service Level Agreement</b>
<b>SNMP</b>	<b>Simple Network Management Protocol</b>
<b>SONET</b>	<b>Synchronous Optical Network</b>
<b>STM</b>	<b>Synchronous Transfer Mode</b>
<b>STS</b>	<b>Synchronous Transport Signal</b>
<b>T1</b>	<b>T-carrier level 1</b>
<b>TE</b>	<b>Traffic Engineering</b>
<b>TCP</b>	<b>Transmission Control Protocol</b>
<b>TDM</b>	<b>Time Division Multiplexing</b>
<b>TNL</b>	<b>Transport Network Layer</b>
<b>TRAU</b>	<b>Transcoder and Rate Adaptation Unit</b>
<b>UMB</b>	<b>Ultra Mobile Broadband</b>
<b>UMTS</b>	<b>Universal Mobile Telephone System</b>
<b>UTRAN</b>	<b>Universal Terrestrial Radio Access Network</b>
<b>VLAN</b>	<b>Virtual Local Area Network</b>
<b>VC</b>	<b>Virtual Channel</b>
<b>VoIP</b>	<b>Voice over Internet Protocol</b>
<b>VP</b>	<b>Virtual Path</b>
<b>W-CDMA</b>	<b>Wideband Code Division Multiple Access</b>
<b>WAN</b>	<b>Wide Area Network</b>
<b>WiMAX</b>	<b>Worldwide Interoperability for Microwave Access</b>
<b>WWW</b>	<b>World Wide Web</b>
<b>XML</b>	<b>Extensible Markup Language</b>

# **1 Introduction**

## **1.1 Background**

Mobile access transport networks have traditionally been based on the PDH and SDH architectures. As a result of the mobile radio technology development, the bandwidth in the mobile devices is constantly increasing leading to more data traffic also to the access network. For example, using HSPA technology with flat rate pricing instead of E-GPRS technology with usage based pricing, the data traffic amount can be multiplied many times in the transport network. That is because of HSPA's higher bandwidth requirements and because the downloaded or uploaded bytes do not have any extra cost. Circuit switched connections are not cost effective, and therefore the recent trend has been a move towards packet switched technologies. The most common packet switched technology in the mobile access networks is Ethernet. Also, in the migration process from circuit switched networks to the packet switched networks, the IP/MPLS over Ethernet has been a popular and potential choice of architecture [MOM07]. The MPLS makes it possible to encapsulate other different transport technologies over it, for example, TDM, ATM, Ethernet, IP and Frame Relay. Therefore, MPLS is quite flexible if older transport technologies have to be used because of the access network specifications.

Radio access networks, therefore, have multiple different technologies and the data traffic is constantly rising. With these problems in mind, the use of performance management has received interest with other operation and maintenance tools to help with the access network dimensioning and optimizing.

## **1.2 Research problem and motivation**

There are two major research problems to be solved. The first one is defining usage of performance management in the access networks. The second one is developing good dimensioning and optimizing methods for these access networks based on performance measurements. These two problems will be studied in this thesis.

Due to the rapid development of mobile architecture, the bandwidth of mobile devices is ever increasing. The bandwidth increase causes more data traffic not only to the mobile radio networks, but also to the mobile access networks. As the access transport networks are using different transport technologies and architectures, the major increase of the traffic has been problematic. Previously the problem has been solved by simply increasing capacity. Today however, by using sophisticated OAM methods, especially performance management with some dimensioning and optimizing methods, the traffic load can be better balanced in the access transport networks. In other words, the operators have a need to develop performance management as an important means of managing the investment in their networks.

### **1.3 Objectives and scope**

The thesis has two goals: one is to provide a good overview of the mobile transport networks and how the technologies in those transport networks can provide operations and maintenance functions for performance management. In particular, the quality of service mechanisms and capabilities are studied.

The other goal is to examine performance management and the process of managing access networks. There will be a study how it can be improved to get more help in the designing and optimizing of mobile access transport networks. In the performance management study field, the focus will be on performance management of the radio access transport networks. We will study the possible benefits available in different performance management systems integration.

### **1.4 Structure of the thesis**

The second chapter of the thesis offers a brief overview of mobile networks. The overview will be brief at the radio network level since the next chapter will concentrate on the transport level. This comparison includes the different services that are used in the mobile networks. The comparison will be made in terms of the traffic and quality of service levels using the specifications of required bandwidths, delays and delay

variations. In order to do this, consideration of the evolution of the mobile network technologies and protocol stacks is necessary.

In the third chapter the different transport network technologies and architectures are examined, focusing on the technologies in the access transport networks. The quality of service and operation and maintenance functions of the technologies will be discussed in greater detail. Moreover, the prerequisites of transport networks needed by the radio networks to manage the traffic requirements and needs are discussed.

The fourth chapter provides an overview about operations and maintenance and it focuses on the concept of performance management. The chapter studies the division between the operation and maintenance tools that include: performance management, connectivity testing and fault management. The main focus will be on performance monitoring, but also the performance monitoring process and the whole concept of network management will be examined. The theories of the second, the third and the fourth parts will be based on various books, publications and specifications on mobile networks.

The fifth chapter contains an overview of Tellabs 8000 Network Manager Performance Management Package and how the performance management has been implemented and studies how it should be improved. The improvements should be both realistic and feasible, the main question being what things in mobile networks should be measured and analyzed. In the course of this investigation, the performance management process with the Tellabs tool will be discussed and some experimental measurements are made.

The sixth chapter discusses the integration of the performance management tools. It discusses the benefits and disadvantages of integrating the various tools. The chapter summarizes and analyses numerous commercial performance management tools available on the markets by different vendors.

Presented in Chapter 7 is a discussion of how the mobile access networks should be designed and their traffic balanced based on the performance measurements. One challenge to be handled is at what levels the balancing should take place. It is also necessary to study, what options there really are to balance the traffic and is the whole process worth of financial costs. The facts, proposals and conclusions in the sixth and the seventh chapters will be based on interviews of people working on performance management and network operator fields, but also on the research conclusions drawn during the thesis work.

## 2 Mobile networks

For the last several years, the evolution of radio network technologies has been very rapid. Nowadays, there are multiple different kinds of radio network technologies used even within the same geographical area. The most common thing for all the latest technologies is that they all support packet switched data services. The circuit switched voice services are no longer the dominating service.

The present trend is that the different radio technologies are smoothly converging towards 3G, 4G and beyond [BAN04]. In this section some of the most commonly used radio technologies are compared. The most important services are examined, focusing on especially the needs of the services for the transport layer.

According to Wireless Intelligence [WIR07], there were almost 3 billion wireless subscribers in the first quarter of 2007. The subscribers can be divided into the different technologies in Table 1.

Table 1. Wireless subscribers in Q1 2007.

<b>World</b>	<b>2,831,345,390</b>	
GSM	2,278,095,380	80.5%
3GSM (WCDMA)	114,664,827	4.0%
CDMA	18,138,942	0.6%
CDMA 1X	289,963,166	10.2%
CDMA 1X EV-DO	57,376,347	2.0%
TDMA	16,235,932	0.6%
PDC	27,857,370	1.0%
iDEN	26,494,743	0.9%
Analog	2,518,683	0.1%

As we can see from Table 1, the majority of all subscribers are still on the GSM technology, as the WCDMA technology, that includes UMTS, is only 1/20 of that.

When referenced to Figure 1, however, we can see that the speech and data (packet) traffic amounts are almost the same in the world average per RNC.

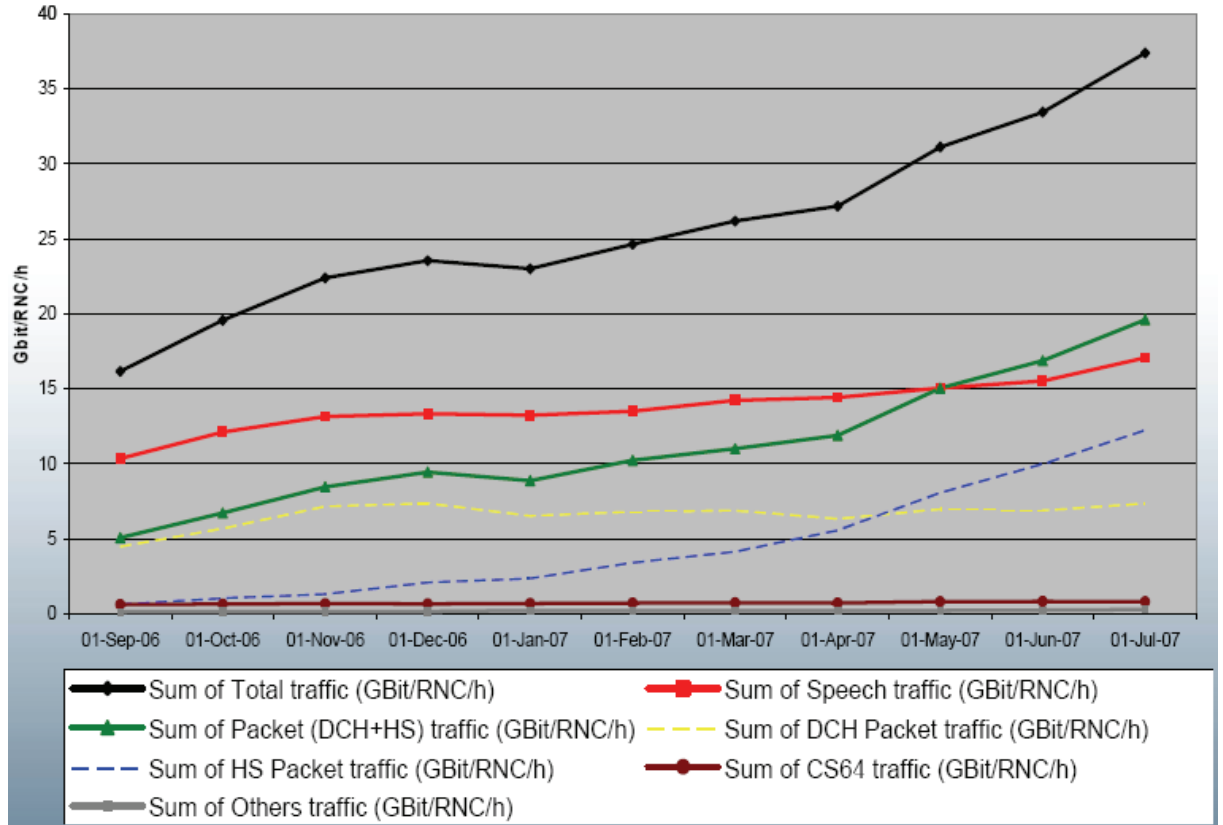

Figure 1. World average traffic volume per RNC [ERI07].

For the future, the UMTS forum has forecast that the wireless capacity requirements in Western Europe will grow from 250 Terabytes per day to 5750 Terabytes per day over the next 10 years [BRO07a]. Unfortunately, the current 3G systems will not scale cost effectively to meet this demand, so there is a need to deploy the roadmap for the next generation candidate technology. The leading candidate is called 3GPP Long-Term Evolution, which introduces an entirely new radio interface.

## 2.1 Radio networks

As we learnt from Table 1, there are multiple mobile technologies that are used in the world. The following sections will include brief descriptions about GSM, GPRS and

EDGE, UMTS and HSPA, and also some words about the next generation mobile technologies. The radio technologies and the radio interfaces are not discussed at all, only the main properties and requirements for the access and transport networks. These include the bandwidths delay and jitter.

### 2.1.1 GSM

GSM is standardized by ETSI and operates on three principal frequency regions, which are 900 MHz, 1800 MHz and 1900 MHz [BAN04]. It is often also referred as the 2<sup>nd</sup> generation mobile technology. One channel from the mobile station to the base transceiver station, base station controller and all the way to the transcoding and rate adaptation unit (TRAU) is 16 kbit/s. From TRAU to MSC and to PSTN, the speech is converted to standard 64 kbit/s. In the radio interface, between the mobile station and the base transceiver station, one 16 kbit/s channel can be used for either 13 kbit/s speech or 14.4 or 9.6 kbit/s data. The overhead is for channel signalling purposes. The process is illustrated in Figure 2, which shows the bandwidths in the access network.



Figure 2. GSM transcoding transfer rates.

The speech or data calls are transported over E1 or T1 links using the TDM structure. These links connect BTSs to BSCs and BSCs through TRAU to the MSC. Since the traffic is sent over the circuit switched network, the characteristics for the traffic are low delay and fixed bandwidth.

### 2.1.2 GPRS and EDGE

GPRS is a general packet radio service that allows sending and receiving of traffic that is in a packet form, across the GSM network. It was originally specified by ETSI, but later was moved to 3GPP. The GPRS architecture uses the existing GSM architecture,



but two new network elements must be added into the access network. The first, SGSN, is connected to BSC and MSC and the second, GGSN, is between SGSN and the core network, mostly Internet. The interface Gb, that is between BSC and SGSN, is specified to use the Frame Relay transport protocol. The Gn interface, which is between SGSN and GGSN, uses IP routing [BAN04].

The basic idea of GPRS is to share some common air channels for multiple users. So in theory, one user can obtain more than one channel to multiply the used bandwidths. However, GPRS transport speeds are also dependant on the channel encoding, so by using the most efficient coding with the maximum number of eight air channels, the total maximum bandwidth for GPRS in theory is  $8 * 21.4 \text{ kbit/s} = 171.2 \text{ kbit/s}$ . Since the GPRS technology added packet switched data services to the mobile networks, some quality of service capabilities were also specified. These issues will be discussed in greater detail in the next sections.

EDGE is also often referred as enhanced GPRS. It is quite similar to GPRS, but it uses different modulation and coding schemes. With eight timeslots, the maximum bandwidth of EDGE is in theory  $8 * 59.2 \text{ kbit/s} = 473.6 \text{ kbit/s}$ . But in practise, however, usually no more than four timeslots are in use, making the maximum bandwidth to be  $236.8 \text{ kbit/s}$ . The newer EDGE releases have also introduced different access network architecture, called GSM/EDGE radio access network (GERAN). It is closely aligned with UTRAN and is designed to give better QoS than the older systems. The transport technology in GERAN was specified to be ATM.

Since the GPRS and EDGE technologies are packet switched over the existing GSM network, the bandwidth is usually fixed and delay is accurate. This makes the requirements for the transport in the access network slightly more demanding than those in the GSM case.

### **2.1.3 UMTS and HSPA**

UMTS is a 3G technology specified by 3GPP and the first deployment was 3GPP release 99. The major change with regards to earlier GSM and EGPRS networks was in

the radio interface with the introduction of code division multiple access (CDMA) [BAN04]. The UMTS radio access network architecture is similar to GSM and E-GPRS radio access networks having the same network components: MSC, SGSN and GGSN. However, 3GPP renamed the Base Transceiver Station (BTS) as Node B and the Base Station Controller (BSC) to the Radio Network Controller (RNC). In Release 4, the MSC was split to the Media Gateway (MGw) and the MSC-server. A good overview picture with 3GPP network components and interfaces can be seen in Figure 3 contained in the next chapter. The peak transfer rate with UMTS technology (without HSPA) can be up to 384 kbit/s [SOL06]. Also, the latencies in UMTS services can be much less than with earlier GSM and E-GPRS technologies.

The term HSPA contains two technologies: high-speed downlink packet access (HSDPA) and high-speed uplink packet access (HSUPA).

HSDPA relies on a new transport channel that is assigned for a single user during a certain time interval in a time- and/or code-multiplexed manner [SOL06]. It was introduced in 3GPP Release 5. When compared to the basic WCDMA technology, HSDPA includes some enhanced multi-code operations. Some features, however, from the basic WCDMA technology have been excluded: fast power control, variable spreading factor and the soft handover. Soft handover is the one excluded feature that makes the HSDPA interesting with regards to performance manners, due to the difficulty of the load balancing.

HSUPA is an improvement introduced in 3GPP Release 6 for uplink packet data transfer. HSUPA does not change the uplink modulation, but rather improves the efficiency of the radio link which increases the packet data throughput. Theoretical peak rates for HSDPA are 14 Mbit/s and for HSUPA 5 Mbit/s [BRO07a].

#### **2.1.4 Next generation wireless technologies**

As the capacity limits from HSPA and EV-DO networks will soon be reached, there are several proposals for the next generation of wireless technologies, also called the 4G technologies. The leading candidates at the moment are: Evolved HSPA, Long-Term Evolution, WiMAX and Ultra Mobile Broadband [BRO07a]. These technologies are

quite different in that they use different spectrum and bandwidth, and different multiple access and duplex methods. Only the physical modulation is the same, QPSK to 64-QAM.

Evolved HSPA and LTE can easily be integrated to the legacy 3GPP technologies, and UMB can be integrated to 3GPP2 technologies, but WiMAX is harder to integrate. As these new technologies become introduced to live networks, there will be huge requirements also for the transport networks. The theoretical downlink and uplink peak rates and the roundtrip latencies from the Evolved HSPA, WiMAX and LTE (Release 8) are in Table 2. There are also tabled same properties from the HSPA (Release 6) serving as a reference. It can be clearly seen that the forthcoming requirements for the access and core transport networks will be very demanding.

Table 2. HSPA release 6, Evolved HSPA, WiMAX and LTE release 8 downlink and uplink peak rates and roundtrip latencies [BRO07a].

<b>Factor</b>	<b>HSPA R6</b>	<b>Evolved HSPA</b>	<b>WiMAX</b>	<b>LTE R8</b>
Downlink peak rate (Mbit/s)	14	42	80	160
Uplink peak rate (Mbit/s)	5	11	16	50
Roundtrip latency (ms)	50	30	30	10

## **2.2 Mobile services**

Traditionally, until about to mid-90s there was only one service which was used in the mobile networks: voice calls. From the end of the 1990s, however, the usage of mobile network for data traffic purposes began growing all the time. That is the main reason for developing new and advanced mobile network technologies in both the radio as well as transport layer networks.

As there is a multiplicity of different voice, data and video services in the mobile networks and certain service classes need to be developed to classify the different services by suitable characteristics.

### **2.2.1 Service diversity**

In the first generation mobile networks, there were only two services available: speech and signalling. The speech service was the only real user service as the signalling was only used to manage the voice calls, handovers, frequency allocation, etc. Starting from the second generation mobile networks, for example, GSM networks, the new service introduced was the data service, which included data connections to the other networks, for example, to the Internet, short messaging services, paging services, and so on. These all data services were handled in the access network with the same priority as the voice service; they always reserved the same bandwidth and received the same quality of service. Also, there was no real difference between the different data services, there were just “calls” that were either for voice, data or signalling purposes.

When the 2.5 generation networks, for example, GPRS networks, were introduced, the use of mobile networks for data transportation increased dramatically. In the radio access network, a division was made between the circuit switched and packet switched networks. The amount of various data services increased with the introduction of, for example, the Multimedia Messaging Service (MMS), the Wireless Application Protocol (WAP) and the direct Internet connection.

From the GPRS days to these days and beyond, the mobile networks have moved more and more towards packet switched networks. In the future, all services can be packet switched, including the speech service. With limited transport capacity, the service classification has become an important feature of modern networks. Normally, the signalling and speech traffic wishes to be identified and prioritized as the most important traffic in the network, but as there can be important data services, the qualification and prioritization processes has become quite complex.

At present, the speech service usually goes through the circuit switched parts of the GSM and UMTS networks, the places where the real-time latencies are guaranteed. The data services, however, are transported in the packet switched network and as the operators have changed their pricing models towards flat-rate, the need to optimize the costs of transport networks effectively has become more and more important.

## **2.2.2 Service classes in the mobile networks**

The 3GPP's specification 23.107 [23.107] specifies the QoS concepts and architectures for the mobile networks of the 3GPP releases, which are applicable to the mobile networks in the GSM evolution. Such networks are, for example, GSM, E-GPRS and UMTS. The specification defines four different quality of service classes:

### **Conversational class**

The conversational class is the most commonly used by telephony speech. It can also be used by other speech services, such as VoIP and video conferencing data. The requirements for this real-time service class are strictly dictated by human perception, which requires low delay and delay variation.

### **Streaming class**

The streaming class is mostly used for one way data transport only. The usage cases can be, for example, a user listening or looking for real time audio or video. The delay variation of the class is roughly fixed, but there are no requirements for the low delay itself. In any case, acceptable delay variation is higher than the delay variation by human perception, such as in the conversational class.

### **Interactive class**

The interactive scheme is applied, when the online data is requested from some remote piece of equipment, for example, applications which are web browsing and accessing databases. The characteristics of this class are a low round-trip delay and a satisfactory bandwidth with a low bit error ratio.

### **Background class**

The background class is typically used in data file transportation. It can be, for example, Short Message Service (SMS), E-mail and database downloading. The basic idea of this class is that the destination does not expect the data to arrive in a certain time.

The above QoS classes in the 3GPP networks are presented in Table 3.

Table 3. UMTS QoS classes.

Traffic class	Conversational class	Streaming class	Interactive class	Background
Delay	- Conversational pattern (stringent and low delay )	< not specified >	- Request response pattern	- Destination is not expecting the data within a certain time
Delay variation	- Preserve time relation (variation) between information entities of the stream	- Preserve time relation (variation) between information entities of the stream	< not specified >	< not specified >
Loss	< not specified >	< not specified >	- Preserve payload content	- Preserve payload content
Example of the application	- Voice	- Streaming video	- Web browsing	- Background download of emails

Although, the table contains four QoS classes, in practise, the operators have only used one or two classes. Either moving all speech data to the conversational class or dividing it so that the speech travels along the conversational class and everything else stays in the background class. The traditional GSM networks have only had one service class, because of the nature of TDM transport, making both speech and data traffic to share all resources equally. But as the amount of data was traditionally small until the E-GPRS rollout, it is only now when problems have started to become more significant when the packet data traffic has starting to overtake speech. That is why 3GPP's and other 3<sup>rd</sup> generation mobile networks had to implement service classes.

As the transport technologies have also specified the QoS mechanisms, the 3GPP's four service classes are rather easy to map between the different transport technologies. If the technology makes it possible to use more than four classes, the remaining classes can be used for signalling purposes. More will be said about the different QoS mechanisms in the different transport technologies and their collaboration will be covered in greater detail in the next chapter.

Before the 3GPP's specification of the four service classes, the used QoS mechanisms in GPRS networks were considerable different. It was defined, that for each data flow having a QoS associated with it, the following properties were defined:

- precedence (3 different classes)
- delay (4 different classes)
- reliability (5 different classes)

- peak throughput (9 different classes)
- mean throughput (19 different classes)

As each property had a different amount of classes, which created a possibility choosing up to 10260 different QoS schemes, the delivery of the QoS parameters was problematic. Users and operators desired the mechanisms to be as simple as possible, and for that reason the QoS mechanisms were simplified in the 3GPP networks.

### **2.2.3 Quality of the end-user Experience**

Services and the service classes need to be bound together. This can be done by using Quality of the end-user Experience (QoE), which is the term used to describe the perception of end-users on how usable the services are [SOL06]. However, it seems like QoE has as many definitions as it has books related to it. And together with the help of Quality of Service (QoS) concept, the networks and services should achieve the maximum user rating. In order to provide the best QoE, there is also a need for management of QoS issues.

It leads to the situation, that when new mobile services are introduced, the QoE requirements for the service have to be considered. After classifying the requirements for the service, we can define the QoS class needed with the suitable parameters for it. The QoS parameters defined should then be fixed across the whole network, from service provider to user, or from user to user. All this makes it mandatory to have the classes unchanged also in the interfaces of the different network technologies. By using the four 3GPP network QoS classes, the services are relatively easy to categorize to these classes. 3GPP's specification 22.105 [22.105] defines the different services and their requirements per class. Tables 4, 5 and 6 list the most frequently used services and their requirements categorized by real-time, interactive and streamed services.

Table 4. End-user Performance Expectations - Conversational / Real-time Services.

Medium	Application	Degree of symmetry	Data rate	Key performance parameters and target values		
				End-to-end one-way delay	Delay variation within a call	Information loss
Audio	Conversational voice	Two-way	4-25 kbit/s	<150 msec preferred <400 msec limit Note 1	< 1 msec	< 3% FER
Video	Videophone	Two-way	32-384 kbit/s	< 150 msec preferred <400 msec limit Lip-synch: < 100 msec		< 1% FER
Data	Realtime games	Two-way	< 60 kbit/s	< 75 msec preferred	N.A	< 3% FER preferred, < 5% FER limit

Table 5. End-user Performance Expectations - Interactive Services.

Medium	Application	Degree of symmetry	Data rate	Key performance parameters and target values		
				One-way delay	Delay variation	Information loss
Audio	Voice messaging	Primarily one-way	4-13 kb/s	< 1 sec for playback < 2 sec for record	< 1 msec	< 3% FER
Data	Web-browsing - HTML	Primarily one-way		< 4 sec /page	N.A	Zero
Data	E-mail (server access)	Primarily One-way		< 4 sec	N.A	Zero

Table 6. End-user Performance Expectations - Streaming Services.

Medium	Application	Degree of symmetry	Data rate	Key performance parameters and target values		
				Start-up Delay	Transport delay Variation	Packet loss at session layer
Audio	Speech, mixed speech and music, medium and high quality music	Primarily one-way	5-128 kb/s	< 10 sec	< 2sec	< 1% Packet loss ratio
Video	Movie clips, surveillance, real-time video	Primarily one-way	20-384 kb/s	< 10 sec	<2 sec	< 2% Packet loss ratio
Data	Still image	Primarily one-way		< 10 sec	N.A	Zero



## **3 Mobile access networks**

The mobile or radio access networks (RAN) are discussed in this chapter, which presents a short overview of the access networks and concentrates on the transport part of the access networks that can also be called backhaul networks. Emphasize is based on the delivery of the service quality and the operation and maintenance capabilities among the different network architectures. These need to be defined for the performance management systems. Additionally, the protocol stacks of the different 3GPP release radio access networks are examined and seen how the different protocols interwork.

### **3.1 Overview**

According to 3GPP, the radio access networks can be divided into two network layers: the radio network layer (RNL) and the transport network layer (TNL) [25.401]. The radio network layer includes all the logical radio access nodes and the interfaces between them, while the transport layer takes care of the transmission between the radio access nodes. Transport networks can also provide transmission to the other networks, for example, to the PSTN or to the Internet.

RNL equipment and interfaces are closely specified and standardized by 3GPP and other standardization organizations, but the TNL has traditionally been a network operator issue; only interfaces for TNL are specified.

A good overview of the mobile transport network is presented in Figure 3.

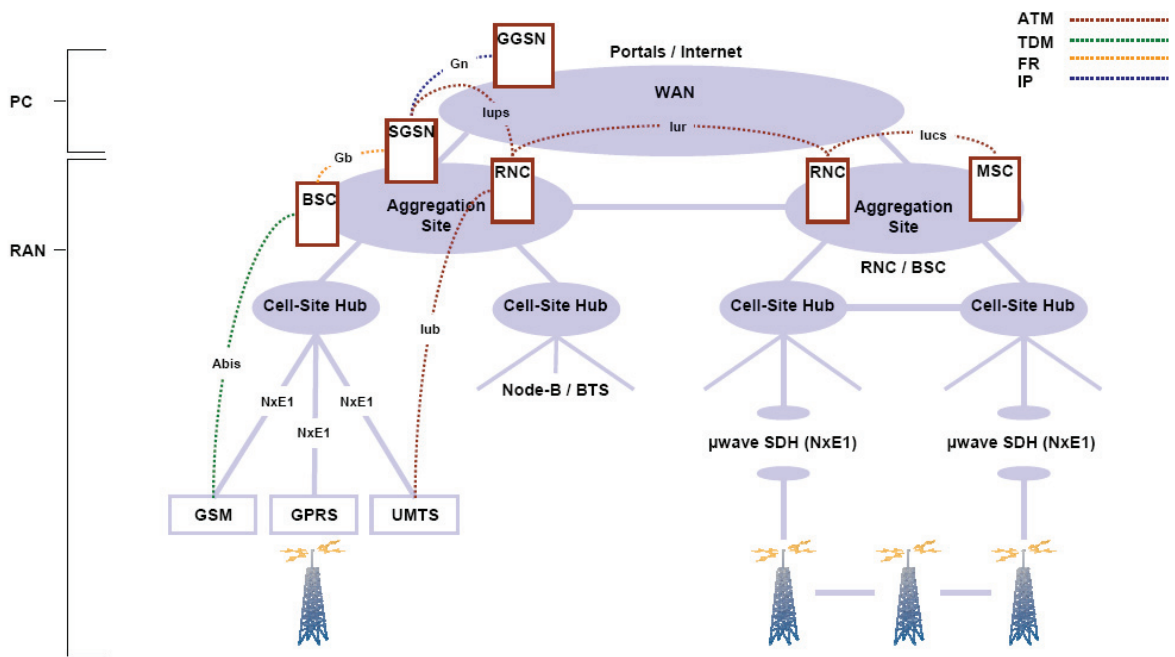

Figure 3. Transport Network Overview [JAC05].

In Figure 3 we have an example of the typical division between different mobile sites. The nearest site for subscribers is a cell site (or Cell-Site) containing the base station with transceivers that enable different mobile technologies. In this example there are three technologies: GSM, GPRS and UMTS. One site can have base stations for different operators if and when the additional transport capacity is leased to competitors. The next site is called an aggregation site. Its size and equipment can vary: in more populated areas the aggregation site can contain several BSCs and RNCs, and is then connected to a higher level aggregation site containing also SGSNs and MSCs. In less populated areas the aggregation site includes BSCs and RNCs together with the SGSN and MSC. Usually these aggregation sites additionally include GGSNs for Internet connections.

The whole thesis focuses on the radio access network part that includes the Iub and other interfaces between the radio networks and the transport network.

### 3.2 Mobile transmission network technologies

As discussed before, mobile transport networks are used between the logical radio network nodes and the interfaces. The transport networks are usually divided into two parts: access networks and core networks. The access networks provide the transport access to the radio networks, for example, in the UTRAN, the Iu, Iub and Iur interfaces are located in the transport network. A simple architectural picture of the UTRAN is shown in Figure 4. The Iu interface can be divided to the Iu-CS and Iu-PS interfaces (or Iups and Iucs), depending which one of them is connected to the CS or to the PS network. The core network and its technologies and architectures are not covered in this thesis.

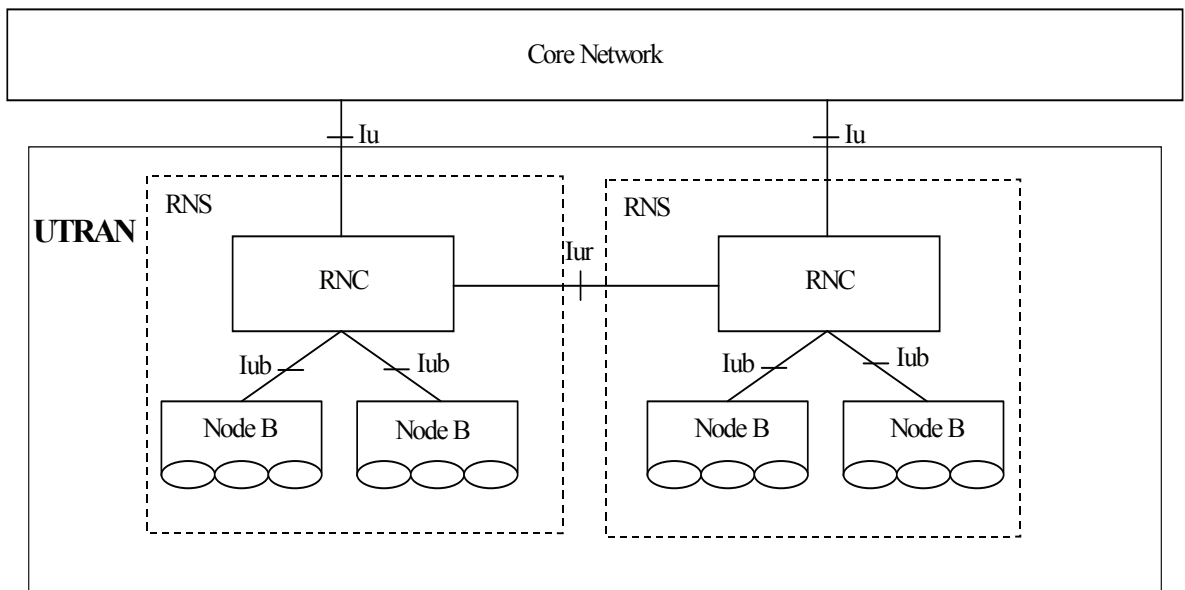

Figure 4. UTRAN architecture with Iu, Iub and Iur interfaces [25.401].

In the access network, the most interesting interface is the Iub interface. The different 3GPP releases use quite different protocol stacks in that interface. Until the 3GPP Release 4, ATM was the only option for the transmission technology. Since Release 5, however, the technology has not been strictly specified and the most commonly used technologies have been the ATM as well as IP. ATM still remains popular, because the

operators upgrading their current 2G network to 3G want to use the existing SDH or PDH network infrastructure which ATM is very easy to implement over [GIN99]. The protocol stack for RNL and TNL in Iub is shown in Figure 5, as it is specified in Release 7 [25.430]. The figure clearly shows these two options, ATM or IP, used for all planes.

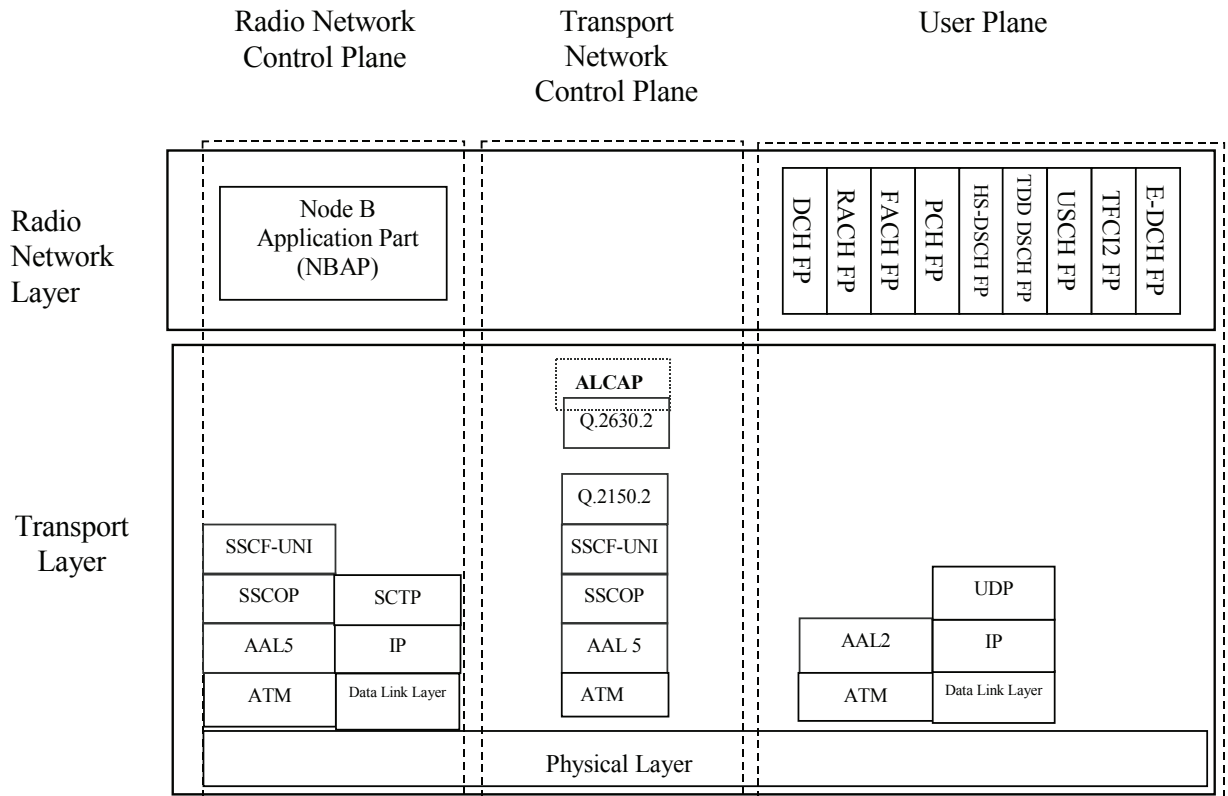

Figure 5. 3GPP Release 7 Iub interface protocol structure.

Following sections list some of the most important network technologies that are used in the radio access transport networks. Some of their important features are studied, but also the QoS capabilities and the possible OAM mechanisms and functions. The reason for studying QoS mechanisms is their importance in dimensioning and optimizing processes of mobile networks. These issues will be discussed in Chapter 7. OAM mechanisms and functions are studied to be able to learn, what capabilities the technologies have for the performance management systems, including the fault management and connectivity tests.

The chapter also introduces MPLS technology that can be used for mobile network protocol interworking.

### **3.2.1 TDM**

In the 2G networks, which include GSM, IS-95 and D-AMPS among other similar technologies, all the calls are traditionally transferred over a TDM network. This is because the GSM technology is intended for voice and all traffic is symmetric and utilizes only the 64 kbit/s timeslots. Also, some newer packet switched technologies, for example, GPRS, have been used in the same transport infrastructure. In the mobile access networks, the most widely used TDM based networks are the PDH and the SDH/SONET networks.

The most commonly used PDH technologies include E1 and T1. T1 is an ANSI standard which has been used in the United States and other countries using ANSI standards, while E1 is being used in the ETSI standard countries. E1 has a bandwidth of 2048 kbit/s, whereas T1 has the bandwidth of 1544 kbit/s. They are both, however, multiples of the 64 kbit/s standard for a single voice call.

SDH networks are used in ETSI standard countries and its basic unit to transmit is called STM-1, which operates at 155.52 Mbit/s but it also has multiples, for example, STM-4 (with 622.08 Mbit/s) or STM-16 (with 2.488 Gbit/s). SONET standards, used in the ANSI countries, use the same bandwidths as ETSI's STM-n, but they are called STS-n. STS-3 corresponds to STM-1, STS-12 to STM-4 and STS-48 to STM-16.

The TDM technologies are excellent for transporting voice calls as in the mobile radio networks, for example, in GSM, up to 4 voice calls can fit into one 64 kbit/s timeslot. And additionally, one E1 line includes 32 timeslots, the E1 can have up to  $20 * 4 = 80$  voice calls, if the remaining timeslots are reserved for signalling purposes.

The TDM technologies do not really have any quality of service functions because of the characteristics of the technologies which are not packet switched and therefore the packets cannot be prioritized. If there is a connection in the circuit switched network,

then all the timeslots will be transmitted over the network. Therefore, the connection status, which can be described as the circuit in PDH or SDH networks, can only be either on or off.

Despite of that, TDM technologies have some OAM capabilities. The one OAM function that can be measured in the TDM networks is the bit error ratio. The PDH/SDH technologies have certain means, depending on the physical layer architecture that is used, of calculating the bit error ratio which can be monitored in the far end of the circuit or connection. Additionally, the trail trace function can be used for the connection verification.

PDH and SDH systems have three functions for defect detection and clearance [G.775]: loss of signal (LOS) if there is no transition, alarm indication signal (AIS) for reporting a near-end defect, and remote defect indicator (RDI) for reporting a remote defect.

The nodes also calculate cyclic redundancy check to verify accuracy of PDH / SDH frames. One good indicator for connection breaks is if the synchronization signal within a network will be lost.

### **3.2.2 Ethernet**

Ethernet is not specified in any way to be used in mobile networks, but it is a very powerful transport technology to use in the transport network layer. This is mainly because the Ethernet equipment, which contains routers, switches and bridges, is relatively low cost. When comparing the prices of Ethernet hardware to, for example, SDH/SONET hardware prices, the difference might be quite significant.

Furthermore, as the Ethernet link bandwidths can be easily up to 10 Gbit/s, and the majority of the current operators usually already have an Ethernet backbone deployed, it makes Ethernet a very good choice for also mobile access transport technology.

#### ***Quality of Service in Ethernet***

In the original Ethernet frame there is no capability to transfer any quality of service based information within the Ethernet network because there is no such QoS field in the original Ethernet header. Ethernet relies on the higher layer protocols to handle the

service quality differentiation issues. In any case, it will be highly problematic if the network switching is done only in the Ethernet layer.

Hopefully, the use of the VLAN extension has been able to correct this problem. The VLAN tag in the Ethernet header has a certain Priority field [802.1p]. The Priority field has the size of 3 bits making the system capable to deliver 8 different QoS classes.

### ***Ethernet OAM functions***

It is necessary to specify Ethernet OAM functions, if similar OAM methods, for example, loopback and trace that are used in TDM and ATM networks, are to be used also in Ethernet networks.

For these functions, there are a few terms of Ethernet OAM mechanics that need specifying [Y.1731]. The Maintenance Entity (ME) is a managed entity which is in a relationship between the two Maintenance Entity Group End Points. The Maintenance Entity Groups (MEGs) are groups that include different MEs. MEG End Points (MEPs) are the endpoints in the MEG that are capable of initiating and terminating OAM frames that are related to fault management and performance monitoring. The real Ethernet flows are not terminated in MEPs, but the OAM frames can be sent along the flows to have the same behaviour. A picture of the Ethernet OAM ME / MEGs and MEPs with the Continuity Check OAM function can be found in Figure 6.

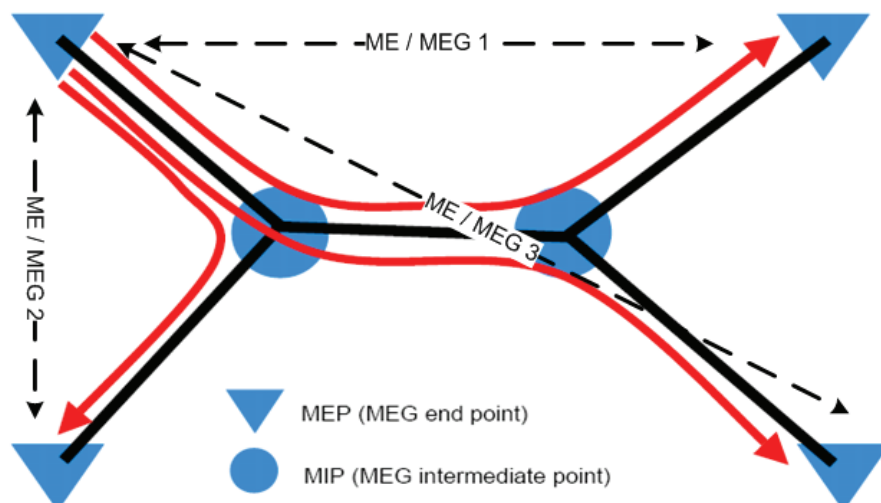

Figure 6. Ethernet OAM ME / MEGs and MEPs with Continuity Check OAM function [OHT06].

According to ITU-T's recommendation Y.1731 [Y.1731], there are several functions developed for the OAM purposes of the Ethernet layer. The functions are divided into two groups depending whether they are related to fault management or performance monitoring.

Some of the most important Ethernet OAM fault management functions consist of:

- Continuity check
- Loopback
- Link trace
- Alarm indication signal
- Remote defect indication
- Locked signal
- Test signal
- Maintenance communication channel

The Ethernet *Continuity check* function is used for proactive OAM. It detects the loss of continuity and also unintended connectivity between MEPs, as in Figure 6. It is applicable for fault management, performance monitoring and protection switching.

Ethernet *Loopback* function is used for connectivity verification of the MEP. It can be unicast or multicast. Unicast is used for bidirectional connectivity end-to-end and for some diagnostics (in-service or out-service) between the MEPs. The multicast is only used for bidirectional connectivity between the MEP and the peer of the MEPs.

The *Link trace* function is used for retrieving adjacency relationships between the neighbour MEPs. It can also be used in fault localization.

The *Alarm indication signal* is used to suppress alarms after a defect notification. After the MEP detects the defect, it starts to send AIS frames. When the defect is removed, the MEP stops sending the frames containing AIS information.

With the *Remote defect indication*, the MEP communicates to its peer MEPs that a defect has been encountered. It is sent and noticed in a way similar to the AIS frames.



The Ethernet *Locked signal* function is used to communicate to the other MEP about the administrative locking and consequential traffic interruption. The locked signal can be used, for example, with the Test Signal function.

The *Test signal* is used for in-service and out-service diagnostics tests which include, for example, bandwidth throughput, frame loss, bit errors, etc.

With the *Maintenance Communication Channel*, a pair of MEPs can have their own communication channel for maintenance purposes.

Overall, the above functions allow detection, verification, localization and notification of different defect conditions and they can be applied to both point-to-point and multicast connection types.

The performance monitoring functions permit measuring the different performance parameters and they are applied only for the point-to-point connections. The Ethernet OAM performance monitoring functions include:

- Frame loss measurement
- Frame delay measurement
- Throughput measurement

The *frame loss measurement* is defined as the percentage of frames lost during a constant time interval.

The definition for *frame delay measurement* is the time from when the source node starts to send the first bit, to when the same source node will receive the last bit from the looped back destination node. Due to this, the frame delay measurement needs the loopback functionality in the destination node to be performed.

The *throughput measurement* is the maximum rate where no frames are dropped which was originally identified in IETF's recommendation RFC 2544 [RFC2544].

### **3.2.3 ATM**

In the first 3GPP releases, Release 4 (or Release 99) and earlier, ATM was the only transport protocol specified for the UMTS and GSM/EDGE radio access networks. One reason for this was that ATM could use the existing TDM infrastructure when

upgrading from 2G to 3G. ATM transfer rates are dependent on the physical connection, so usually the physical layer to use with ATM is either SDH or SONET. Therefore, for example, by using STM-1 connection, the ATM connections can achieve a transfer rate of up to 155.52 Mbit/s. ATM cells are identified with the Virtual Path Identifier (VPI) and the Virtual Circuit Identifier (VCI) as the cells always belong to some virtual path and virtual circuit. The virtual paths and circuits are logical connections, and the ATM switches can usually configure some cell rate and maximum delay characteristics for them according to which service class the path or circuit is meant to use.

ATM control functions are designed for the ATM Adaptation Layers (AAL) that are numbered from 1 to 5. The different AALs have different characteristics depending on what kind of traffic they are meant to transfer. Traditionally in the ATM transport, the AAL1 and AAL2 have been used to transport CS services and AAL5 to transport the PS services [MIC05]. AAL5 is also used to transfer all the control plane traffic.

### ***Quality of Service in ATM layer***

According to the ATM Forum [AF-0121], ATM architecture has six different service classes:

- CBR – constant bit rate
- rt-VBR – real-time variable bit rate
- nrt-VBR – non-real-time variable bit rate
- UBR – unspecified bit rate
- ABR – available bit rate
- GFR – guaranteed frame rate

These six classes can be divided into two by their ability to transfer real-time services. Two classes, which include CBR and rt-VBR, are the only service classes that are suited to real-time data transfer. CBR can have only the peak cell rate whereas rt-VBR can additionally define the sustainable cell rate.

All the ATM service classes, excluding the GFR class, are applicable to both ATM virtual connections, to the VP and VC connections. Frame-aware GFR is only

compatible with VC connection, because its frame delineation is not visible to the virtual path level.

The two last service classes, ABR and GFR, are nowadays rarely used. The addition of the UBR service class allows users to setup Minimum Desired Cell Rate parameter, which indicates the minimum bandwidth allocation for the connection [AF-0150]. Also, Cisco Systems have developed a new UBR+ class, which allows defining the minimum and maximum cell rate [CIS8603].

### ***ATM OAM mechanics***

In the ATM systems, depending on the VP or VC levels, there are two different kinds of flows for maintenance purposes: F4 and F5 [I.610]. The OAM flow for the virtual path level is called F4 and for the virtual channel level it is called F5. Both flows are bidirectional and they follow the same physical route as the user data cells over the network. For this reason they can be considered as in-band maintenance flows.

The ATM OAM cells are certain kinds of ATM cells that are identified in the cell header. In the F4 level (or VP level), the different kinds of OAM messages or functions are differentiated by the VC identification number as shown in Table 7.

Table 7. Different OAM cells at F4 level.

<b>VCI</b>	<b>Interpretation</b>	<b>Category</b>
0	Unassigned cell (VPI = 0)	Non-user cell
0	Unused (VPI > 0)	
1	Meta-signalling cell (UNI)	User cell
2	General broadcast signalling cell (UNI)	
3	Segment OAM F4 flow cell	Non-user cell
4	End-to-end OAM F4 flow cell	
5	Point-to-point signalling cell	User cell
6	Resource management cell	Non-user cell
7-15	Reserved for future standardized functions	
16-31	Reserved for future standardized functions	User cell
VCI > 31	Available for user data transmission	

The VP Identifier (VPI) field of the cells containing the F4 level messages are the same as the cells that contain user data.

In the F5 level (or VC level), the OAM messages are separated with Payload Type Identifier (PTI) codes. The separation is shown below in Table 8.

Table 8. Different OAM cells at F5 level.

<b>PTI code</b>	<b>Interpretation</b>	<b>Category</b>
000	User data cell, congestion not experienced	User cells
001		
010	User data cell, congestion experienced	
011		
100	Segment OAM F5 flow cell	Non-user cells
101	End-to-end OAM F5 flow cell	
110	Resource management cell	
111	Reserved for future standardized functions	

Perhaps the most used mechanism for distributing OAM cells on both the F4 and F5 level connections are end-to-end and segment cells. End-to-end flows are used for VP or VC connection end-to-end communications and they must be terminated at both ends. The end-to-end flow uses the whole VP or VC connections to check the connection; it is not interested in the segments on the connections.

On the other hand, segment flows in the F4 and F5 levels are used for the communication between the boundaries in one VP or VC connection segment. Along the VP or VC connection, one or more segments can be defined, but they cannot be overlapped or embedded. This means, that along the VP or VC connections, each endpoint that is set to be a segment endpoint will end a segment, but also start a new segment. Figure 7 shows an example of a VP connection having an end-to-end and two segment connection flows.

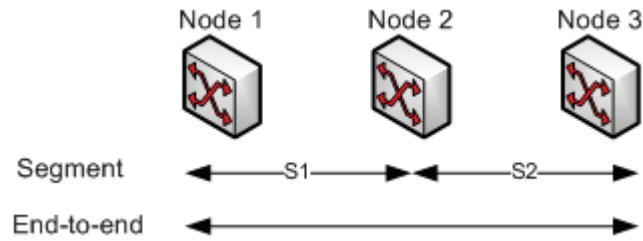

Figure 7. ATM segment and end-to-end connection flows.

### ***ATM OAM functions***

Table 9 lists the current OAM functions used for the ATM layer. The *Alarm Indication Signal* and *Remote Defect Indication* are used for the forward and backward defect reporting. The *Continuity Check* can be used, for example, to send certain kinds of cells in a fixed time interval.

The *LoopBack* is a powerful function for different kind of maintenance purposes. According to ITU-T's recommendation I.610 [I.610], the loopback function consists of the following applications depending where and how they are used: end-to-end loopback, access line loopback, inter-domain loopback, network-to-endpoint loopback and intra-domain loopback.

The performance monitoring in the VP and VC connections is done by inserting monitoring cells in the end of the connection or segment. This procedure is communicated between the endpoints with the *Forward Performance Management* cells. Then the results are received with the reverse flow with the backward reporting cells. The performance management is done by monitoring the variable blocks of the user cells.

The *System management* cells are to control and maintain various functions in the VP or VC layer, depending on the F4 or F5 flow used by different systems. *ATM Protection Switching* cells are defined for switching the protection of the ATM connection.

Table 9. OAM functions in the ATM layer.

OAM function	Main application
AIS	For reporting defect indications in the forward direction
RDI	For reporting remote defect indications in the backward direction
CC	For continuously monitoring continuity
LB	For on-demand connectivity monitoring For fault localization For pre-service connectivity verification
FPM	For estimating performance in the forward direction
Backward reporting	For reporting performance estimations in the backward direction
Activation/deactivation	For activating/deactivating PM and CC
System management	For use by end-systems only
APS	For carrying protection switching protocol information

### 3.2.4 IP

Using IP technology in the radio access networks is not that common. IP is placed on the OSI layer 3, while the other transport technologies are on the layer 2. That makes it compulsory to IP to use some of the layer 2 technologies. As the networks will transform more and more using packet based technology, this raises a question whether the access transport networks should be switched or routed. In the future, operators will have to make careful calculations to see, if the radio access transport networks should be transformed to routed networks and will this provide any business benefit for that. In any case, the use of IP has an advantage only if the network is routed, not switched.

In the future, however, the next generation wireless technologies, such as LTE, will probably lean on the flat all-IP radio access networks [BRO07b], depending on the willingness of the leading mobile operators and vendors to make such investments. 3GPP will probably propose such RAN standards in the near future.

#### *QoS in the IP based networks*

Originally the network routers managed all IP traffic as best effort traffic. However, in the headers of the IP frame Type of Service (ToS) field was specified, enabling to define the used service quality, but not the resource reservation. Nowadays, the service

quality with IP traffic is made using differentiated services (DiffServ) or integrated services (IntServ). Since the DiffServ is easier to deploy into the IP infrastructure than the complex IntServ, a specification has been made to deploy the original ToS field in IP version 4 header to a 6-bit Differentiated Services Code Point (DSCP) [RFC2474]. This procedure allows the use of a total  $2^6 = 64$  different quality of service classes.

### ***OAM in the IP based networks***

IP does not really have any OAM capabilities, as where IP is used, the OAM mechanics and functions have been left for the lower layer protocols to take care. As the IP resides in the OSI layer 3, the suitable layer 2 protocol can be, for example, Ethernet, MPLS or ATM, which all have specified OAM functions and mechanics.

Furthermore, there are some IP functions that can be thought of as OAM functions: IP *ping* and *traceroute*. Ping can be used for checking the connectivity for the end-to-end IP route and the traceroute function for confirming the route of the end-to-end connection.

### **3.2.5 MPLS**

MPLS has been developed as a versatile, low-overhead and cost effective network architecture for modern packet switched networks that require large bandwidth management. The advantage of the MPLS networks is a capability to encapsulate other different transport protocols and the traffic engineering capabilities with a traffic engineering extension. It also includes the necessary signalling protocols to discover, configure and manage connectivity in the network.

The usage of MPLS in the radio access networks makes it possible to encapsulate some other layer 2 technologies on inexpensive Ethernet or IP networks. For example, if an operator establishes a new base station site connection, the most efficient connection to be built on it would most likely be Ethernet. But as the base station equipment uses TDM or ATM connections, these connections could be encapsulated on the MPLS and the MPLS connections could be built over the cheaper Ethernet connection between the base transceiver station and base station controller, or respectively between the Node B and radio network controller. The MPLS encapsulated connections are called the

pseudo wire edge-to-edge emulation (PWE3) that are usually provisioned from some network management system. The specification for PWE3 architecture can be found in IETF's RFC 3985 [RFC3985].

### ***QoS in MPLS based networks***

As there can be two different kinds of label switched paths (LSP), E-LSP and L-LSP, in the MPLS network their service quality is provided in two different ways. E-LSP can provide up to eight different service classes in the 3-bit Experimental field in the MPLS frame. In the L-LSP, however, each service class used needs its own LSP to be established. Then the Label field in the MPLS frame will describe the service class. [RFC3270].

### ***MPLS OAM mechanics, techniques and functions***

There are different kinds of OAM packets for OAM purposes in the MPLS networks. According to ITU-T's recommendation Y.1711 [Y.1711], the packets for the different techniques are described below:

- Connectivity Verification (CV)
- Fast Failure Detection (FFD)
- Forward Detect Indicator (FDI)
- Backward Detect Indicator (BDI)
- Performance, trace and loopback

With the CV, the availability of the LSP can be monitored, as it is generated with the frequency 1/s in the source LSR and terminated in the sink LSR of the LSP.

FFD can also be used for the connectivity verification, in addition to the failure detection option. The FFD packets contain the same information as the CV packets, but their insertion rates can be different, usually faster than 1/s. Consequently, as the CV LSP can detect a defect within 3 seconds, the FFD LSP is able to detect it faster in 150 milliseconds.

The FDI flow is used to respond to the detected defects, its purpose being to suppress the alarm in the network layer above the layer where the defect occurred. It can be



generated in the LSR which first detects the defect, or in the LSP which terminates all the MPLS layer defects.

With the BDI flow, the upstream LSP can be informed that there is a defect in the downstream LSP sink point.

Performance, trace and loopback techniques are, according to ITU-T recommendation Y.1711, currently under study. In other words, at this time there are no specified techniques for either performance monitoring or management in the MPLS networks.

All the above mentioned techniques are applied to a single LSP, not on many LSPs. If it is desirable to monitor a segment within the LSP, another LSP service layer has to be created on it. All the different OAM packets are identified by different codepoints that are the first octets in the OAM packets' payload. The different codepoints mapped to the OAM functions are listed below in Table 10.

Table 10. OAM function type codepoints.

<b>OAM function type codepoint (Hex)</b>	<b>First octet of OAM packet payload function type and purpose</b>
00	Reserved
01	CV (Connectivity Verification)
02	FDI (Forward Defect Indicator)
03	BDI (Backward Defect Indicator)
04	Reserved for Performance packets
05	Reserved for LB-Req (Loopback Request)
06	Reserved for LB-Rsp (Loopback Response)
07	FFD (Fast Failure Detection)

The MPLS OAM packets themselves are identified from user packets by label field in MPLS header, referred as "OAM Alert Label". The recommended numerical value for the OAM Alert Label is 14.

### **3.3 Access network technology interworking**

As discussed in previous sections, there might be multiple different transport technologies in the radio access networks. One of the main reasons for this is the location of the base stations. Typically the location of the base station has been built in the 1<sup>st</sup> or 2<sup>nd</sup> generation mobile network era, which means that the first transport technology built into the base station site has been either PDH or SDH to cover the TDM transport needs. After the UMTS rollout, there has also been a need to transport ATM in the access network. This has caused a need to build either a new ATM transport network or to transport ATM over the existing PDH or SDH network.

From 3GPP's Release 5 network and beyond, the Ethernet technology has been the desired transport technology in the same access network. The operator can either try to use the existing ATM network or build a new Ethernet based network at the base station site. Whichever way is taken, problems arise: if using the existing ATM network, the Ethernet frames are needed to be encapsulated into the ATM cells; and if a new Ethernet network is built, the older ATM and/or TDM traffic needs to be transported over the Ethernet.

Additionally, base station sites usually have many different radio technologies in operation, and all the transport technologies should work independently. This is why there has to be support for multiple transport network protocols.

Usually network operators seek to transport all traffic, regardless of origin or destination, over the same wire. This is normally the most cost effective way, as there is no need to maintain multiple wires. There are some solutions to meet demands of multiprotocol usage. One of the best solutions is to use the MPLS technology over the Ethernet to encapsulate the other layer 2 technologies, as was mentioned above in the section dealing with MPLS. There are still, however, some problems related to QoS and OAM delivery between the different network technologies in this interworking scheme. Some studies have been made in the field of mapping the QoS classes or parameters between the different technologies, with the basic idea being to map some service class to another with some predefined settings. The biggest problem in this mapping occurs when one technology has fewer classes than another, for example, when mapping a

6-bit DSCP field of an IP frame to 3-bit VLAN priority bits in the Ethernet frame. The same problem occurs when mapping ATM's traffic classes, since the ATM traffic class information is bound to virtual path and virtual channel identifiers. It should be possible to solve all major problems, if the same mappings are used across the whole access network.

Another challenge is how to deliver the OAM messages between those technologies. For example, in the case that the operator wants to check the connectivity of some segment in the network, where different protocols are used, but only sees the end-to-end connection. Unfortunately, there are no common solutions for the scheme, but perhaps there would be no real usage for such scheme, either.

For the connections to be managed, however, the OAM mechanisms have to be found in the different layers, only if the OAM mechanisms in those layers are relatively similar.

One special synchronization issue occurs if the PDH or SDH timeslots are transported over a packet network. The PDH and SDH connections always need the traffic to be synchronized, otherwise there will be wandering and ultimately bit losses. The problem will be greater if the timeslots are in different packets that are routed via different routes and the delay and especially the jitter is large. The synchronization must be carried out to RNC's or BSC's clock and the requirements for the stability of the TDM traffic comes from ITU-T's recommendation G.823 [G.823]. Additionally, if the one-way delay needs measuring, the clocks need to be synchronized or else the measurement calculations cannot be trusted. Fortunately, there are some solutions for the synchronization over the packet networks: the use of the adaptive clock recovery or the precision clock synchronization protocol [1588v2].

The issues raised above are the ones that are produced from the mobile access network interworking. In any case, where interworking between telecommunications networks is to be affected, some technical, administrative and financial problems arise [OLS98]. These problems are also usually related to the control and supervision of the networks. And it is for this reason that the operators usually maintain a dedicated management

network, which is used to manage different network types. Nowadays most of the management functions of the network nodes are controlled using the management networks.

## 4 Network monitoring tools

This chapter includes an overview of the most commonly used network monitoring tools, including performance and fault management (or performance and fault monitoring) which are considered to be a part of the OAM tools. However, as they usually are implemented as separate tools, they are also discussed individually in this chapter. The main focus of the investigation is on the performance management, but the connectivity and fault management issues are also discussed, since they are usually used together in the same management process.

### 4.1 Operation and maintenance

According to ITU-T's recommendation I.610 [I.610], the OAM functions include the following principles with their explanations:

- Performance monitoring (PM)
- Defect and failure detection
- System protection
- Defect information
- Fault localization

*PM* is a function which processes user information to produce maintenance information specific to that user information. This maintenance information is added to the user information at the source of a connection or link and extracted at the sink of the connection or link. Analysis of the maintenance event information at the sink of the connection allows estimation of transport integrity.

Defects and failures affecting the transport of user information are detected by continuous or periodic checking with *defect and failure detection*. As a result, maintenance event information or various alarms will be generated.

In *system protection*, the effect of a defect on the transport of user information is minimized by blocking or changing over to other entities. Consequently, the failed entity is excluded from operation.

*Defect information* is given to other management entities which results in alarm indications being sent to other management planes. Response to a status report request will also be given.

Finally, *fault localization* is determined by internal or external test systems of a failed entity, if the defect information is insufficient.

The first principle, *performance monitoring*, is what is considered as the performance management in this thesis and is discussed in the subsequent chapters.

The second principle, *defect and failure detection*, is the principle that is the most commonly thought of as an OAM function when implemented to some network technology as discussed in the previous chapter.

*System protection*, which refers to means and actions to trigger and maintain the protection, is not within the scope of this thesis. However, the *defect information* and *fault localization* that is related to fault management will be discussed later in the fault management chapter.

In this thesis, there are three different OAM functions or systems that are network monitoring tools related to performance management in the radio access transport network. Therefore the next sections discuss performance management itself, the connectivity test as well as fault management. The OAM capabilities in the transport technologies were discussed in the previous chapter in order to be aware of the possible OAM functions of the specific technology or protocol.

## **4.2 Performance management**

Performance management includes the functions for performance measurements of network services [WAL07]. Depending on the source, the performance management can be defined in different ways. For example, 3GPP's specification for performance management [32.401] focuses more on the ways to manage the performance process, rather than what kind of performance objects need to be monitored. This section focuses mostly on the 3GPP's specification, because it is more oriented on the mobile networks.

In this section we will also learn that there are many ways to implement these measures, as well as to collect the data, depending again on the source.

According to 3GPP, the purpose of performance management is to collect data, which can be used to verify the physical and logical configuration of the network and to locate potential problems as early as possible [32.401]. Any evaluation of the network or system will require recording and collecting of the performance data from the network elements. The recording and collection is usually triggered by the network or element manager. It should be noted, however, that as the ITU-T's OAM recommendations can provide the performance management or monitoring mechanisms and functions for the various network technologies, the 3GPP recommendations define the performance management objects and the actions related to the performance data. To be able to evaluate the mobile networks, the performance data has to be recorded and the data collection triggered by some polling policy.

By modelling the performance management system as processes, it can be divided into two process parts: network quality analysis and network planning and dimensioning [HOR03]. The network quality analysis consists of, for example, end-to-end delay and packet loss while the network planning and dimensioning consists of, for example, the link capacity and load calculations, and traffic engineering. Different performance management systems can cover either one or both of the processes. The network planning, dimensioning and optimizing is usually based on careful network quality analysis and other network calculations that are monitored in the networks.

#### **4.2.1 Monitoring the performance in the networks**

In mobile networks, there are many things to be measured. According to 3GPP's specification for performance management, the different kind of measurements in the mobile networks consist of the following five areas [32.401]:

- Traffic load that includes user and signalling traffic
- Network configuration evaluation
- Resource access

- Quality of Service (QoS)
- Resource availability

*Traffic load* is the usage in the network and the measured values are typically time related, for example, the busy hour.

*Network configuration evaluation* is used for evaluating, for example, the effectiveness of the network plan change.

*Resource access* is used to evaluate how accessible the resources are during the data recording or collecting.

*Quality of Service* indicates the performance experienced by the end user and is used for viewing the service level outside the network.

*Resource availability* is quite similar to resource access, but evaluates the availability of the resources during the data recording or collecting.

As all measurements recorded or collected need to fulfil the above requirements, the 3GPP specification also describes some areas of administration of these measurements. The areas that build up the performance monitoring process include *measurement job administration*, *measurement result generation*, *storage of the measurement results*, *transfer of the result* and finally, *the result presentation*.

In addition, another important standard on the network performance field, ITU-T's recommendation E.880 [E.880], describes the different ways of measuring the performance:

- Reliability performance
- Maintainability performance
  - o Time related performance
  - o Probabilities
- Maintenance support performance
  - o Time related performance
  - o Probabilities
- Availability performance



The most commonly used ways of monitoring the network performance, therefore, is to monitor traffic load by data collection. This performance data is gathered continuously from the network elements and saved to the performance management system. The performance management system can be a database, a performance server or a performance collection tool.

The results from data collection polling are called performance objects or statistics. For the data collecting process, the ITU-T's recommendation E.880 presents the following criteria:

- Sources of data
- Means of collecting data
- Operation reporting
- Failure reporting
- Maintenance reporting
- Storage, updating and checking procedures

As we learned in Chapter 3, the different network technologies have different ways of collecting and of exchanging the performance information. These depend completely on the OAM mechanisms and functions that are specified for those technologies. Therefore, there are also some common performance indicators and performance objects that can be monitored in the network elements. In the following subsection, some of the most important indicators are discussed.

#### **4.2.2 Performance indicators**

In the performance management process, there are certain indicators that are used to monitor the continuous process. In the radio and transport networks they are often called the key performance indicators (KPIs) or just performance indicators. The different performance indicators are referred to as managed or MIB objects, which are defined in IETF's recommendation RFC 1213 [RFC1213]. Additionally, some of the performance indicators can be derived or calculated from a Management Information Base (MIB) or other performance objects. In this thesis, the term statistics is also used

for the managed performance objects or indicators, since only the performance related objects from the MIB specification are described.

Defined by RFC 1155 [RFC1155], the MIB is a virtual information store accessing the managed objects. The access process is often done by using the SNMP protocol. The MIB is used to specify how the data is stored.

The use of the MIB specifications is not the only way to describe the different performance indicators. But by using the MIB specifications, the different management systems can have a common interface where the SNMP protocol can make the queries across the systems. Also, the OAM methods described in the previous chapter can be used for the queries, depending on the capabilities of the technology used.

The MIB-II objects are divided into the following groups [RFC1213]:

- System
- Interfaces
- IP
- ICMP
- TCP
- UDP
- EGP
- Transmission
- SNMP

In this section, the focus is only on the objects that belong to the *Interfaces* group, since only they are related to the performance matters. The RFC 1213 defines the following object types for the interfaces group that are of relevance to this issue:

- *ifDescr* – A string containing information about the interface.
- *ifType* – What type of interface is in question. For example, Ethernet, E1, DS1 (T1), etc.
- *ifSpeed* – An estimate of the current bandwidth of the interface.
- *ifPhysAddress* – The interface address at the protocol layer, if it has one.
- *ifInOctets* – The total number of octets received on the interface.

- *ifInUcastPkts* – The number of unicast packets that are delivered to the higher layer protocol.
- *ifInNUcastPkts* – The number of non-unicast packets (for example, broadcast or multicast packets) that are delivered to the higher layer protocol.
- *ifInDiscards* – The number of inbound packets that are discarded, even if the packets have no errors, but they are not deliverable to the higher layer protocol.
- *ifInUnknownProtos* – The number of inbound packets that are discarded because they are an unknown or unsupported protocol.
- *ifInErrors* – The number of frames received on the interface that had errors, which prevented them being delivered to the higher layer protocol.
- *ifOutOctets* – The total number of octets transmitted out of the interface.
- *ifOutUcastPkts* – The number of unicast packets that the higher-layer protocol requested to be transmitted.
- *ifOutNUcastPkts* – The number of non-unicast packets (for example, broadcast or multicast packets) that the higher layer protocol requested to be transmitted.
- *ifOutDiscards* – The number of outbound packets that were discarded, even if the packets had no errors. One reason could be to free up output buffer space.
- *ifOutErrors* – The number of frames transmitted out of the interface that had errors, which prevented them to be deliverable to the higher-layer protocol.
- *ifOutQLen* – The length of the output packet queue.

It has to be noted, that the above objects or counters are not applicable to all transport network technologies. For example, IETF has specified a different recommendation for the ATM technology that consist of some different counters [RFC3606]. The counters are applicable to the VP or VC layer, or in both layers. These are, for example, *atmVplStatTotalCellIns* and *atmVclStatTotalCellIns* for the VP layer and *atmVplStatTotalCellOuts* and *atmVclStatTotalCellOuts* for the VC layer.

Also, some other performance objects, not described in the above MIB recommendations, are used in various performance management systems. These are usually vendor specific and queried by the performance or network management system

directly from the network elements by using some network manager specified protocol. This functions differently to the MIB object SNMP queries described in the recommendations. In order for some performance management vendor to support these vendor specific queries, it makes it harder for the user or other vendors to integrate different performance management systems, into one.

As learnt from the third chapter, the different technologies have their own OAM functions that can support performance measurements. The performance monitoring tools can use those functions and methods to measure the performance in the specific network architecture.

Most of the object types, which usually are counters or statistics, cannot be used as performance indicators in themselves. The collected data has to be processed by the performance management system where the data is gathered. This process is usually done by using some mathematical expressions and functions so that the performance statistics usually receive relative %-values. It has been said that the performance indicators are functions of the performance counters. These relative indicators are comparable between the different sizes of networks. Unfortunately, however, the absolute values are not comparable, because the amount and type of the traffic varies [WAL07].

The use of the advanced performance indicators makes the performance management system able to have numerous different functions which can be used depending on the needs of the user or the network.

### **4.2.3 Performance data processing**

After the data has been collected from the network elements or the network objects, such as MIB objects or vendor specific objects, the collected performance data has to be somehow processed. The data can be processed to performance indicators with the mathematical expressions and algorithms, as covered in the previous subsection, but there can be some additional processing methods, too. These can be, for example, the data expression and possible fault triggering.

Performance results can be expressed, for example, in real-time monitoring or in the form of performance reports. Real-time monitoring means continuous monitoring of some key performance indicators or just an employee keeping track of some specific indicators from any graphical user interface. Performance reports are by their very nature historical reports taken from a certain time window. These reports are usually exported to some common file format, for example, to comma-separated values (CSV) that can be opened with some spreadsheet application enabling various calculations and creation of additional reports.

Fault triggering means that the performance values or calculations are compared to some specific thresholds and if these thresholds are crossed, the fault management system is notified. For example, if one link has a utilization threshold set at 80 %, and the performance system gives the utilization value of 85 %, a fault or alarm will be triggered. The fault triggering mechanisms need the fault management system to be integrated into the performance management system or otherwise they should be able to exchange information via a common interface between these separate systems.

#### **4.2.4 Benefits from the performance management**

Benefits of the performance management system have been rather small until the rollout of the faster wireless technologies over the last couple of years. Traditionally, there have been two good reasons for performance management in all kinds of networks. First of all, if the traffic is totally jammed, there might be a fault in the network that has been produced by broken network hardware. Consequently, the network service team has to replace the faulty node or unit. Secondly, the traffic is using too much bandwidth in the network and additional capacity has to be added, requiring the network planners to add more capacity to the congested links or parts in the network.

However, with the newer technologies and their needs from the network as discussed in Chapter 2, greater interest has arisen among the transport network operators to optimize their networks. This is the reason for the need for an efficient performance management process.

The most commonly used performance calculations are perhaps those dealing with in and out utilizations. These indicate the usage of resource, which can be logical or physical interface or a link. They are not closely specified, but most often they are calculated from three RFC 1213 interface objects, *ifInOctets* or *ifOutOctets* and *ifSpeed*, and the calculated values range from 0 to 100 %. If the management system supports setting some in and out utilization threshold values and also supports making a fault when those values are crossed, the operator can see if the link's throughput is becoming dangerously high.

The benefits of the ingress and egress utilization values are quite versatile in any network management system, helping with network planning, by offering the current and historical usage of the links. Additionally, ingress and egress utilization makes it easier to predict the upcoming needs of adding more network capacity. Simply adding the additional capacity, however, is always not the best and economic solution for dimensioning or optimizing the network. These matters are covered later in Chapter 7.

From the business perspective, the purpose for performance management is to verify Service Level Agreements (SLAs). For example, the operator and its customer could have made an agreement that the service level of a certain trunk or link must be over 96 percent. The service level can refer to availability or the bit error ratio. If the service level drops below 96 percent, the agreement has specified some penalties for the operator. That is the reason for the both parties, the operator and the customer, to have a continuous process for SLA verification.

Usually the different mobile operators share one cell site, which means that all these operators have their radio equipment in the same location. In this case it is possible that only one transport network has been built to the cell site. Therefore, some of these operators act as customers for the one operator owning the transport network. In this scenario where the mobile operator has leased its transport network from some different transport network operator, the mobile operator wants to verify the agreed properties of the leased line. And in the case that the mobile operator is also the transport operator, then the SLA verification can be used to optimize the capacity and network usage.

### **4.3 Fault management**

The term fault management can be described in many ways, but overall it is a set of functions that enable the detection and location of failures in the network and schedule the possible repair work [WAL07]. For the 3GPP based mobile networks, 3GPP has specified the requirements for the fault management concept. According, the fault management process consists of fault detection, fault localization, fault reporting, fault correction and fault repairing [32.111-1]. The specification also lists the possible fault types:

- Hardware failure – the malfunction of some physical resource
- Software problem – software bug or database inconsistency
- Functional fault – failure of some functional resource
- Loss of some specified capability in the network element
- Communication failure between network elements or systems

In all of the above cases, appropriate alarms should be generated. Loss of some specified capability in the network element and the functional fault are probably the most common performance related faults. Furthermore, there can be various other causes of fault, which are usually vendor specific and can also be performance related.

For these performance related faults, the fault detection, localization and reporting steps can originate from the performance monitoring or other OAM tool. On the other hand, some functions of performance management require the co-use of some fault management service, for example, when we wish to be notified that some utilization value is exceeded from a certain limit. Some performance management systems, like InfoVista VistaInsight, have the fault management service integrated in their own system, while some other performance management systems just provide basic interfaces for fault management.

Reporting is also an important feature of all fault management systems. In the reports generated there should be seen what the fault type is and where and when the fault or

alarm occurred. Additionally, when it was possibly notified and when repaired (or disappeared in another way). The fault type should be informative, so the fault cause can be easily diagnosed.

#### **4.4 The connectivity test**

Connectivity tests are very important in all networks having different traffic flows and, especially, end-to-end connections. The connectivity test is meant to test the connectivity of the connection, which means verification of the connection's availability as well as to ensure that the packets, frames or bits can run efficiently through the network. The usual method for doing this is to set the receiving end to loop back packets and to test whether the sent packets are then really looped back. This test can also sometimes be referred as packet or circuit loop test, depending on the specific network type.

However, in the routed networks the packet loop test is often not enough to yield the desired results. In these networks it is quite difficult to verify the right connections, as the upper level protocol is usually the one establishing these connections. For example, the Ethernet protocol merely transfers the Ethernet frames to their destination address. If there are many independent TCP connections over the IP frames that are encapsulated to the Ethernet frames, it is very difficult to verify whether the frame loss ratio of one TCP connection is so bad to be concerned unavailable, while the other TCP connection has no frame loss at all. The Ethernet connection is only able to see that some frames are lost, but there is no information as whether they belong to the same TCP connection. This is a nature of TCP connections and there is really nothing to do in transport networks to correct this unfairness.

The connectivity test becomes more informative in circuit switched networks, such as all the SDH and PDH based networks. In those networks, the connection is either on or off and there are no performance related information generated. There are, however, two different mechanisms to monitor the connectivity in TDM networks: either by looping back all the traffic or using trail trace mechanisms. Trail trace means to set



some specific bit pattern to all or some timeslots that are to be sent. Afterwards the receiving end can check, if the received pattern is the pattern sent. For both methods some signaling functions are needed as in the PDH/SDH networks the signaling is usually performed manually by the user. The specification for trail functionality can be found from ITU-T's recommendation G.805 [G.805].

Trail trace is a good method for TDM networks, but it can also be used in packet switched networks. By examining the OAM methods of the different transport technologies in the previous chapter, there are a few functions that are common to those technologies: loopback, connectivity verification and trace.

#### **4.5 Network monitoring process**

By using the performance management and connectivity tests with the fault management and other network management and operation tools, it is possible to manage the whole network management or monitoring process. The performance management and connectivity test tools give input to fault management, which in turn gives input to the network management systems or to the users managing the network. The network management system and the user can then make the necessary corrective actions to change the configuration or to repair possible defects. An example process model is presented in Figure 8.

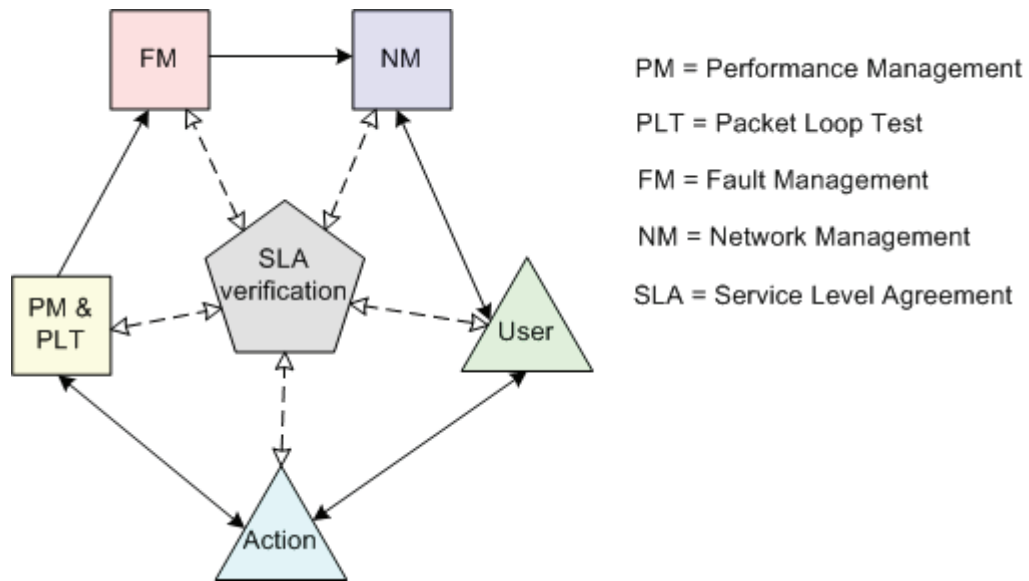

Figure 8. The network management process with the most important functions identified.

The process can be modelled to follow a three-phase root-cause analysis methodology [WAL07]:

- Investigation, which includes performance management and connectivity tests (PM & PLT)
- Analysis, which includes fault management and reporting (FM)
- Decision, which includes the network managing methods (NM, User, Action)

Usually the mobile operators also have the SLA verification process integrated to the whole network management process modelled above in Figure 8. In this way, the SLA can be verified in all the steps of the process by comparing clauses in these agreements with measured performance results.

## 5 Tellabs 8000 Network Manager Performance Management Package

In this chapter the Tellabs 8000 Network Manager Performance Management Package is examined with the focus being on the current features and capabilities of the package. The chapter will also discuss some improvements of the package planned in the near future and its capabilities to integrate with the other performance management systems.

### 5.1 Overview

The Tellabs 8000 Network Manager Performance Management Package (PMS) is a separate modular part of Tellabs 8000 Network Manager which is a network and service management system that integrates Tellabs' own 8600 Managed Edge System and Tellabs and 3<sup>rd</sup> party network element platforms.

The functions of the PMS only manage the performance and it does not handle any connectivity issues or manage possible faults occurring from performance management. The Tellabs 8000 Network Manager has other tools for managing these two issues [8000NM]: *Testing Package* that includes a Circuit Loop Test and a Packet Loop Test for connectivity testing in circuit and packet based networks; *Node Manager* for some other OAM connectivity tests; and *Fault Management* for managing the faults occurring in the network elements managed by the Network Manager.

The Tellabs 8000 Network Manager Performance Management Package can be used in many kinds of networks, but in the mobile world it is mostly used in the radio access networks.

### 5.2 Features

The Performance Management Package helps to view or report different kinds of performance statistics from different kinds of Tellabs' network objects. These objects include [8000PMS]:

- Packet based counters in the Tellabs 8600 system:

- POS PPP
  - Ethernet
  - ATM port
  - IMA group
  - ATM VP and VC
  - Frame Relay
- G.821 and G.826 interfaces or trunks in the Tellabs 8100 and 6300 systems:
    - trunks
    - services that include, for example, PDH and SDH circuits
    - G.704 user access point interfaces

The Tellabs 8000 PMS performance data is collected both from the packet statistics, but also from the G.821/G.826 TDM circuit statistics.

For the best usage by mobile operators, the Tellabs 8000 PMS offers two important features: performance management data for integrating with other performance management systems, and the fault data generated by the Tellabs 8000 Fault Management System which is triggered by the PMS with the configured fault policy.

### **5.3 Collecting and processing data**

The performance statistics are collected at specified time intervals configured by polling policy. These statistics are collected directly from the network elements by the communication server and they are stored in the database. The collection process runs in the background after the time interval has been set.

The user is able to define the length of the time for how long the data will be stored in the database, depending on how much database space the user wants to allocate for the history data storage. The performance data can also be viewed in real-time from the network elements without needing to be first saved to the database.

Some of the statistics are collected by using SNMP queries to the standardized MIB objects, and some of them are collected by Tellabs vendor-specific messages that use

the Application Programming Interface (API) of the Buffered Message Interface (BMI). The reason for using the BMI protocol is due to the fact that not every statistic or counter can be found from the MIB objects. Moreover, some of the statistics can be read directly from the network element by using the command line instructions via, for example, a Telnet connection, because the current development status of the Tellabs 8000 PMS does not include the support for either SNMP or BMI queries for all of the statistics.

In the current status, everything else other than the GR-253 or GR-820 statistics are collected with SNMP queries. In the future, all new features will support the use of the BMI. The BMI protocol is used, because according to Tellabs development, it seems to be about two times more efficient than the SNMP protocol. Furthermore, at this time the technology specific OAM methods are not used for performance data queries. Some other OAM methods are used for connection verification purposes by other Tellabs 8000 Network Manager packages; these include, for example, ATM and MPLS pings, packet loop and circuit loop tests, E1/T1 loopbacks, and so on.

At this time, there are several ways for collecting the performance data to 3<sup>rd</sup> party performance management systems. The most commonly used method is simply to query the raw data from the network element to the Tellabs PMS using either the SNMP or BMI protocols, to generate reports and then to export the reports from the PMS as a CSV file which then opens to some spreadsheet application. This method works well for small data amounts, but when larger data amounts need handling, there are at least three different ways to process the raw performance data:

- Other performance management systems querying historical data from the Tellabs 8000 PMS with some Northbound Interface (NBIF)
- Direct database queries
- Querying data from PMS as data files with NBIF or other mechanisms

The one widely used feature for random monitoring is called a PMS overview. From the PMS overview window the user can see the utilization values per interface or trunk categorized as to how encumbered they are. From the PMS overview window the user

can also see the TDM interfaces that are categorized according to how large bit error ratios they have. This is useful in situations when have been created, for example, several logical connection or pseudowires and the operator wants to check if the system can handle the increased load in the managed network. An example picture of the PMS overview window can be seen in the next subsection in Figure 10.

## 5.4 Example measurements

Figure 9 below presents an example of the real-time and near-history utilization values over an Ethernet interface. From this figure it can be seen that both in and out utilizations values are at present 9.75 % and 3.86 % respectively. The graph shows that the utilization values have been relatively constant for at least 5 minutes, excluding the traffic drop at around 18:59:35. For the Ethernet link we can also see plenty of other performance indicators in this figure, most of them coming straight from the MIB specification and described above in section 4.2.2.

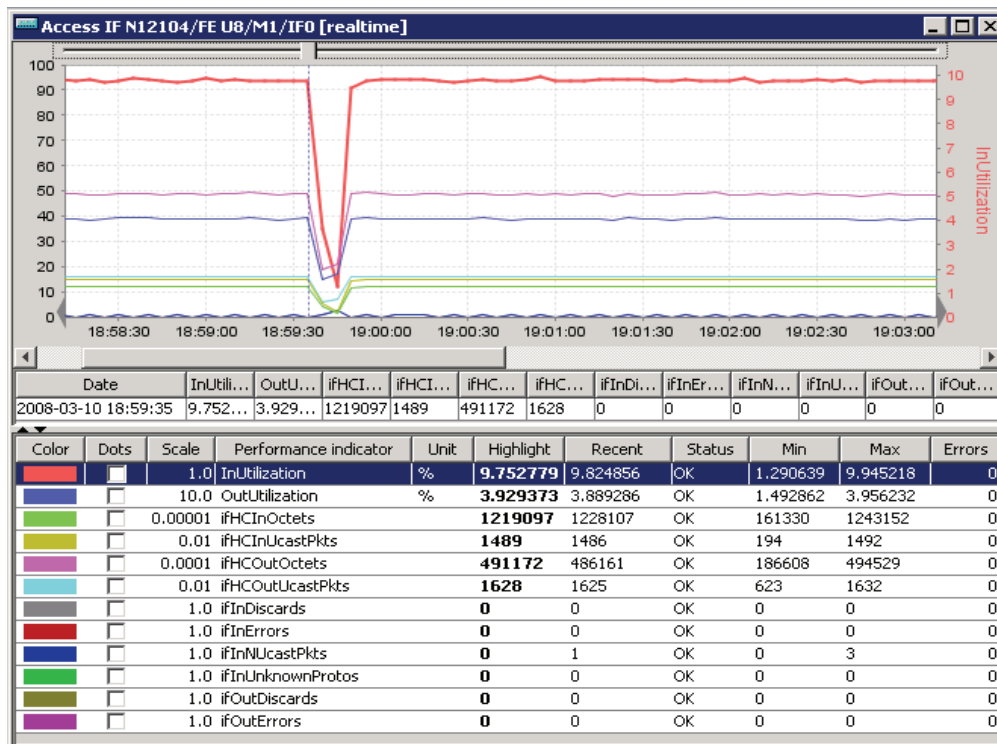

Figure 9. Ethernet interface performance indicators with historical and real-time monitoring.

Further examples of historical and real-time graphs with various other network technology interfaces can be found in Appendix A.

Figure 10 below shows a screenshot of the PMS overview window. This overview makes it possible to real-time monitor several links, trunks and interfaces from different nodes, such as in this example, it can be seen that there are now active ATM VP and VC, Ethernet as well as PPP interfaces. Appendix B contains a more detailed picture of the PMS overview.

Node	Interface	Util. in	Util. ou	Capacity	Category	Thresh. in %
	N12104					
S-30-104	N12104/ATM-VP U7/M1/ATM0/VP1-100	99.87	99.87	4.49 kcells/s	ATM VP	94
S-30-104	N12104/ATM-VP U7/M1/ATM0/VP1-60	91.20	47.88	4.49 kcells/s	ATM VP TERMINATED	-
S-30-104	N12104/ATM-VC U7/M1/ATM0/VP1.VCI-60.660	88.97	45.66	4.49 kcells/s	ATM_VC AAL5 IP	84
S-30-104	N12104/ATM U7/M1/ATM0	55.41	53.06	353.2 kcells/s	ATM	49
S-30-104	N12104/ATM U7/M1/ATM3	44.32	44.33	353.2 kcells/s	ATM	-
S-30-104	N12104/ATM U9/M1/ATM3	44.32	44.33	353.2 kcells/s	ATM	-
S-30-104	N12104/1G Eth U8/M0/IF1	13.54	13.16	1 Gbit/s	ETH_1G	-
S-30-104	N12104/FE U8/M1/IF0	12.89	13.18	100 Mbit/s	ETH_100M	-
S-30-104	N12104/PPP U7/M0/IF0	8.50	8.99	129 Mbit/s	PPP_VC4_POS	-
S-30-104	N12104/PPP U9/M0/IF0	8.50	8.99	129 Mbit/s	PPP_VC4_POS	-
S-30-104	N12104/1G Eth U8/M0/IF7	7.10	6.55	1 Gbit/s	ETH_1G	-
S-30-104	N12104/1G Eth U8/M0/IF0	5.82	6.03	1 Gbit/s	ETH_1G	-

Figure 10. PMS overview window with various different network technology interfaces.

## 5.5 Improvements in the near future

At Tellabs, the current investment in PMS development is relatively significant as there are at least three areas that need improving and developing. The first area of development covers the reporting capabilities of the system. At present, the user is only able to view the current and historical performance values per interface, or to use the performance overview window to view multiple interfaces, or to export the performance data to 3<sup>rd</sup> party applications. It would be useful, if the Tellabs PMS application could represent modified reports according to the user specifications. There could also be several example templates to be used. The reports could also be accessible by Internet, for example, by using XML interface for WWW pages.

The second area in need of improvement concerns the collecting and processing data. The most suitable method to collect and share the performance information should be investigated. For the collection, the options are either to use the SNMP or BMI protocols for these queries. As mentioned in the previous section, the BMI interface seems to be more efficient than SNMP, so using BMI is probably going to be more beneficial. Also, for the data collection, the technology specific OAM methods for performance queries should be investigated further. Finally for scalability of the system, the continuous data queries use the management network bandwidth, so the performance management platform in the network elements needs development to be more generic to reduce the bandwidth requirements of the queries.

Additionally, for the data storage some improvements need to be made, because the large data amounts consume much space in the database. One solution could be a dedicated database to hold all the performance data. Currently the Tellabs PMS uses the same database which contains all information related to the network elements as well as their configurations and also the information about the services provisioned in the managed networks. Since this database can be very large, the database queries from the shared database become quite slow. If it is not feasible to separate the database, some data compression would be recommended.

Additionally, an important improvement could be exporting the performance data to 3<sup>rd</sup> party applications. The Tellabs PMS could also make direct performance queries from 3<sup>rd</sup> party network devices. These queries could be handled directly from the network devices by standardized SNMP queries from the MIB objects or then using the technology specific OAM methods to query the performance information. On the one hand, if using the SNMP queries, the network element should then be managed by the Tellabs Network Manager and PMS. On the other hand, if the OAM methods would be used, then there could be made, for example, for an Ethernet connection, a throughput measurement query using the Ethernet OAM messages. The case could be, for example, a 3<sup>rd</sup> party Ethernet interface aggregating more Ethernet connections through a switch.



## **6 Performance management tool integration**

This chapter will discuss the process of performance management tool integration dealing with the benefits and disadvantages of this process. It will also make a small comparison between the current most commonly used performance management packages available from various vendors.

### **6.1 Tool integration process**

As performance management can be implemented on different levels, for example, for one Iu interface between the BTS and RNC, or for the whole access network including the core network, the integration between the different performance management systems and tools can become very important. Usually the whole network cannot be managed only by a single tool.

To implement the integration between different systems, there is a need for closely defining the interfaces between these systems. The major problem is the lack of specified standardizations or even recommendations for these interfaces. For this reason, the responsibility for interface implementation has recently been with the performance management system vendors.

The performance management system studied in this thesis is located on the mobile radio access transport network. This network can be said to begin from the mobile base station and to end in the Internet, or the operator's core network. Therefore, the system needs to handle the network interfaces between the following network elements:

- the base station and the BSC or RNC
- the BSC or RNC and the MSC or MGW
- the BSC or RNC and the SGSN

Additionally, the interface between the SGSN and GGSN can be covered, but in the majority of cases it can also be part of the Internet or the core network. Figure 11 has the different UTRAN architecture network elements with the interfaces between them (compare to Figure 1) and the performance management system coverage. The different

performance management systems are lettered from A to D. The PM systems B and C should have some integration between them, but also the PM system D, which is the umbrella system, should have integration with all other PM systems from A to C.

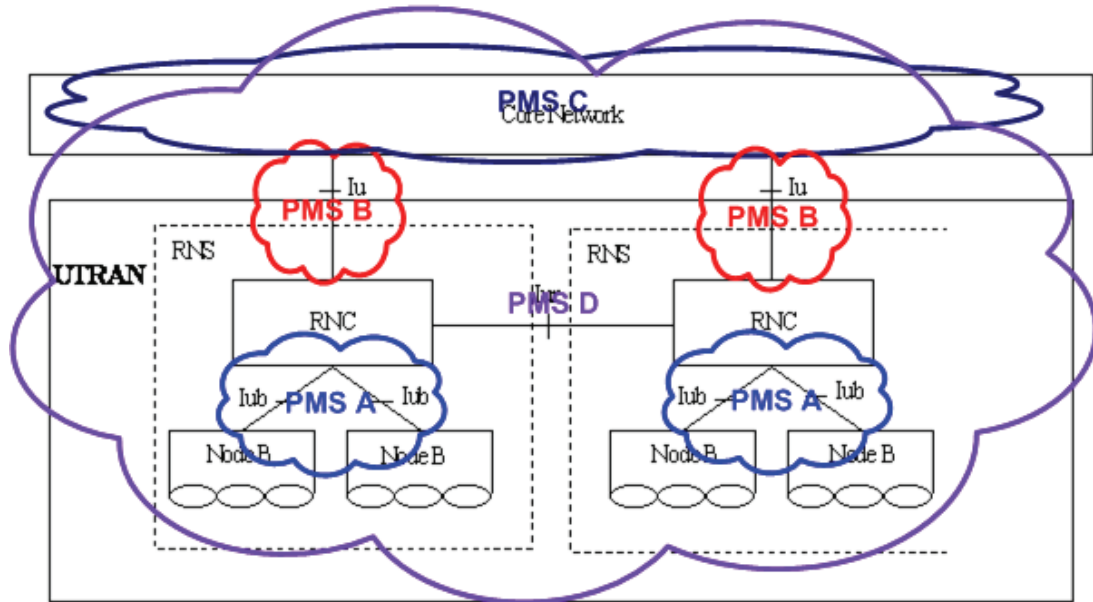

Figure 11. UTRAN architecture with A to D performance management systems.

As the interfaces between the different performance management systems are specified, a question arises how to collaborate the different performance management systems. Obviously, some common interfaces have to be developed to exchange the information. Usually, the performance management systems use some northbound interface formats, such as SNMP, CORBA and XML with common messages. Depending on the individual performance management system, the messages can still vary greatly, which is the reason for different PMS vendors for supporting integration with only limited number of other vendors. Also, this is why co-operation between the PMS vendors is very important in their development process. The operators want to use PMSs that are widely supported with other systems.

Another question is whether the data needed to be distributed between these systems is only the statistics or something extra. Moreover, there can be some other interfaces not

only to other performance management systems, but also to different network management systems. For example, these can be:

- Performance management
- Fault management
- Network element inventory
- Network topology
- Service provisioning

Also, if two or more tools are integrated, their roles in the wider management system need to be decided. The question is which tool will be the master tool and which other tools will act as the slaves. Usually the customers want only one tool to be used at the top of the system. As this master tool will present a larger picture of the network and it would ideally contain the best and most versatile reporting, as well as SLA verification capabilities. Additionally, it should have information of all failures and defects in the networks.

## **6.2 Various performance management tools**

The following section lists some commonly used performance management tools, which are carefully selected to see those that might be suitable for performance management in the mobile access networks. There are some main features of the tools in the list, according to the information of the white papers, data sheets and other product description materials from the tool vendors. A comparison is also made between them, and strong and weak features are presented for evaluation. Some of the tools are intended to be a higher level umbrella management system, and some of them are used only in small segments of the networks.

### **Tellabs – 8000 Network Manager Performance Management Package**

Tellabs PMS has been covered in the fifth chapter, thus it is not discussed in any detail here. It is usually used as an independent component to manage performance, for example, in the Iu or Iub interface. For comprehensive performance management, the

customers need some higher hierarchy performance management tool to act as the master. With the performance management systems from other vendors, as listed below, Tellabs PMS has partial integration process with IBM Tivoli Netcool Performance Management for Wireless, as well as with HP TeMIP.

### **InfoVista – VistaInsight for Networks**

VistaInsight provides management for real-time, historical and future network performance [INF08]. It supports many network technologies, such as IP/MPLS, Ethernet, ATM, Frame Relay and so on. The data collection is done via XML, SNMP or CSV files and the application supports network devices from many different vendors, for example, Cisco, Juniper, Nortel, Huawei and Alcatel-Lucent. The sample metrics and indicators can be divided to six categories:

- Real-time and historical utilization
- Response time and availability
- Submitted, transmitted and dropped traffic
- Latency, packet loss and jitter
- Errors in/out; smart utilization
- Time-to-capacity
- Saturation

VistaInsight also includes fault managing functions and powerful reporting capabilities.

### **CA – eHealth**

CA (formerly Concord) eHealth supports a large scale of network technologies and network services, for example, LAN, WAN, DSL, Wireless LAN, VoIP and QoS [EHE06]. Its basic function is to generate customized real-time performance management reports useful for locating possible problems in the networks. The data is collected by SNMP from the network elements, which have the MIB standardized performance data stored in them.

### **Packet Design – Traffic Explorer**

Traffic Explorer has two important managing features: route analytics and traffic flow analysis [PAC06]. It collects only NetFlow data from the network devices, which is a protocol for collecting IP traffic [RFC3954]. The main function of Traffic Explorer is to compute traffic flows across network topology using the routing data received from the Route Explorer application. Its reports contain information about the traffic and routing data, including service classes and application details.

### **Ericsson – ServiceOn**

Performance management in ServiceOn is just a functional area among other functions, like fault management and Ethernet and ATM managing [ERI08]. The performance management in ServiceOn supports historical and real-time performance monitoring with SLA validation. ServiceOn has quite good integration possibilities; it can be integrated into other operation support systems from various vendors, such as HP, IBM, InfoVista and Telcordia.

### **IBM – Tivoli Netcool Performance Manager for Wireless**

IBM Tivoli Netcool Performance Manager for Wireless, formerly known as Vallent NetworkAssure, is used to capture and analyze vital network metrics mostly from wireless networks [IBM07]. It can manage diverse technologies from multiple vendors by using standard integration capabilities. It has some preconfigured different wireless technologies technology packs, which give advantage from vendor-specific counters, key performance indicators, reports and graphs. The KPIs can also be predefined and customized from low-level measurements that include, for example, raw counters to higher level performance measurements across the business, for example, KPI for dropped calls.

The reports in Tivoli Netcool Performance Manager for Wireless are based on XML technology and they can also be exported as CSV or plain text files.

## **HP – TeMIP**

HP's TeMIP is more an operational support system platform [HP03] that supports the use of a large scale of different OSS applications, such as fault management, configuration and topology and performance management, all from this single system. Its graphical user interface includes topology presentations and network device alarm and state views. TeMIP supports standard protocols for network connectivity and other OSS integration, including, for example, SNMP, CORBA, database queries and XML.

## **Sonera – SurfManager**

Sonera SurfManager is a web-based interactive service and portal providing information for the customers that use Sonera's services [TEL08]. It provides some kind of SLA verification: the customers can check with SurfManager that the capacities of the services are properly dimensioned, the services are working as they should and also the maintenance is working well.

### **6.2.1 Summarizing the performance management tools**

To summarize the above mentioned commercial tools, it can be said that different performance management tools vary slightly with the following properties:

- Transport technology
  - o What layer 2 and 3 technologies does the tool cover?
  - o Does the tool cover only physical or logical links and interfaces?
- Data collection
  - o Does the tool make the performance data queries itself or does it need the performance data to be exported from other systems?
  - o What protocols does it use to collect data from the network elements?
- Management coverage
  - o At what level does the tool implement performance management?
  - o Does it manage only certain types of network elements from specific vendors?
  - o Does it manage only elements or the whole networks and its components?

- Tool coverage
  - Does the tool contain only performance management or also some connectivity testing and fault management?
  - What kind of reporting capabilities does the tool have?
  - Can the performance data and reports be exported to another system?
- Tool object
  - What kind of transport networks is the tool designed for?
  - Is it intended for mobile access, corporate access or core networks?
- Reporting
  - What kind of reports can the tool produce?
  - What formats the reports are and what kind of reporting technologies they use?
  - Are the reports portable into other systems?

By exploring different performance management systems and tools with the above questions, customers can more easily decide what systems and tools they implement in their networks. The main questions concerning usage are those related to performance management coverage and the reporting capabilities of the tool.

## **7 Dimensioning and optimizing the access networks**

This chapter discusses how mobile access networks should be designed and their traffic balanced based on the performance measurements. One problem to be handled is at what levels the management should be done. Also, it is necessary to study what options there really are for balancing this traffic. Additionally, some balancing at the radio network level will be investigated briefly.

### **7.1 Dimensioning and optimizing telecommunications networks**

Dimensioning and optimizing are two terms that are often used in the literature of the telecommunications network planning, where the purpose of this dimensioning is to ensure that the expected needs of both for subscribers and operators are to be met in an economical way [OLS98]. The dimensioning process has typically three phases: traffic measuring, traffic forecasting and traffic dimensioning. Traffic measuring can mean, for example, performance data collection or other OAM functions. By studying carefully the historical data growth and the forthcoming traffic needs, it is possible to forecast the likely volume of traffic. The dimensioning process itself is to add or change the capacity where it is needed most. And the basic function for dimensioning is to define the desired, usually minimum, capacity for the system to be able to ensure the desired level of service quality within a tolerable delay.

The purpose of optimizing telecommunications networks is to find a minimum or lowest cost for a specific network design [OLS98]. In other words, optimization means that all network resources are used more effectively. For example, if we have a network with only two links, where one has 50 % usability while the other has only 20 % usability, it is possible to optimize the network usage by routing all the traffic to one link. Thus we do not have to use the other link at all, making it free to be used for other purposes or networks.



Usually these dimensioning and optimizing processes are initiated due to the following reasons [SOL06]:

- New technologies, elements or features of particular network elements are taken into use.
- External edge conditions have changed.
- Detection of decreased QoS performance in a particular network area.
- As part of a daily network operation process.

## **7.2 Performance management in radio access networks**

If some kind of performance management system an operator wishes to use in the mobile access network, it should be made clear, which parts of the network will be covered by this single performance management system. It can cover only the interface between BTS / Node B and BSC / RNC, or it can also cover the whole transport network from BTS to the core network connected to the Internet, as in Figure 11 discussed in the previous chapter. For the different segments of the access networks, bottlenecks can appear in different places. That is why it is good to have performance management in operation in different levels: covering the transmission part in the access networks but also covering the larger network segment where the access networks are connected to the Internet.

Usually operators supervise their whole network from the base station all the way to the core network. If a single performance management system is to be used in the access network, from the base station to the radio network controller or beyond, this performance management system has to provide interfaces to a higher level performance management system that is covering a larger part of the network. Mobile operators have to select one performance management system to work as the master and then select one or more other systems to act as slaves. Operators usually have at least three different performance management systems, of which one is the umbrella or master system. The locations for the systems are:

- Air interface in the radio network

- Radio access network
- Core network

Additionally, the operator might have a fourth PM system that acts as the master system, as was modelled in Figure 11.

The basic usage scenarios of performance management at all network levels are the same: the operator needs to know how the network is functioning to measure the characteristics of the network. If the network does not function properly, the fault has to be identified and located. Whether the reason is a faulty unit or node, or incorrectly dimensioned network, the actions to remedy the fault need to be started relatively quickly. From this comes the reason for having various alarm and fault limits from fault management, indicating when some repair actions are needed.

If the mobile operator leased its transport network from a different transport network operator, there is a need to be able to verify the agreed Service Level Agreements, meaning usually that the leased lines, or pseudo wires, are working properly. Also, as mobile networks are converging more to the fixed networks, these SLAs become more and more important.

For example, one commonly used feature of performance management for the access networks is to verify the service level of aggregate TDM trunks, for example, E1 or T1 trunks, over the MPLS. If there is a threshold alarm for MPLS utilization and the alarm will generate a fault, this means that the utilization of the MPLS link has become dangerously high and no more of the TDM trunks should be aggregated into the MPLS link.

### **7.2.1 Network monitoring requirements**

The requirements for network monitoring are greatly dependent on the structure of the access network. The biggest variable, perhaps, is if the network segment is based on the circuit switched or packet switched transport technology.

For the packet switched networks, such as Ethernet, MPLS and IP networks, the five most important monitoring indicators in the access transport networks are [Y.1731]:

1. **One-way frame delay:** the time elapsed when the frame is sent from the transmitting network element to the receiving network element,
2. **One-way frame delay variation:** the difference between the one-way frame delays,
3. **Frame loss ratio:** the ratio of the number of undelivered frames divided by the number of all frames,
4. **Throughput:** the fastest rate the data can be sent,
5. **Network availability:** the percentage of the amount of time that the point-to-point connection is operational and is available to send and receive traffic.

From the above list, throughput and delay are perhaps the most important indicators for performance management systems, although, for the throughput measurements, the utilization is often more informative. When planning tolerable utilization values, the traffic diversity, which is a consequent of the different time scale busy hours, needs to be taken into account, as well as the possible forthcoming growth of data.

The tolerable transmission delays should also be carefully planned. These transmission delays vary greatly and are dependent on the used mobile radio technology and the particular mobile service. Usually, the transmission delays for the transport network should be rather small, since the user equipment and the RNC spend most of the delay budget. The end-to-end delays for the user and for the different packet mobile services are listed in Tables 4, 5 and 6 to be found in Chapter 2.

For circuit switched networks, the most important indicators are the bit error ratio and the connectivity. If the bit error ratio is dangerously high, for example, over 1 %, an alarm should be raised. Also, if there is no connectivity between the circuit endpoints, the network management system and maintenance should be notified.

## 7.2.2 Performance tool requirements

For a single performance management system or tool to be used in the access networks, not only the characteristics of the network, but also the requirements for the performance management tool need to be examined. There are at least four main

features that one performance management tool or system has to manage for the access networks:

- Practical performance indicators
- Reporting
- Integration with other tools and systems
- Fault management

The practical performance indicators come from the network requirements, as listed in the previous section. The tool or system should provide versatile indicators to monitor the performance, supporting the basic performance data collection standards, the important technology specific OAM methods as well as some useful performance indicator calculations. The most useful indicator in the access networks is network utilization.

The reports of the PM system should be clearly understandable and they should be easily exportable to some other PM systems or 3<sup>rd</sup> party applications, such as to some spreadsheet applications. The performance information and calculations should be kept in the database or in the network devices for long enough, so the operators could make versatile and also rather complex analyses from the performance data whenever they want to.

### **7.2.3 Using Tellabs 8000 PMS in the access networks**

For using Tellabs 8000 PM system in the access networks, Tellabs 8000 PMS concept has three main functions:

- Monitoring
- Planning
- Data collection

This concept can be seen in Figure 12 with the corresponding figures of the network elements, interfaces and the database. The three main functions together constitute the network utilization calculations that are the most important performance indicators in the access network, as learnt in the previous sections.

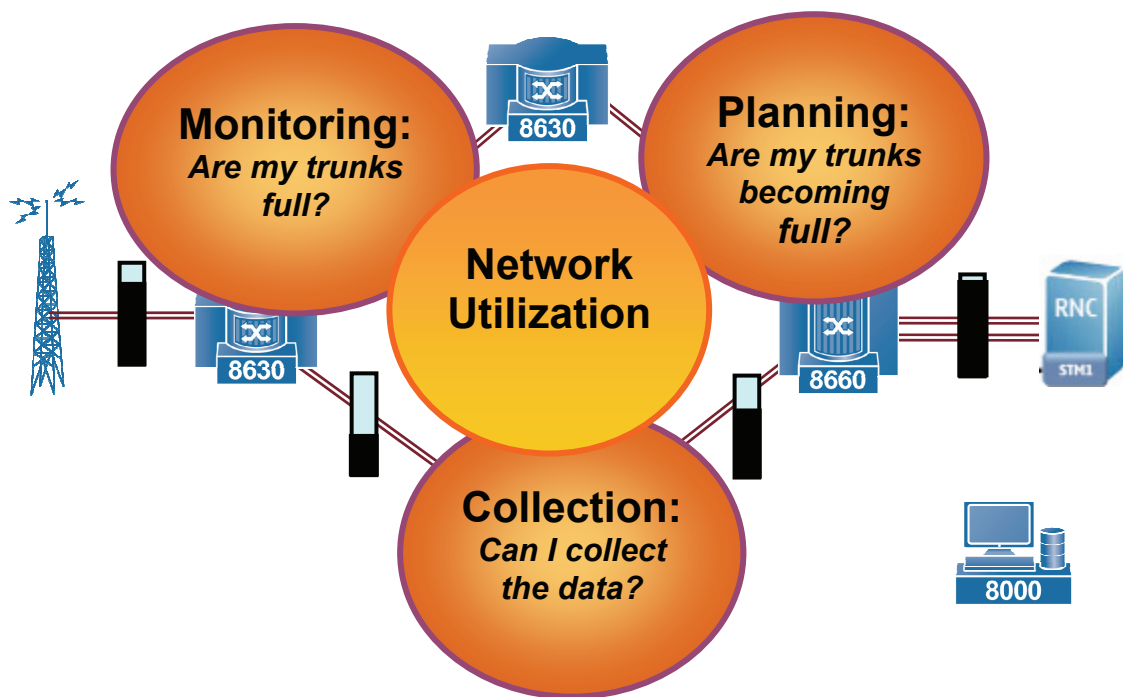

Figure 12. Tellabs 8000 PMS concept.

The monitoring of the trunks and links includes random monitoring of these links as well as possible faults and alarms of the link capacity or bit error ratio threshold exceeding utilization fault threshold, for example. The planning function includes the historical reports of various links where capacity or bit error ratio might become dangerously high. This can be achieved by using the PMS overview window, for example, which presents the dialog of ten worst trunks. The data collection function includes the polling policies and the abilities of the communication server to collect performance data from different network elements or other management systems or tools. Appendix B shows examples of the utilization fault, PMS overview and the polling policy dialog.

#### 7.2.4 Investment management

When using performance management in access networks, future investments can be planned better. Performance measurements can help answering two important questions:

- When to invest on additional capacity?
- Should the remaining capacity be leased to competitors?

Especially monitoring utilization trends in access networks can help answering these questions. A big decision in the process of leasing or investing apart from scheduling the transaction is the total expense of the investment or cost of leased capacity. The investments should be done when there are really no other options for balancing the traffic and when the investor can be sure that each investment is large enough to take care of immediate and predicted future needs for a particular network segment. There is really no point in increasing the capacity by 1 Megabit per a week, because every change in configuration and installation will cost extra money.

If the measurements can predict that there would be extra capacity in the long term (say one to two years), this extra capacity should be leased to other operators. In this case, own products or services should be made more attractive to win customers from competitors. Also, if capacity is running out and additional investments are unattractive, marketing of own products and services should be decreased.

It should be noted, that even a small increase of the capacity usually requires a visit to the cell site. Since operating expenses are more significant than capital expenses for mobile operators, they want to minimize these visits. When a site is visited, the capacity change should be large enough to cover the additional operating costs. This also limits the usage of performance management, because it always increases operating expenses with the costs of capital expenses. After all, the decision to use performance management is decided based on how profitable it is. The operators should identify the situations when to use PMS or alternatively to add more capacity. Using PMS increases operating costs while adding more capacity increases capital expenses.

### **7.3 Radio network traffic balancing**

The most common way to optimize network performance in mobile networks is to use handovers based on the load in the network. The load based handover is used for balancing the traffic load, for example, in the UMTS network between different

WCDMA layers or between the UMTS and GSM cellular networks [SOL06]. By way of example, when the operator notices that the utilization of the transport links in the GSM layer are becoming dangerously high, it can trigger the load based handover to switch some of the connections over to the UMTS network.

The other type of handover mechanism is referred to as service based handovers meaning that the handover is performed based on the services in the radio network [SOL06]. For instance, the operator knows that the traffic load is quite large in the affected area, based on the identification of the traffic, the operator can trigger the service based handover to hand over the voice service to the GSM network, while the data services are using the UMTS network.

Handovers are very useful and widely used traffic balancing method, but still they may not be able to balance the load in the access transport networks. For example, in the case when a handover is made between UMTS and GSM, both access networks might still use the same transport technology and network from node B to RNC or from BTS to BSC. An ATM or MPLS network might be, for example, the used transport solution for both UMTS and GSM.

#### **7.4 Other transport solutions**

One way to optimize network usage and increase available bandwidth is to use some other transport technologies and methods. Also, a dedicated mobile infrastructure presents a challenge from the point of view of costs, as the use of the circuit switched network technologies, is not that cost effective. Other good viable transport solutions could be Ethernet, DSL or some other hybrid solutions [AUG07]. Ethernet is naturally a good choice since it is rather cheap to implement and IP/MPLS can be transported over it. And as the sections dealing with transport technologies, MPLS makes it possible to encapsulate various other technologies. IP can be used if the network is transformed from switching to routing. In the cell sites that are geographically located in isolated

locations, the best advantage would be gained by using some DSL technology. The DSL could be used, for example, between the BTS and BSC.

Hybrid solutions probably offer the best solutions when migrating the legacy transport networks to newer technology or architecture, which are used especially in the next generation mobile networks. The hybrid approach for the transport network can be adopted by using the existing leased lines or circuit switched network for the legacy voice and real-time traffic, while using the affordable Ethernet based solutions for the high speed data packet traffic, like, for example, HSPA.

## **7.5 Traffic engineering**

The principles of Internet Traffic Engineering (TE) come from the Internet Society's RFC document 3272 [RFC3272]. The basic traffic engineering methods used in all kinds of telecommunications networks are, of course, applicable in mobile access networks. Careful study of the different TE methods shows that there are several methods suitable for use in mobile access transport networks. Some of the most important methods that are usable in access networks are described in the section below.

### **7.5.1 QoS differentiation**

By using packet scheduling based on the QoS schemes, the traffic in the transport network can be prioritized and differentiated. The most important mobile service, voice, could be used with the highest priority. If not using the simple priority scheduling for voice traffic, there should be performance monitoring and management to ensure that the delays and jitter of the voice traffic would not exceed the given limiting values. But in order to differentiate the traffic based on the service that is used, the performance management system should know which packets belong to which service. The easiest way for this is to separate the services to different service classes and to monitor those classes separately. The different service classes could be seen as separate logical connections in the performance management system. In the packet switched networks the performance management system should check every packet for its service class.



Also, all the network elements in the network segment should then support packet scheduling based on the service class.

### **7.5.2 Capacity reservation on the physical links**

In the MPLS networks, capacity can be reserved from the physical links with, for example, using the traffic engineering extension of the RSVP protocol (RSVP-TE). Usually, the capacities are reserved according to the maximum usage of the logical connection, like during the busy hour. This makes the capacity of the physical links underused and the system would prevent all new connections for reserving more bandwidth.

The network management or provisioning system, however, can support the overbooking method, allowing provisioning of more logical connections into the physical link. By estimating the future traffic requirements, for example, how much capacity the base stations would need, and studying the historical performance data from the current logical links, it should, therefore, be able to make a relatively good estimate of how much additional traffic the physical link can handle. When the estimate is done, the old connections could be re-provisioned with lesser capacity and all new connections could be provisioned by using the overbooking possibility. After the physical capacity has been reserved and divided more efficiently, the performance management system should be used for continuous monitoring of the utilization of the physical and logical links. If needed, the estimating and re-provisioning process could be repeated.

### **7.5.3 Other traffic engineering methods**

Some other TE methods could also be applicable for radio access transport networks, as they are applicable to other packet switched network used for other purposes. Some examples of these methods are traffic rerouting and the routing protocols' fast convergence. These methods are applicable only to TE-extended IP/MPLS networks.

## **7.6 Other dimensioning and optimizing solutions**

There might be several other good solutions for dimensioning and optimizing the access networks. The problem, however, is that recently operators have not had any reasons to investigate alternative solutions. This is largely because in the past the only good way to balance the network load has been to add more capacity to the network. As learnt from the introductory chapter, however, the need for additional capacity has increased rapidly and so too have the capacity costs. Operators should start to examine more ways of balancing the traffic, which includes network dimensioning and optimizing. Additionally, as the demand for versatile performance management systems and tools has increased, there needs to be found competent solutions from various vendors in the near future. Hopefully, different vendors will begin to work together to create better common standards for the PM system and tool integrations.

## **8 Summary and conclusions**

This chapter summarizes the thesis and makes some conclusions about the performance management in mobile networks, especially about the dimensioning and optimizing of networks with PM. Also included in this chapter, are some suggested areas for possible future research.

### **8.1 Summary of the thesis**

The rapid growth of mobile network traffic has created increased performance demands also for radio access transport networks. The growth of traffic has been a product of new mobile technologies, new pricing models from mobile operators as well as the bandwidth heavy mobile services that mobile users have increasingly started to use. This traffic growth has forced operators to redirect their planned additional capacity investments towards cheaper transport technologies such as Ethernet and MPLS. However, simply increasing the capacity is not very cost effective: it is far more beneficial to effectively balance the traffic load by using sophisticated dimensioning and optimizing methods in the mobile access transport networks.

The performance management system, alongside with other network management and OAM tools, is used for the management of the whole network. The network management process consists of the following steps: performance management and connectivity tests, fault management, network management and the actions of users all combined with SLA verification. These days, performance management systems and tools have become quite versatile, providing many performance indicators to help in the monitoring of network processes.

Many vendors have produced a wide variety of performance management systems and tools which differ in many ways, including the performance data collection, reporting, management coverage and the fault management capabilities. Tellabs 8000 Network Manager Performance Management Package is one that can be particularly used in

mobile access networks, having rather good performance data collection features as well as ease of integration to other systems.

Since operators usually run different PM systems in the different parts of the access and transport networks, performance management systems and tools integration has become a very important issue. The PM systems should provide common interfaces to exchange the performance, reporting and fault information between them.

Mobile network dimensioning and optimizing are good methods for balancing network load. To achieve this, reliable performance information of high quality is required. This includes detailed and informative historical reports, analysis of alarms and faults, as well as clear real-time monitoring capabilities.

For the dimensioning and optimizing process itself, there are a few good solutions available, including radio network traffic balancing, other transport solutions and many different traffic engineering methods. The most important TE methods for such purposes are QoS differentiation, additional capacity reservation as well as other traffic rerouting and convergence options.

Unfortunately, operators have usually only added more capacity when re-dimensioning and optimizing networks would be necessary. This is, perhaps, a reason for the lack of commonly available solutions to solve these problems. The operators should identify the situations when the use of PMS would be profitable, because in some cases it could also bring additional and unnecessary costs for them.

## **8.2 Conclusions**

After investigating all the possible dimensioning and optimizing methods for the mobile access networks, it was quite a surprise to learn that many operators have done very little dimensioning work, and no optimizing at all. Even if the capacity demands for the transport networks have been constantly growing, the solution has always only been to add more capacity to the network. There are, however, some common solutions available for balancing the traffic, but implementing them to access networks remains quite a challenge as not all of them are applicable to next evolution mobile networks.

Additionally, the development work of any new solutions to remedy the problem is equally challenging. Some answer to the problem is necessary and it is only a matter of time before the market realizes that an effective PM system is needed to balance network traffic instead of investing always on the additional capacity. Efficient and reasonable usage of performance management will balance operating and capital expenses.

Already it is clear that some pioneering operators have started to see the potential on the dimensioning and optimizing process, and new performance management systems and tools from different vendors are entering the markets all the time. Hopefully, this will lead to the availability of good solutions to the problem in the near future.

For one performance management system to be successful, it will need to have good supporting and integrating features to numerous different systems and tools from other vendors. This will require more standardization work to develop common interfaces between the systems. Also, not only the performance management functionality will be enough, as the system should provide various other OAM functions, like fault management, reporting and, for example, SLA verification.

For the OAM functions, there are many specifications for different network technologies' OAM capabilities. In any case, it is disappointing that the performance related functions are not used widely. By implementing the OAM functions into performance management systems, the features of the system could be extended also to cover, for example, connectivity and far-end polling capabilities.

### **8.3 Recommendations for further study**

There are at least three major areas where the additional study and research could be carried out. The first concerns the OAM functions usage in performance management. The different functions and capabilities could be studied to see, whether they could help in the performance information polling, in the checking the connectivity of the connection, as well as in other functions that require operations and maintenance.

The second area could be related to performance system integration. Integration of both similar and different kinds of systems could be investigated to see how one could act as the master system and what common interfaces would be required. In particular, the integration of other tools into a single system should be researched further. These tools include fault management, connectivity and other OAM tests, reporting capabilities and, of course, SLA verification.

The last and most important area of further study could be the implementation of the dimensioning and optimizing solutions into the access networks. Areas studied could be how the performance management systems help in network planning, whether they could be used in the access networks, and what kind of information would be required to get out from the system for dimensioning and optimizing purposes. Additionally, there should be more investigation into the different dimensioning and optimizing solutions, and there would be a need to study which of these solutions would be especially applicable in the mobile access networks of the future.

## References

- [1588v2] IEEE Standard 1588 version 2, *Standard for a Precision Clock Synchronization Protocol for Networked Measurement and Control Systems*, November 2002
- [22.105] 3GPP Technical Specification 22.105-840, *Services and service capabilities (Release 8)*, June 2007  
<http://www.3gpp.org/ftp/Specs/html-info/22105.htm>
- [23.107] 3GPP Technical Specification 23.107-710, *Quality of Service (QoS) concept and architecture*, September 2007  
<http://www.3gpp.org/ftp/Specs/html-info/23107.htm>
- [25.401] 3GPP Technical Specification 25.401-740, *UTRAN Overall Description*, June 2007  
<http://www.3gpp.org/ftp/Specs/html-info/25401.htm>
- [25.430] 3GPP Technical Specification 25.430-750, *Utran Iub interface: general aspects and principles*, September 2007  
<http://www.3gpp.org/ftp/Specs/html-info/25430.htm>
- [32.111-1] 3GPP Technical Specification 32.111-1-700, *Telecommunication Management; Fault Management; Part 1: 3G fault management requirements*, June 2007  
<http://www.3gpp.org/ftp/Specs/html-info/32111-1.htm>
- [32.401] 3GPP Technical Specification 32.401-710, *Telecommunication Management; Performance Management (PM); Concept and requirements*, December 2007  
<http://www.3gpp.org/ftp/Specs/html-info/32401.htm>

- [8000NM] Tellabs 8000 Network Manager, Data Sheet, *A Powerful Network and Service Management Tool*, January 2007  
<http://www.tellabs.com/products/8000/tlab8000nm.pdf>
- [8000PMS] Tellabs 8000 Network Manager, Data Sheet, *Performance Management Package*, November 2006  
<http://www.tellabs.com/products/8000/tlab8000nmperfmgmtpkg.pdf>
- [802.1p] IEEE Computer Society, Standard 802.1p, *Standard for Local and Metropolitan Area Networks-Supplement to Media Access Control (MAC) Bridges: Traffic Class Expediting and Dynamic Multicast Filtering*, September 1995
- [AF-0121] The ATM Forum Technical Committee AF-TM-0121.000, *Traffic Management Specification Version 4.1*, March 1999  
<http://www.ipmplsforum.org/ftp/pub/approved-specs/af-tm-0121.000.pdf>
- [AF-0150] The ATM Forum Technical Committee AF-TM-0150.000, *Addendum to Traffic Management V4.1 for an Optional Minimum Desired Cell Rate Indication for UBR*, July 2000  
[http://www.ipmplsforum.org/tech/atm\\_specs.shtml](http://www.ipmplsforum.org/tech/atm_specs.shtml)
- [AUG07] Augustin, J., *Mobile Backhaul Evolution Towards FMC and LTE*. Tellabs internal presentation, 2007
- [BAN04] Bannister, J., Mather P., Coope S. *Convergence Technologies for 3G Networks: IP, UTMS, EGPRS and ATM*. West Suxxes, John Wiley & Sons Inc., 2004



- [BRO07a] Brown, G. Evolved HSPA & the Roadmap to LTE. *Unstrung Insider*, 2007, vol. 6, no 10
- [BRO07b] Brown, G. Flat IP Architectures for Mobile Networks. *Unstrung Insider*, 2007, vol. 6, no 6
- [CIS8603] Cisco Systems, Inc. Tech Notes, Document ID 8603. *Understanding the UBR+ Service Category for ATM VCs*, April 2006  
<http://www.cisco.com/warp/public/121/ubrplus.html>
- [E.880] ITU-T Recommendation E.880, *Field data collection and evaluation on the performance of equipment, networks and services*, November 1988  
<http://www.itu.int/rec/T-REC-E.880/en>
- [EHE06] eHealth E2E Console, Data Sheet, 2006  
[http://www.ca.com/files/DataSheets/ehealth\\_e2e\\_console\\_ds\\_en\\_us.pdf](http://www.ca.com/files/DataSheets/ehealth_e2e_console_ds_en_us.pdf)
- [ERI07] Eriksson, H. Presentation at *Ericsson Strategy & Technology Summit*, London, September 11<sup>th</sup> 2007. Referenced February 18<sup>th</sup> 2008  
[http://www.ericsson.com/ericsson/investors/events/2007/doc/HE\\_ST\\_07\\_SHOW.pdf](http://www.ericsson.com/ericsson/investors/events/2007/doc/HE_ST_07_SHOW.pdf)
- [ERI08] Ericsson ServiceOn Data Release 3.3, Data Sheet, *Total Control of Your Data Network*, 2008  
[http://www.ericsson.com/solutions/products/literature/ServiceOn\\_Data\\_literature.shtml](http://www.ericsson.com/solutions/products/literature/ServiceOn_Data_literature.shtml)
- [G.775] ITU-T Recommendation G.775, *Loss of Signal (LOS), Alarm Indication Signal (AIS) and Remote Defect Indication (RDI) defect detection and clearance criteria for PDH signals*, October 1998  
<http://www.itu.int/rec/T-REC-G.775/en>

- [G.805] ITU-T Recommendation G.805, *Generic functional architecture of transport networks*, March 2000  
<http://www.itu.int/rec/T-REC-G.805/en>
- [GIN99] Ginsburg, D. *ATM – solutions for enterprise interworking*. 2<sup>nd</sup> Edition. Essex, Addison Wesley Longman, 1999
- [HP03] HP OpenView TeMIP Framework, 2003  
<http://www.hp.com>
- [HOR03] Horváth, G., Vulkán, C., *Analytical 3G RAN Transport Network Modeling with Calipran*, published in Proc. of the 11th Microcoll, Budapest, Hungary, September 2003
- [IBM07] IBM Tivoli Netcool Performance Manager for Wireless, White Paper, 2007  
<ftp://ftp.software.ibm.com/software/tivoli/whitepapers/TID10381-USEN-00.pdf>
- [INF08] InfoVista VistaInsight for Networks, Data Sheet, *Business-Aligned Insight into Real-Time, Historical and Future Network Performance*, January 2008  
[http://www.infovista.com/Portals/0/pdf/DS\\_InfoVista\\_VistaInsight\\_for\\_Networks\\_ENT.pdf](http://www.infovista.com/Portals/0/pdf/DS_InfoVista_VistaInsight_for_Networks_ENT.pdf)
- [I.610] ITU-T Recommendation I.610, *B-ISDN operation and maintenance principles and functions*, February 1999  
<http://www.itu.int/rec/T-REC-I.610/en>

- [JAC05] Jackson, T. *Examining Packet Requirements in 3G Radio Access Networks*, Presentation at IIR Transport Networks for Mobile Operators, Vienna, May 9<sup>th</sup> 2005
- [MIC05] Micali, R. *Determining a technical roadmap for the evolution from ATM to IP transport for 3G networks*, Presentation at IIR Transport Networks for Mobile Operators, Vienna, May 10<sup>th</sup> 2005
- [MOM07] Momtahan, P. *The Business Case for Pseudowires in the RAN*, Tellabs White Paper, 2007  
<http://www.tellabs.com/papers/tlabpseudowireran.pdf>
- [OHT06] Ohta, H., *Ethernet OAM and Protection Switching*, Presentation at ITU-T Workshop “NGN and its Transport Networks”, Kobe, 20-21<sup>th</sup> April 2006  
[http://www.itu.int/ITU-T/worksem/ngn/200604/presentation/s7\\_ohta.pdf](http://www.itu.int/ITU-T/worksem/ngn/200604/presentation/s7_ohta.pdf)
- [OLS98] Olsson, A, editor. *Understanding Telecommunications 1*. Lund, Ericsson Telecom, Telia and Studentlitteratur, 1998
- [PAC06] Packet Design Traffic Explorer, Data Sheet, *Harnessing the Intelligence of IP*, September 2006  
[http://www.packetdesign.com/documents/TrafficExplorer\\_Datasheet\\_v2.0.pdf](http://www.packetdesign.com/documents/TrafficExplorer_Datasheet_v2.0.pdf)
- [RFC1155] Rose, M., McCloghrie, K., *Structure and Identification of Management Information for TCP/IP-based Internets*, IETF RFC 1155, May 1990  
<http://www.ietf.org/rfc/rfc1155.txt>

- [RFC1213] McCloghrie, K., Rose, M., *Management Information Base for Network Management of TCP/IP-based internets: MIB-II*, IETF RFC 1213, March 1991  
<http://www.ietf.org/rfc/rfc1213.txt>
- [RFC2474] Nichols, K., Blake, S., Baker, F., Black, D., *Definition of the Differentiated Services Field (DS Field) in the IPv4 and IPv6 Headers*, IETF RFC 2474, December 1998  
<http://www.ietf.org/rfc/rfc2474.txt>
- [RFC2544] Bradner, S., McQuaid J., *Benchmarking Methodology for Network Interconnect Devices*, IETF RFC 2544, March 1999  
<http://www.ietf.org/rfc/rfc2544.txt>
- [RFC3270] Le Flaucher, F., *Multi-Protocol Label Switching (MPLS) Support of Differentiated Services*, IETF RFC 3270, May 2002  
<http://www.ietf.org/rfc/rfc3270.txt>
- [RFC3272] Awduche, D., Chiu, A., Elwalid, A., Widjaja, I., Xiao, X., *Overview and Principles of Internet Traffic Engineering*, IETF RFC 3272, May 2002  
<http://www.ietf.org/rfc/rfc3272.txt>
- [RFC3606] Ly, F., Noto, M., Smith, A., Spiegel, E., Tesink, K., *Definitions of Supplemental Managed Objects for ATM Interface*, IETF RFC 3606, November 2003  
<http://www.ietf.org/rfc/rfc3606.txt>
- [RFC3954] Claise, B., *Cisco Systems NetFlow Services Export Version 9*, IETF RFC 3954, October 2004  
<http://www.ietf.org/rfc/rfc3954.txt>

- [RFC3985] Bryant, S., Pate, P., *Pseudo Wire Emulation Edge-to-Edge (PWE3) Architecture*, IETF RFC 3985, March 2005  
<http://www.ietf.org/rfc/rfc3985.txt>
- [SOL06] Soldani, D., Li, M., Cuny R., *QoS and QoE Management in UMTS Cellular Systems*. West Sussex, John Wiley & Sons Inc., 2006
- [TEL08] TeliaSonera Sonera SurfManager WWW pages. Referenced March 4<sup>th</sup> 2008  
<http://www.sonera.fi/Yrityksille/Hallinta/Laskutus,+hallinnointi+ja+raportointi/SurfManager>
- [WAL07] Wallström, M., *Automation of Mobile Radio Network Performance and Fault Management*, Master's Thesis, Helsinki University of Technology 2007
- [WIR07] Wireless Intelligence. *GSM Subscriber Quarterly Statistics – Q1 2007*. Referenced February 18<sup>th</sup> 2008  
[http://www.gsmworld.com/news/statistics/pdf/gsma\\_stats\\_q1\\_07.pdf](http://www.gsmworld.com/news/statistics/pdf/gsma_stats_q1_07.pdf)
- [Y.1711] ITU-T Recommendation Y.1711, *Operation & Maintenance mechanism for MPLS networks*, February 2004  
<http://www.itu.int/rec/T-REC-Y.1711/en>
- [Y.1731] ITU-T Recommendation Y.1731, *OAM functions and mechanisms for Ethernet based networks*, May 2006  
<http://www.itu.int/rec/T-REC-Y.1731/en>

## Appendix A

This appendix includes graphical and numerical views of real-time and historical performance information from different network interfaces. These interfaces include RSVP tunnel, ATM IMA interface, STM1 ATM interface and PPP interface

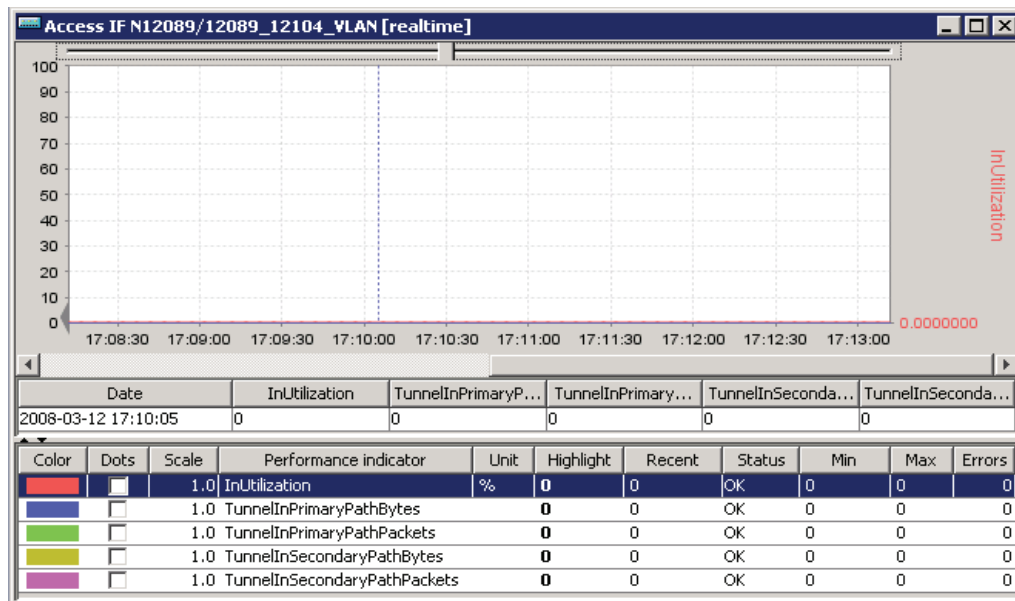

Figure 1. RSVP-tunnel.

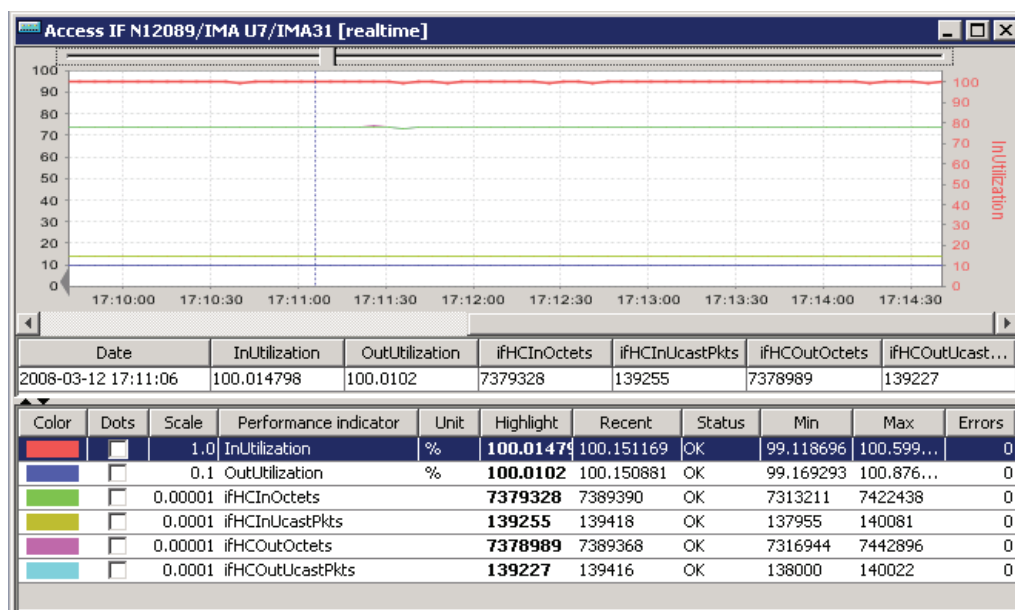

Figure 2. ATM IMA interface.

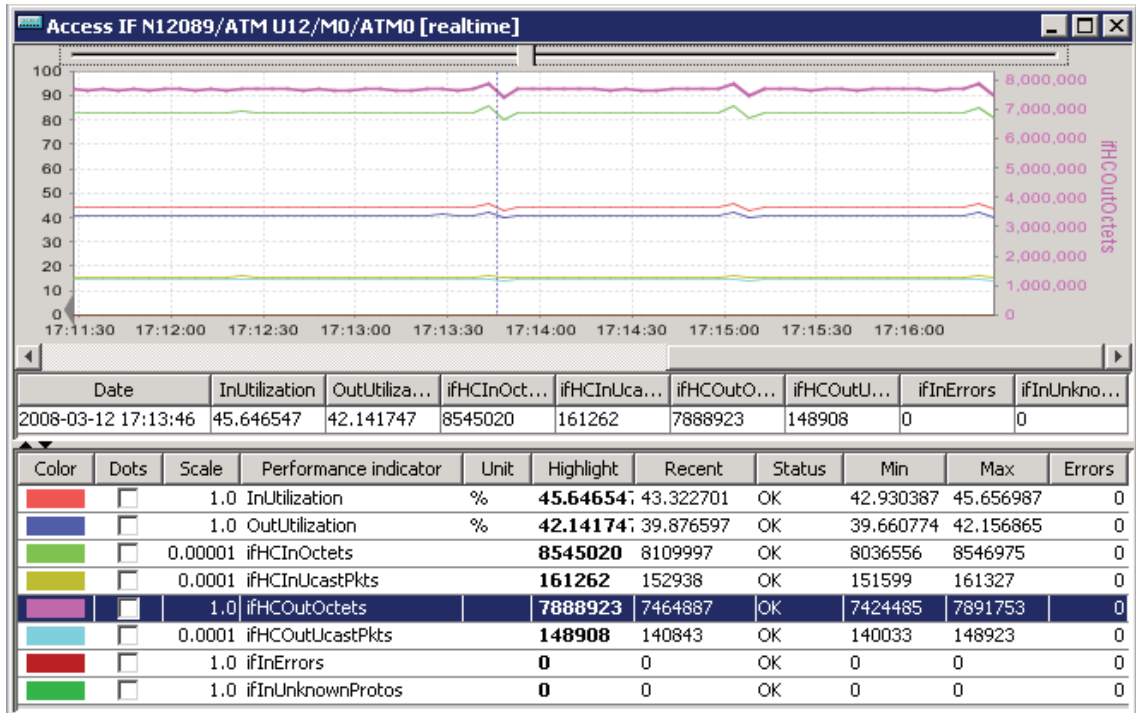

Figure 3. STM1 ATM interface.

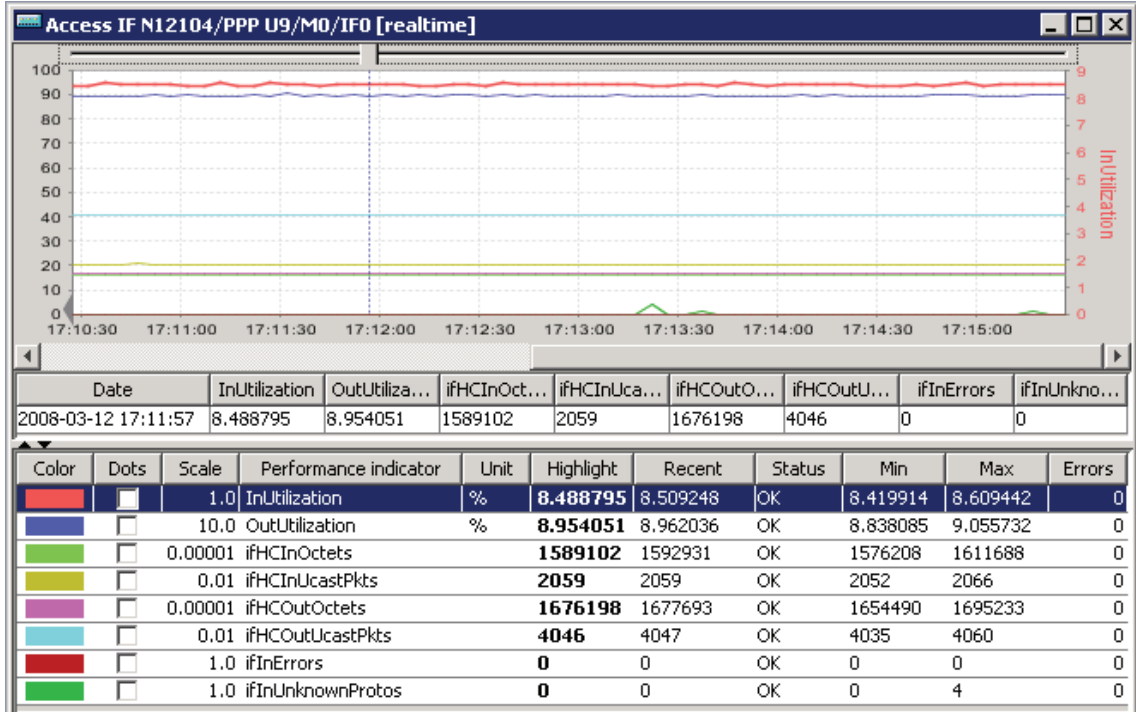

Figure 4. PPP interface.

## Appendix B

This appendix includes various dialogs from Tellabs 8000 Network Manager Performance Management Package.

Performance Management Configuration for Database

8600 configuration | 8100 configuration | SLA server configuration

Ageing daily scheduling [HH MM]: 11 10

MIB	History Ageing days	Interval history Calculation Ageing days	Utilization faults Ageing days	Database size MB Current MB
MIB-II:	12	<input checked="" type="checkbox"/> Enable 11	<input checked="" type="checkbox"/> Enable	39,431
ATM2:	14	<input checked="" type="checkbox"/> Enable 14	<input checked="" type="checkbox"/> Enable	161,101
MPLS TE:	14	<input checked="" type="checkbox"/> Enable 14	<input checked="" type="checkbox"/> Enable	5,941
FR DTE:	14	<input checked="" type="checkbox"/> Enable 14	<input checked="" type="checkbox"/> Enable	0,73
PWE:		<input checked="" type="checkbox"/> Enable 14		0,388
PWE3 TDM:		<input checked="" type="checkbox"/> Enable 14		0,093
TDM/ 15 min:		<input checked="" type="checkbox"/> Enable 14		4,82
TDM/ 24 h:		<input checked="" type="checkbox"/> Enable 14		

---

Ageing days Collection Periodic polling [HH MM] Database size MB

Polling log: 14  Enable 0 15 4,509

Total database size

Current MB	Estimate MB
217,017	0,0

Update Close Help... About...

Figure 1. A PM configuration dialog from Tellabs 8000 Network Manager Performance Management Package. The dialog makes possible to set polling and history policies.



Nr	Node ID	Fault source	Problem description	Specifier	Alarming object	On-time (-)
1	12104	Interface Unit 1-A N12104/U7	Outgoing utilization threshold crossed	Comm: Utilization 345.83%, threshold 100%	ATM-VC U7/M1/ATM0/VPI.VCI-254.65010	2008-03-12 10:56:16
2	12104	Interface Unit 1-A N12104/U7	Incoming utilization threshold crossed	Comm: Utilization 548.62%, threshold 100%	ATM-VC U7/M1/ATM0/VPI.VCI-254.65010	2008-03-12 10:56:16
4	12104	Interface Unit 1-A N12104/U7	Incoming utilization threshold crossed	Comm: Utilization 275.72%, threshold 100%	ATM-VP U7/M1/ATM0/VPI-255	2008-03-12 10:56:15
3	12104	Interface Unit 1-A N12104/U7	Outgoing utilization threshold crossed	Comm: Utilization 174.18%, threshold 100%	ATM-VP U7/M1/ATM0/VPI-255	2008-03-12 10:56:15
5	12104	Interface Unit 1-A N12104/U7	Outgoing utilization threshold crossed	Comm: Utilization 53.14%, threshold 45%	ATM U7/M1/ATM0	2008-03-12 10:53:14
6	12104	Interface Unit 1-A N12104/U7	Incoming utilization threshold crossed	Comm: Utilization 55.49%, threshold 49%	ATM U7/M1/ATM0	2008-03-12 10:53:14
7	12104	Interface Unit 1-A N12104/U7	Outgoing utilization threshold crossed	Comm: Utilization 498.79%, threshold 100%	ATM-VC U7/M1/ATM0/VPI.VCI-254.65010	2008-03-12 10:51:16
8	12104	Interface Unit 1-A N12104/U7	Incoming utilization threshold crossed	Comm: Utilization 797.8%, threshold 100%	ATM-VC U7/M1/ATM0/VPI.VCI-254.65010	2008-03-12 10:51:16
9	12104	Interface Unit 1-A N12104/U7	Outgoing utilization threshold crossed	Comm: Utilization 45.53%, threshold 41%	ATM-VC U7/M1/ATM0/VPI.VCI-60.660	2008-03-12 10:51:16
10	12104	Interface Unit 1-A N12104/U7	Incoming utilization threshold crossed	Comm: Utilization 88.76%, threshold 84%	ATM-VC U7/M1/ATM0/VPI.VCI-60.660	2008-03-12 10:51:16
11	12104	Interface Unit 1-A N12104/U7	Outgoing utilization threshold crossed	Comm: Utilization 99.62%, threshold 94%	ATM-VC U7/M1/ATM0/VPI.VCI-70.100	2008-03-12 10:51:16
12	12104	Interface Unit 1-A N12104/U7	Incoming utilization threshold crossed	Comm: Utilization 99.62%, threshold 94%	ATM-VC U7/M1/ATM0/VPI.VCI-70.100	2008-03-12 10:51:16
13	12104	Interface Unit 1-A N12104/U7	Outgoing utilization threshold crossed	Comm: Utilization 249.98%, threshold 100%	ATM-VP U7/M1/ATM0/VPI-255	2008-03-12 10:51:15
14	12104	Interface Unit 1-A N12104/U7	Incoming utilization threshold crossed	Comm: Utilization 399.50%, threshold 100%	ATM-VP U7/M1/ATM0/VPI-255	2008-03-12 10:51:15
15	12104	Interface Unit 1-A N12104/U7	Outgoing utilization threshold crossed	Comm: Utilization 99.55%, threshold 94%	ATM-VP U7/M1/ATM0/VPI-100	2008-03-12 10:51:15
16	12104	Interface Unit 1-A N12104/U7	Incoming utilization threshold crossed	Comm: Utilization 99.55%, threshold 94%	ATM-VP U7/M1/ATM0/VPI-100	2008-03-12 10:51:15
17	12104	Interface Unit 1-A N12104/U7	Outgoing utilization threshold crossed	Comm: Utilization 52.99%, threshold 45%	ATM U7/M1/ATM0	2008-03-12 10:48:15
18	12104	Interface Unit 1-A N12104/U7	Incoming utilization threshold crossed	Comm: Utilization 55.34%, threshold 49%	ATM U7/M1/ATM0	2008-03-12 10:48:15
21	12104	Interface Unit 1-A N12104/U7	Outgoing utilization threshold crossed	Comm: Utilization 45.85%, threshold 41%	ATM-VC U7/M1/ATM0/VPI.VCI-60.660	2008-03-12 10:46:15
22	12104	Interface Unit 1-A N12104/U7	Incoming utilization threshold crossed	Comm: Utilization 88.97%, threshold 84%	ATM-VC U7/M1/ATM0/VPI.VCI-60.660	2008-03-12 10:46:15
23	12104	Interface Unit 1-A N12104/U7	Outgoing utilization threshold crossed	Comm: Utilization 99.86%, threshold 94%	ATM-VC U7/M1/ATM0/VPI.VCI-70.100	2008-03-12 10:46:15
24	12104	Interface Unit 1-A N12104/U7	Incoming utilization threshold crossed	Comm: Utilization 99.86%, threshold 94%	ATM-VC U7/M1/ATM0/VPI.VCI-70.100	2008-03-12 10:46:15
25	12104	Interface Unit 1-A N12104/U7	Outgoing utilization threshold crossed	Comm: Utilization 250.15%, threshold 100%	ATM-VP U7/M1/ATM0/VPI-255	2008-03-12 10:46:15
26	12104	Interface Unit 1-A N12104/U7	Incoming utilization threshold crossed	Comm: Utilization 399.66%, threshold 100%	ATM-VP U7/M1/ATM0/VPI-255	2008-03-12 10:46:15
19	12104	Interface Unit 1-A N12104/U7	Outgoing utilization threshold crossed	Comm: Utilization 499.97%, threshold 100%	ATM-VC U7/M1/ATM0/VPI.VCI-254.65010	2008-03-12 10:46:15
20	12104	Interface Unit 1-A N12104/U7	Incoming utilization threshold crossed	Comm: Utilization 798.95%, threshold 100%	ATM-VC U7/M1/ATM0/VPI.VCI-254.65010	2008-03-12 10:46:15
27	12104	Interface Unit 1-A N12104/U7	Outgoing utilization threshold crossed	Comm: Utilization 100.24%, threshold 94%	ATM-VP U7/M1/ATM0/VPI-100	2008-03-12 10:46:14

Fault count: 8682

Figure 2. Several utilization faults from Tellabs 8000 Network Manager Fault Management Package.

Node	Interface	Util. in	Util. o	Reliabil	Capacity	Category	Util. cap.	Thresh. in %	Layer	AT	A	V
S-30-104	N12104											
S-30-104	N12104/ATM-VP U9/M1/ATM3/VPI-246	19.55	19.57	100.00	34.93 kcells/s	ATM VP	-	-	-	-	-	-
S-30-104	N12104/ATM-VP U7/M1/ATM0/VPI-250	19.54	19.56	100.00	22.56 kcells/s	ATM VP TERMINATED	-	-	-	-	-	-
S-30-104	N12104/ATM-VP U7/M1/ATM0/VPI-249	19.54	19.56	100.00	7.781 kcells/s	ATM VP TERMINATED	-	-	-	-	-	-
S-30-104	N12104/ATM-VP U7/M1/ATM0/VPI-248	19.54	19.56	100.00	38.98 kcells/s	ATM VP	-	-	-	-	-	-
S-30-104	N12104/ATM-VP U7/M1/ATM0/VPI-246	19.54	19.56	100.00	34.93 kcells/s	ATM VP	-	-	-	-	-	-
S-30-104	N12104/ATM-VP U9/M1/ATM3/VPI-71	19.53	19.54	100.00	2.9 kcells/s	ATM VP TERMINATED	-	-	-	-	-	-
S-30-104	N12104/ATM-VP U9/M1/ATM3/VPI-101	19.52	19.54	100.00	4.49 kcells/s	ATM VP	-	-	-	-	-	-
S-30-104	N12104/ATM-VP U7/M1/ATM0/VPI-70	19.52	19.54	100.00	2.9 kcells/s	ATM VP TERMINATED	-	-	-	-	-	-
S-30-104	N12104/ATM-VP U7/M1/ATM0/VPI-50	19.52	19.54	100.00	1 kcells/s	ATM VP TERMINATED	-	-	-	-	-	-
S-30-104	N12104/ATM-VP U7/M1/ATM0/VPI-210	19.52	18.81	100.00	5.01 kcells/s	ATM VP	-	-	-	-	-	-
S-30-104	N12104/ATM-VP U7/M1/ATM0/VPI-60	17.82	6.37	100.00	4.49 kcells/s	ATM VP TERMINATED	-	-	-	-	-	-
S-30-104	N12104/ATM U7/M1/ATM0	12.74	11.72	100.00	353.2 kcells/s	ATM	353.2 kcells/s	49	-	-	-	-
S-30-104	N12104/ATM U9/M1/ATM3	8.63	8.66	100.00	353.2 kcells/s	ATM	-	-	-	-	-	-
S-30-104	N12104/ATM U7/M1/ATM3	8.62	8.66	100.00	353.2 kcells/s	ATM	-	-	-	-	-	-
S-30-104	N12104/1G Eth U8/M0/IF1	4.45	3.28	100.00	1 Gbit/s	ETH_1G	-	-	-	-	-	-
S-30-104	N12104/FE U8/M1/IF0	2.41	0.96	100.00	100 Mbit/s	ETH_100M	-	-	-	-	-	-
S-30-104	N12104/1G Eth U8/M0/IF7	1.75	0.84	100.00	1 Gbit/s	ETH_1G	-	-	-	-	-	-
S-30-104	N12104/Rev12089_12104_STM4POS	1.70	-	100.00	10 Mbit/s	TE_TUNNEL	-	-	-	-	-	-
S-30-104	N12104/ATM-VP U7/M1/ATM0/VPI-61	0.43	0.43	100.00	4.49 kcells/s	ATM VP TERMINATED	-	-	-	-	-	-
S-30-104	N12104/ATM-VP U9/M1/ATM3/VPI-61	0.43	0.43	100.00	4.49 kcells/s	ATM VP TERMINATED	-	-	-	-	-	-
S-30-104	N12104/ATM-VP U9/M1/ATM3/VPI-60	0.43	0.43	100.00	4.49 kcells/s	ATM VP TERMINATED	-	-	-	-	-	-
S-30-104	N12104/1G Eth U8/M0/IF0	0.14	0.45	100.00	1 Gbit/s	ETH_1G	-	-	-	-	-	-
S-30-104	N12104/ATM-VP U9/M1/ATM3/VPI-49	0.06	0.00	100.00	20 cells/s	ATM VP	-	-	-	-	-	-
S-30-104	N12104/ATM-VP U9/M1/ATM3/VPI-48	0.06	0.00	100.00	20 cells/s	ATM VP	-	-	-	-	-	-
S-30-104	N12104/ATM-VP U9/M1/ATM3/VPI-47	0.06	0.00	100.00	20 cells/s	ATM VP	-	-	-	-	-	-
S-30-104	N12104/ATM-VP U9/M1/ATM3/VPI-46	0.06	0.00	100.00	20 cells/s	ATM VP	-	-	-	-	-	-
S-30-104	N12104/ATM-VP U9/M1/ATM3/VPI-45	0.06	0.00	100.00	20 cells/s	ATM VP	-	-	-	-	-	-
S-30-104	N12104/ATM-VP U9/M1/ATM3/VPI-44	0.06	0.00	100.00	20 cells/s	ATM VP	-	-	-	-	-	-
S-30-104	N12104/ATM-VP U9/M1/ATM3/VPI-43	0.06	0.00	100.00	20 cells/s	ATM VP	-	-	-	-	-	-
S-30-104	N12104/ATM-VP U9/M1/ATM3/VPI-42	0.06	0.00	100.00	20 cells/s	ATM VP	-	-	-	-	-	-
S-30-104	N12104/ATM-VP U9/M1/ATM3/VPI-41	0.06	0.00	100.00	20 cells/s	ATM VP	-	-	-	-	-	-
S-30-104	N12104/ATM-VP U9/M1/ATM3/VPI-40	0.06	58.63	100.00	20 cells/s	ATM VP	-	-	-	-	-	-
S-30-104	N12104/ATM-VP U9/M1/ATM3/VPI-39	0.06	0.00	100.00	20 cells/s	ATM VP	-	-	-	-	-	-

Rows shown: 385 / 1356

Figure 3. PMS Overview dialog from Tellabs 8000 Network Manager Performance Management Package. The dialog includes utilization and capacity values from several different interfaces.