

This material is posted here with permission of the IEEE. Such permission of the IEEE does not in any way imply IEEE endorsement of any of Helsinki University of Technology's products or services. Internal or personal use of this material is permitted. However, permission to reprint/republish this material for advertising or promotional purposes or for creating new collective works for resale or redistribution must be obtained from the IEEE by writing to [pubs-permissions@ieee.org](mailto:pubs-permissions@ieee.org).

By choosing to view this document, you agree to all provisions of the copyright laws protecting it.

PUBLICATION V

©2003 IEEE. Reprinted, with permission, from the publisher

Heine, P., Lehtonen, M., Voltage Sag Distributions Caused by Power System Faults,  
IEEE Transactions on Power Systems, Vol. 18, No. 4, November 2003, pp. 1367-1373.

# Voltage Sag Distributions Caused by Power System Faults

Pirjo Heine, *Member, IEEE*, and Matti Lehtonen

**Abstract**—Voltage sag distributions caused by faults at different voltage levels and experienced by low-voltage customers were established for four different power system areas. The shares of different fault types at each voltage level and the sag propagation throughout the power system were taken into account. The results show that the origin of sags in urban and rural areas tends to be different. These data are needed when, for example, planning measures for sag mitigation in different parts of the power system.

**Index Terms**—Power distribution, power quality, power system modeling, power systems, power transmission, voltage sag.

## I. INTRODUCTION

ACCORDING to IEEE standard 1159-1995, a voltage sag is defined as a decrease to between 0.1 and 0.9 p.u. in root mean square (rms) voltage at the power frequency for durations of 0.5 cycle to 1 min [1]. Voltage sags have always been present in power systems, but only during the past decades have customers become more aware of the inconvenience caused by them.

A power system fault is a typical cause of a voltage sag [2]. Faults occur in transmission (EHV), subtransmission (HV), medium-voltage (MV), and low-voltage (LV) systems, and the sags propagate throughout the power system. The sag distribution experienced by a low-voltage customer includes all these sags of different origin.

It is not essential that all power system areas are modeled and included in voltage sag distribution calculations. This issue is studied in this paper. In addition, voltage sag distributions are calculated for two urban and two rural power system areas. The sag propagation throughout the power system and the probabilities of different fault types at each voltage level are taken into account in the calculations.

## II. VOLTAGE SAGS CAUSED BY FAULTS

Voltage sags can generally be characterized by sag magnitude, duration, and frequency [3]. Network impedances determine the sag magnitude. When considering sags caused by faults, the protection practices specify the sag duration, and the fault frequencies determine the number of voltage sags.

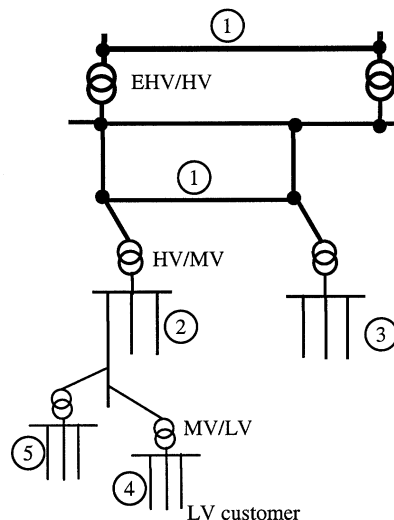

Fig. 1. Origin of fault positions that cause sags experienced by an LV customer.

### A. Sag Distribution

A sag distribution can be determined for each LV customer, categorized in terms of the part of the network in which the fault occurs (Fig. 1):

- 1) transmission and subtransmission systems;
- 2) local MV distribution systems;
- 3) adjacent MV distribution systems;
- 4) local LV distribution systems;
- 5) adjacent LV distribution systems.

The sags experienced by an LV customer can be described by a cumulative distribution function

$$F(u, t)_k = \sum_i^n \sum_{ft} (\lambda_{i,ft} | u_k \leq u, \Delta t_{i,ft} > t) \quad (1)$$

where  $\lambda_{i,ft}$  is the fault frequency of fault type  $ft$  at fault position  $i$ ,  $u_k$  the sagged voltage experienced by an LV customer at node  $k$ , and  $\Delta t_{i,ft}$  the sag duration for the fault place and fault type in question.

Because different fault types cause sags with different characteristics, the fault frequencies of each fault type should be determined. Thus, the fault frequency  $\lambda_i$  at a certain fault position includes the fault frequencies of all fault types: single-phase, two-phase, and three-phase faults, with and without earth connections (2)

$$\lambda_i = \sum_{ft} \lambda_{i,ft} = \sum_{ft} \frac{p_{i,ft}}{100} \lambda_i \quad (2)$$

Manuscript received January 23, 2003. This work was supported in part by TEKES and in part by the Helsinki University of Technology.

The authors are with Helsinki University of Technology, FIN-02015 HUT, Finland (e-mail: pirjo.heine@hut.fi; matti.lehtonen@hut.fi).

Digital Object Identifier 10.1109/TPWRS.2003.818606

and the share of the various fault types  $p_{i,ft}$  will satisfy two properties (3) and (4)

$$0 \leq p_{i,ft} \leq 100\% \quad (3)$$

$$\sum_{ft} p_{i,ft} = 100\%. \quad (4)$$

### B. Sag Magnitude

The calculation of voltages in meshed transmission systems is based on Thevenin's theorem and the network impedance matrix [4]. To calculate the sagged voltage at bus  $i$  caused by a fault at node  $r$ , (5) or (6) can be applied

$$\underline{U}_{sag,i} = \underline{U}_{0,i} - \frac{\underline{z}_{ir}}{\underline{z}_{rr} + \underline{Z}_F} \underline{U}_{0,r} \quad (5)$$

$$\underline{U}_{sag,i} = \underline{U}_{0,i} - \frac{\underline{z}_{ir}}{\underline{z}_{rr}} (\underline{U}_{0,r} - \underline{U}_{sag,r}) \quad (6)$$

where  $\underline{U}_{sag,i}$  and  $\underline{U}_{sag,r}$  are the sagged voltages during the fault at the nodes  $i$  and  $r$ , respectively.  $\underline{U}_{0,i}$  and  $\underline{U}_{0,r}$  are the prefault voltages.  $\underline{z}_{rr}$  is the driving element that corresponds to the diagonal element of the node impedance matrix,  $\underline{z}_{ir}$  the transfer element of the node impedance matrix that corresponds to nodes  $i$  and  $r$ , and  $\underline{Z}_F$  the fault impedance.

For radially operated distribution systems, the calculation can be simplified and a voltage divider model can be used [3]. For example, in the case of a symmetrical three-phase short circuit fault in one radially supplied MV distribution feeder, the sagged voltage on the substation busbar can be calculated using (7)

$$\underline{U}_{sag,i} = \frac{\underline{Z}_L + \underline{Z}_F}{\underline{Z}_S + \underline{Z}_T + \underline{Z}_L + \underline{Z}_F} \underline{U}_{0,i} \quad (7)$$

where  $\underline{Z}_L$  is the impedance between the substation and the fault location,  $\underline{Z}_T$  the impedance of the primary transformer, and  $\underline{Z}_S$  the source impedance of the transmission system.

When considering faults behind a neighboring HV/MV transformer, the PCC (= point of common coupling) is on the HV side of the transformer and (8) should be applied

$$\underline{U}_{sag,i} = \frac{\underline{Z}_{T2} + \underline{Z}_{L2} + \underline{Z}_F}{\underline{Z}_S + \underline{Z}_{T2} + \underline{Z}_{L2} + \underline{Z}_F} \underline{U}_{0,i}. \quad (8)$$

The index 2 refers to the neighboring transformer and feeders connected to this transformer.

### C. Sag Propagation

Although most customers are connected to LV networks, faults occur at all voltage levels. Hence, the sag propagation throughout the entire power system should be modeled. The fault type, earthing practices, and transformer connections determine which voltages are of interest when considering sags at the LV customer location. In this paper, the Finnish power system is used as an example to determine the voltage sag distributions experienced by LV customers, that is:

- 400 and 220 kV transmission systems, looped, neutrals impedance earthed, or solidly earthed;
- 110 kV subtransmission system, looped, neutrals impedance earthed, or unearthed;

TABLE I  
FAULT FREQUENCIES AND SHARES OF DIFFERENT FAULT TYPES FOR  
FINNISH TRANSMISSION SYSTEMS [8]

Voltage (kV)	Fault frequency (faults per year per 100 km)	Shares of different fault types			
		1-phase earth faults	2-phase short circuits	3-phase short circuits	2- or 3-phase earth faults
400	0.28	80%	2%	3%	15%
220	0.72	78%	2%	3%	17%
110	3.5	81%	3%	2%	14%

- 20 kV medium voltage, radially operated, neutral un-earthed, or compensated;
- 0.4 kV low voltage, radially operated, solidly earthed.

Typical transformer connections

- 400/110 kV, 400/220 kV, 220/110 kV: YNyn0d11 (d11, typically 21 kV, is used for compensation);
- 110/20 kV: YNd11;
- 20/0.4 kV: Dyn11.

Y refers to wye connected, d to delta connected, and n to neutral earthed systems. Capitals refer to the primary side and small letters to the secondary side of the transformer.

Sags caused by symmetrical three-phase faults propagate without changes through transformers. In the case of unsymmetrical faults, however, the transformer connections have a strong effect [4]. The phase voltages on the secondary side  $\underline{U}_{sec}$  are derived from the phase voltages on the primary side  $\underline{U}_{pri}$  as follows:

$$\underline{U}_{sec} = \underline{P} \underline{A} \underline{P}^{-1} \underline{U}_{pri} \quad (9)$$

$$\underline{P} = \begin{bmatrix} 1 & 1 & 1 \\ 1 & a^2 & a \\ 1 & a & a^2 \end{bmatrix} \quad (10)$$

$$a = -0.5 + \frac{j\sqrt{3}}{2} \quad (11)$$

$$\underline{A} = \begin{bmatrix} \underline{A}(1,1) & 0 & 0 \\ 0 & 1\angle\alpha & 0 \\ 0 & 0 & 1\angle-\alpha \end{bmatrix}. \quad (12)$$

In (9), matrix  $\underline{P}^{-1}$  transforms the phase voltages to symmetrical components, while matrix  $\underline{P}$  does the opposite. Matrix  $\underline{A}$  determines the transformer type. The element  $\underline{A}(1,1)$  depends on how the zero sequence component propagates through the transformer. If the zero sequence current cannot penetrate both the windings, then  $\underline{A}(1,1)$  is set to zero. In a YNyn transformer with both neutrals earthed,  $\underline{A}(1,1) = 1$ . Angle  $\alpha$  is determined by the change in the positive sequence voltage.

### D. EHV and HV Faults Experienced by an LV Customer

1) *Fault Frequencies of Transmission Systems:* In transmission systems, fault frequencies are typically small and the share of single-phase to earth faults is about 80% [5]–[8]. In Table I, the long-term fault frequencies and shares of different fault types for Finnish transmission systems are presented [8].

2) *Sag Propagation From Transmission to LV Systems:* When an earth fault occurs in a transmission system, one phase voltage is sagged, the neutral point voltage will rise,

and the voltages of the sound phases will increase. In Finland, 400 and 220 kV systems are earthed either solidly or through an inductance. The earth fault factor is  $c_k < 1.39$ , which means that during earth faults the maximum phase to ground voltage in sound phases is 1.39 times the rated phase to ground voltage [8]. The subtransmission system is either earthed via an impedance or left ungrounded so that in 110 kV systems the earth fault factor is typically  $c_k < 1.7$  [8]. In a resistance or high-impedance grounded system, the zero sequence source impedance differs significantly from the positive and negative sequence voltages. When a single-phase earth fault occurs in phase R (assuming  $Z_{S1} = Z_{S2}$  and  $Z_{F1} = Z_{F2}$ ), the phase voltages (p.u.) are [3]

$$\begin{aligned} \underline{U}_R &= 1 - \frac{Z_{S0} + 2Z_{S1}}{(2Z_{F1} + Z_{F0}) + (2Z_{S1} + Z_{S0})} \\ \underline{U}_S &= \underline{a}^2 - \frac{Z_{S0} - Z_{S1}}{(2Z_{F1} + Z_{F0}) + (2Z_{S1} + Z_{S0})} \\ \underline{U}_T &= \underline{a} - \frac{Z_{S0} - Z_{S1}}{(2Z_{F1} + Z_{F0}) + (2Z_{S1} + Z_{S0})} \end{aligned} \quad (13)$$

where index  $S$  refers to the source impedance and  $F$  to the impedance from the PCC to the fault. Further, index 1 refers to the positive, 2 to the negative, and 0 to the zero sequence impedances.

When considering a single-phase earth fault in a 110 kV system in terms of the voltages seen by an LV customer, the zero sequence voltages do not propagate through the YNd and Dyn transformers from the 110 kV to the 0.4 kV network. Hence, when applying (9) to the LV the side, (13) reduces to the form

$$\begin{aligned} \underline{U}'_R &= 1 - \frac{2Z_{S1}}{(2Z_{F1} + Z_{F0}) + (2Z_{S1} + Z_{S0})} \\ \underline{U}'_S &= \underline{a}^2 - \frac{-Z_{S1}}{(2Z_{F1} + Z_{F0}) + (2Z_{S1} + Z_{S0})} \\ \underline{U}'_T &= \underline{a} - \frac{-Z_{S1}}{(2Z_{F1} + Z_{F0}) + (2Z_{S1} + Z_{S0})}. \end{aligned} \quad (14)$$

When  $Z_{S0} \gg Z_{S1}$ , the sagged voltage remains high, even in the case of a terminal fault. Thus, the lowest phase voltage at an LV customer location caused by earth faults in a 110 kV system is quite high (in Finland, typically  $U_{\text{sag}} > 80\%$ ). Equation (14) is also valid for earth faults in the EHV system. Because the zero sequence impedances in the EHV system are smaller than in the HV system, an LV customer experiences lower sagged voltages during earth faults in the EHV system than during earth faults in the HV system.

Further, because the transformer connections in the HV/MV transformer are YNd11 and in the MV/LV transformer are Dyn11, sagged phase voltages caused by three- and two-phase short circuits in the HV system have a similar appearance on the LV side. In the case of a three-phase short circuit of  $R_F = 0 \Omega$  in an EHV or HV system, the sagged voltages are 0% in all phases at an LV customer location. In the case of a two-phase short circuit of  $R_F = 0 \Omega$ , the sagged voltages of the faulted phases are 50% of nominal at an LV location while the phase voltage of the sound phase remains unchanged. In two-phase to ground faults in transmission systems, the minimum voltages at the LV location are slightly lower than in two-phase short circuits [3].

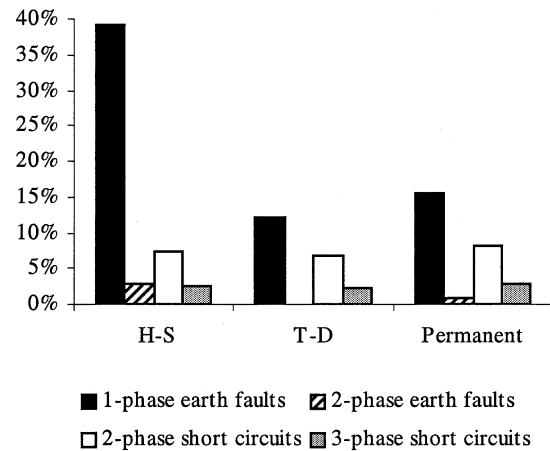

Fig. 2. Shares of different faults for one power distribution company: faults cleared by high-speed (H-S) reclosers, time-delayed (T-D) reclosers, and permanent faults.

### E. MV Faults Experienced by an LV Customer

1) *Fault Frequency of MV Systems:* While transmission networks typically consist of overhead lines, MV networks consist of underground cables in urban areas and overhead lines in rural areas. The fault frequency of an MV overhead line network can be remarkably high. This is primarily due to construction and reclosing practices. Traditionally, the MV faults reported by power distribution companies only include data from permanent faults. A typical frequency of permanent MV faults is four faults per year per 100 km [9]. However, these data are not adequate for voltage sag calculations, where the faults cleared by automatic circuit reclosers and the shares of different fault types should also be known.

A detailed study of MV fault frequencies based on the fault statistics of a Finnish power distribution company has been performed. The material includes 720 faults over a period of 2.5 years. The company has an MV network of bare conductor overhead lines (50%), covered conductor lines (15%), and underground cables (35%) with an ungrounded neutral. Reclosers are in use, but not in purely underground cable feeders. The main results of the study were (Fig. 2)

- 1) Fifty-two percent of MV faults were cleared by high-speed (H-S) reclosers, 21% by time-delayed (T-D) reclosers, and 27% remained as permanent faults.
- 2) The shares between earth faults and short circuits depend on the network type. In cable feeders, the respective shares were 80% for earth faults and 20% for short circuits. In feeders where reclosers are in use, the shares of fault types depend on the fault clearing type. In faults cleared by H-S reclosers, the share of earth faults was 75%, and for T-D reclosers and permanent faults was 50%.
- 3) The probability of two-phase short circuits was four times the probability of three-phase short circuits.

In comparison with the national statistics, values like 76% for H-S, 17% for T-D, and 7% for permanent faults have been reported [9]. Otherwise, the results are quite similar to the findings in [9] and [10].

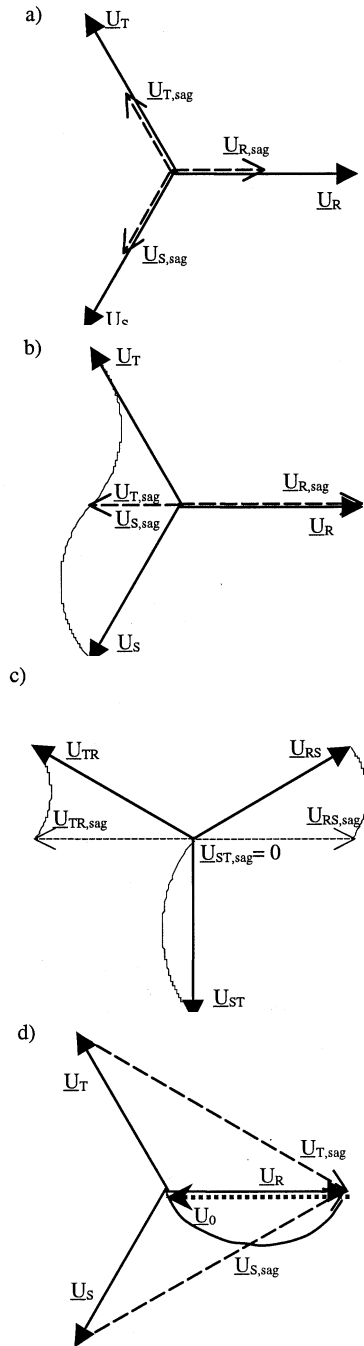

Fig. 3. Sagged p.u. voltages of (a) a three-phase short circuit, (b) a two-phase short circuit (phase voltages), (c) a two-phase short circuit (phase-to-phase voltages), and (d) an earth fault (phase voltages) in an MV network with an unearthened neutral.

2) *Sag Propagation From MV to LV Systems:* The typical connection of an MV/LV transformer is Dyn11. This means that in (12) the element  $\underline{A}(1, 1)$  is zero and the angle  $\alpha = 330^\circ$ . Further, the phase-to-phase voltage on the MV voltage side is seen as a phase voltage on the LV side.

In the case of a symmetrical three-phase fault on the MV side, all three phase-to-phase and phase voltages will collapse to the same degree and propagate without changes to the LV side. In the example presented in Fig. 3(a), a three-phase short circuit causes a remaining voltage of 50%.

In the case of a two-phase short circuit of fault resistance  $R_F = 0 \Omega$ , two of the phase voltages sag to a voltage of  $U_{S,sag} = U_{T,sag} = 50\%$  while the other remains unchanged,  $U_{R,sag} = U_R$  [Fig. 3(b)]. Further, only one phase-to-phase voltage collapses to zero while the other two phase-to-phase voltages decrease to 87% of the nominal voltage [Fig. 3(c)]. Thus, during two-phase short circuits on the MV side, only one phase voltage on the LV side is substantially disturbed.

When an earth fault occurs in a high impedance earthed medium voltage distribution network, the neutral point voltage rises and the phase voltages of the sound phases increase. If the fault resistance is  $0 \Omega$ , the phase voltages of the sound phases reach the value of the phase-to-phase voltages. Because of the shift in the neutral point, there is no change in the phase-to-phase voltages on the MV side. Further, there will be no collapsed phase voltages on the LV side [Fig. 3(d)].

### III. MODELED POWER SYSTEM AREAS

#### A. Sags Caused by Faults in EHV and HV Systems

Because of the meshed structure of transmission systems, the sagged area caused by a transmission fault is typically large. The affected line length may be hundreds of kilometers. The sag distribution caused by transmission faults is highly dependent on the location of the supply point in the transmission system. In addition, if local generation exists, this will also have a strong effect on the sag distribution [11], [12]. To evaluate the sagged area, the network impedance matrix of the meshed network should be calculated (5), (6).

#### B. Sags Caused by Faults in MV Networks

Most of the faults affecting LV customers occur in MV networks. An LV customer experiences sags caused by faults in the neighboring MV feeders and also via the HV systems, from faults in the MV networks located behind the neighboring substations.

1) *Faults in Neighboring MV Feeders:* MV networks are operated radially. The most serious sags caused by MV faults are those in the neighboring feeders of the sag sensitive customer. In faults near an HV/MV substation, the voltage collapses to nearly zero (7). The further away from the substation the fault occurs, the higher the remaining voltage on the substation busbar will be. A strong subtransmission system and a large transformer contribute to a higher remaining voltage (Fig. 4). These properties have approximately the same impact on the sagged voltage.

2) *Faults Behind Neighboring HV/MV Transformers:* In the case of a fault behind a neighboring HV/MV transformer, the sagged voltage will not collapse to a high degree because the transformer impedance is now on the load side of the PCC (8).

The further away the neighboring substation is located, the less severe the sag will be. However, the effect of the HV line length is small (Fig. 5). The sagged voltage is lowest in the case of a weak transmission system and a large neighboring HV/MV transformer (Fig. 6). The short circuit level of the transmission system is the most critical factor in this analysis. In typical

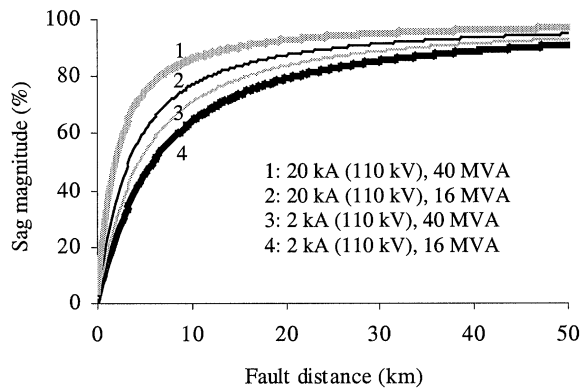

Fig. 4. Effect of the short circuit level of the subtransmission system and the HV/MV transformer rating on voltage sag magnitude, when a three-phase fault occurs in the neighboring MV feeder,  $\bar{z}_L = 0.4 + j0.4 \Omega/\text{km}$ ,  $Z_F = 0 \Omega$ .

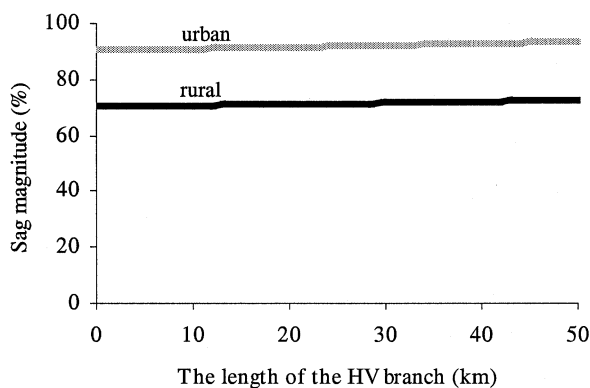

Fig. 5. Sag magnitude as a function of the HV line length for typical rural [2-kA (110-kV), 16-MVA transformer] and urban [20-kA (110-kV), 40-MVA transformer] systems,  $\bar{z}_{\text{HVline}} = 0.1 + j0.4 \Omega/\text{km}$  (110 kV),  $Z_F = 0 \Omega$ .

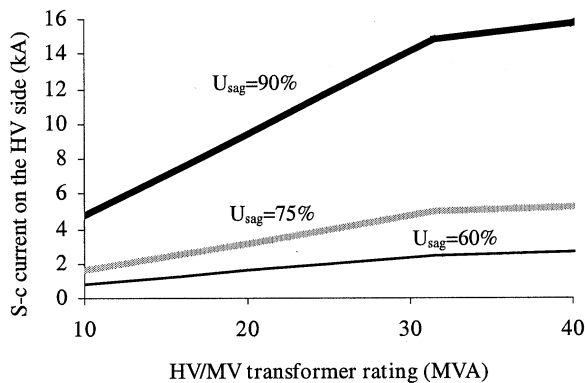

Fig. 6. Sagged voltage caused by a three-phase short circuit behind a neighboring HV/MV transformer  $Z_F = 0 \Omega$ .

urban areas that have strong transmission systems, the sag impact of networks behind neighboring substations may even be neglected.

### C. Sags Caused by Faults in LV Networks

Typically, sags caused by LV faults are not taken into account in a sag distribution [3] because:

- LV faults are rare [9];
- one distribution transformer supplies only a small number of customers and, thus, these sags have only a minor and very local impact on the overall sag distribution;

- fuses limit the fault current and thus also the voltage drop.

As for sags caused by MV faults, the most serious sags caused by LV faults are those in the neighboring feeders near the MV/LV transformer. These sags are rare, however. Further, when considering sags caused by LV faults behind neighboring MV/LV transformers, the impedance between the MV busbar (PCC) and the fault location consists of the MV/LV transformer and LV lines. The sagged voltages remain high because the MV/LV transformers have a rather large impedance and the impedance of the LV line referred to the MV side also represents a high value. For example, in Finland one typical MV/LV transformer rating is 315 kVA,  $z_k = 5.0\%$ . This represents a transformer impedance of  $63.5 \Omega$  on the MV side. In addition, when the LV line impedance is referred to the MV side, the LV line impedance is multiplied by a factor of  $(20/0.4)^2 = 2500$ . In a strong city network [40 MVA 110/20 kV transformer and  $I_k = 20 \text{ kA}$  (110 kV)], this means a sagged voltage of  $U_{\text{sag}} > 98\%$  on the MV busbar and a corresponding value of  $U_{\text{sag}} > 94\%$  in a weak rural area (16 MVA, 2 kA). Thus, in practice, sags caused by faults behind MV/LV power transformers can be neglected in sag analysis.

## IV. STUDY CASES: SAGS IN RURAL AND URBAN SYSTEMS

As study cases, sag distributions are calculated for four different LV points in Finland: 1) Urban1, east; 2) Rural2, east; 3) Urban3, south; 4) Rural4, south. In this study, the sag distribution includes sags caused by faults in 110 kV and 20 kV systems. The 220 kV and 400 kV transmission networks are neglected because of the small quantity of 220 kV line length and the low fault frequency in the 400 kV system. It was shown earlier that the sags caused by LV faults only have a very marginal effect on sag distribution and are not taken into account in this paper. Different fault types are taken into account according to (1) and (2) [13].

Two models of the 110 kV systems have been determined, one for the eastern and the other for the southern area [14]. The eastern area of  $200 \times 200 \text{ km}$  has 1600 km of 110 kV transmission lines. The model has two supply points to the 400 kV network (the distance between the 400 kV nodes is 150 km). The study points 1 and 2 are situated at a distance of about 150 km from the 400 kV supply points. Study point 1 is situated at a point where four loops branch off, and point 2 is located at the far end of a 30 km branch of a single loop.

The modeled southern part includes the 110 kV networks of two cities having 400 km of 110 kV lines. In southern Finland, the number of 400/110 kV substations is higher and, thus, the distance between substations is substantially smaller (30–50 km) than in the eastern area. In addition, the cities in southern Finland have a considerable amount of local generation. Study point 3 is situated in a looped city area at a distance of 15 km and 25 km from a 400 kV node. Point 4 is located at a distance of 10 km and 30 km between two 400 kV nodes.

The share of earth faults is 80% (Table I). In this paper, it is assumed that the share of three-phase short circuits is 3%, and two-phase and two-phase-to-ground faults 17%. As was shown earlier, sags caused by earth faults in an HV system are barely discernible at an LV customer location and can be neglected in

TABLE II  
INPUT MV DATA FOR THE CASE STUDIES

	Urban1 east	Rural2 east	Urban3 south	Rural4 south
110 kV s-c current (kA)	7.5	2.5	32.3	15.2
HV/MV transformer rating (MVA)	16	16	40	16
Number of feeders	9	5	12	6
Total feeder length (km)	8.9	65.9	11.1	27.8
Main feeder length (km)	5.2	26.7	9.0	19.7
Laterals per feeder	5.0	7.0	1.1	2.0
Feeder resistance ( $\Omega$ /km)	0.50	0.83	0.18	0.40
Feeder reactance ( $\Omega$ /km)	0.34	0.37	0.12	0.38
Fault frequency (faults per year per km) (permanent faults only)	0.034	0.062	0.045	0.083

TABLE III  
EXPERIENCED SAGS PER YEAR BY AN LV CUSTOMER

	$U_{\text{sag}} < 50\%$		$U_{\text{sag}} < 90\%$	
	20 kV	110 kV	20 kV	110 kV
Urban1, east	3.7	1.1	5.0	6.8
Rural2, east	7.7	1.0	36.9	5.1
Urban3, south	0.6	0.7	1.6	1.6
Rural4, south	4.7	0.4	29.5	1.7

this analysis. The effect of two-phase short circuits is taken into account by a factor of 2/3. This assumption slightly exaggerates the frequency of the most serious sags, however.

Sag distributions caused by MV faults are calculated using MV data in Table II [15]. The fault frequency in Table II has been determined from data for permanent faults. In the calculations, it is assumed that the fault frequency is constant along the entire feeder length. It is assumed that in urban areas there are two transformers at a substation while substations in rural areas have only one.

In point Urban3, south, the reclosers are not in use and the share of short circuits is 20%. In points 1, 2, and 4, it is assumed that 7% of the faults are permanent (of which 50% are short circuits), 17% are cleared by time-delayed (30% short circuits), and 76% by high-speed reclosers (30% short circuits). Further, it is assumed that a third of the short circuits are three-phase short circuits.

Faults were applied to all of the lines in the modeled areas and the voltage profiles for the LV study points were computed by applying (1). Different fault types were taken into account by (2) and the sag propagation by applying (9). Sag frequencies caused by HV faults, by MV faults in the neighboring feeders, and by faults behind neighboring HV/MV substations are presented in Table III and Fig. 7.

Results show that sag distributions are highly dependent on the power system characteristics. In addition, the following characteristics also hold.

- The LV customer Urban1, east, experiences the highest number of sags caused by transmission faults. In the eastern area, the study points 1 and 2 are situated far away from the 400 kV supply points and the amount of local generation in the area is small. These characteristics are

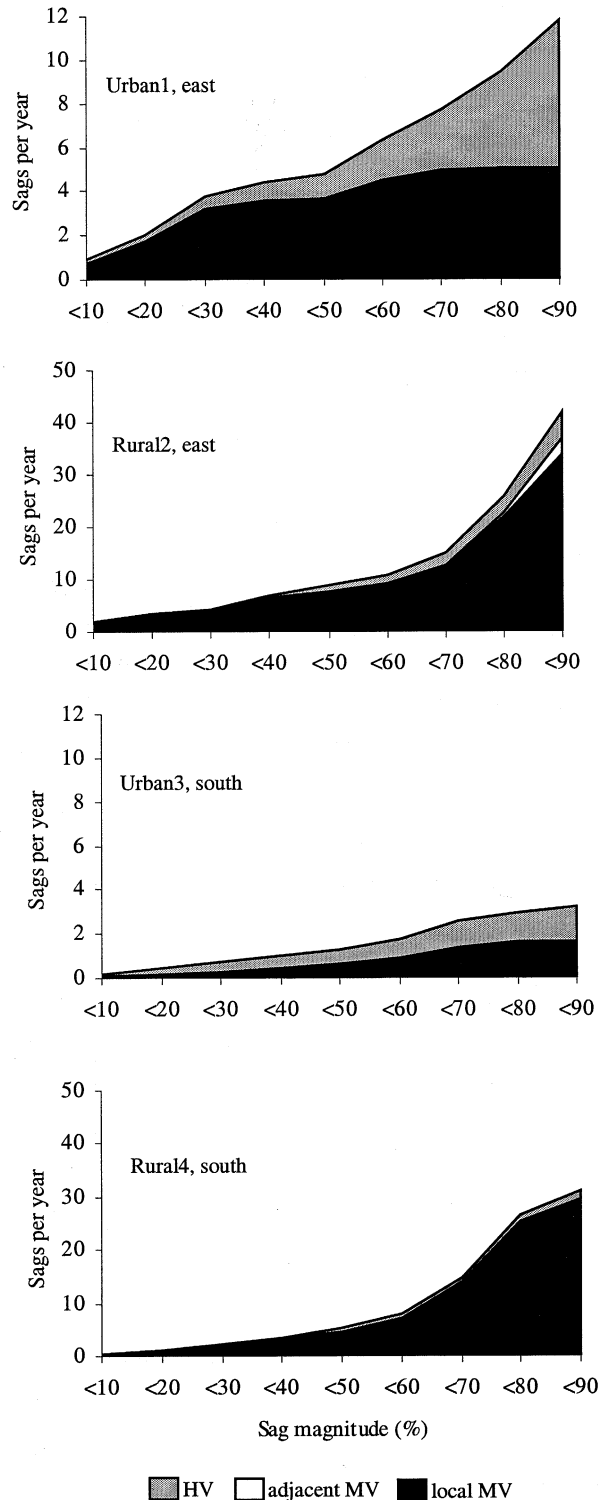

Fig. 7. Cumulative number of sags experienced by an LV customer caused by faults in HV, adjacent MV and local MV systems.

- due to the longer critical line lengths of 110 kV networks in the eastern area.
- In southern urban city areas, sags caused by MV faults are rare, and transmission faults are the most prominent cause of sags.



- The annual number of sags is clearly higher in rural areas than in urban areas.
- In rural areas having long overhead line networks, the share of shallow, less serious sags is noticeably higher than the share of the most serious sags.
- It is only in the eastern rural area, where the transmission network is particularly weak, that faults behind a neighboring HV/MV transformer cause sags that affect the sag distribution. In the study cases, only sags having a higher remaining voltage than 75% were included in this sag category. In all of the other study cases, the faults behind neighboring HV/MV transformers could be neglected.

In principle, faults on all voltage levels contribute to the sag distribution experienced by an LV customer but, because of network characteristics, the sags caused by faults in some parts of the power system are shallow or even negligible. Thus, it is not essential for all power system areas to be modeled and included in voltage sag distribution calculations.

The results shown have similarities to the findings in [16]. Knowledge of the network characteristics enables the sag distribution to be assessed by calculations, although long measurement periods would offer the most precise case- and site-sensitive data.

## V. CONCLUSION

Sag distributions are highly dependent on network characteristics. The sag distribution experienced by an LV customer includes sags caused by faults at all voltage levels. Because of the construction of the meshed transmission system, sags caused by transmission faults propagate long distances, and affect urban and rural areas as well.

In urban areas, transmission faults are an important cause of sags, although the low fault frequency of underground cable MV networks and short MV feeder lengths contribute to low sag frequencies. In addition, in urban areas, the strong transmission system prohibits sags caused by faults behind the neighboring substations from being experienced in other MV networks.

In contrast, in rural systems having typically long MV overhead line feeders and reclosers in use, MV faults represent the main cause of sags. The sag distribution mainly consists of sags caused by faults in the neighboring MV feeders. In the case of a weak transmission system, the faults behind the neighboring substation may be of significance. The sag frequency of the shallowest sags can be unpredictably high.

The kind of calculation and data concerning voltage sag characteristics and the origin of the majority of voltage sags presented in this paper is valuable when planning voltage sag mitigation measures in different parts of the power system. The results given were calculated using data from Finnish networks and may, for example, not be entirely applicable to networks with different neutral earthing configurations.

## REFERENCES

- [1] *IEEE Recommended Practice for Monitoring Electric Power Quality*, IEEE Std. 1159-1995, June 1995.
- [2] *IEEE Guide for Service to Equipment Sensitive to Momentary Voltage Disturbances*, IEEE Std 1250-1995, Mar. 1995.
- [3] M. H. J. Bollen, "Understanding power quality problems," in *Voltage Sags and Interruptions*. Piscataway, NJ: IEEE Press, 1999.
- [4] I. J. Nagrath and D. P. Kothari, *Modern Power System Analysis*, 2nd ed. New Delhi, India: TATA McGraw-Hill, 1989.
- [5] D. Sikes, "Comparison between power quality monitoring results and predicted stochastic assessment of voltage sags—"Real" reliability for the customer," *IEEE Trans. Ind. Applicat.*, vol. 36, pp. 677–682, Mar./Apr. 2000.
- [6] J. A. Martinez and J. Martin-Arnedo, "Voltage sag analysis using an electromagnetic transients program," in *Proc. IEEE Power Eng. Soc. Winter Meeting*, vol. 2, 2002, pp. 1135–1140.
- [7] Nordel Driftstörningsstatistik Fault Statistics 1999, 49 p.
- [8] J. Elovaara and Y. Laiho, *Sähkölaitostekniikan perusteet* (in Finnish), 487 p., Otatieto Oy, Finland, vol. 499, 1988.
- [9] Sähköenergialiitto ry, *Keskeytystilasto 1998* (Interruption Statistics 1998) (in Finnish), 18 p., Helsinki, Finland, 1999.
- [10] S. Hänninen and M. Lehtonen, "Characteristics of earth faults in electrical distribution networks with high impedance earthing," *Electric Power Syst. Res.*, vol. 44, pp. 155–161, 1998.
- [11] J. V. Milanovic, R. Gnativ, and K. W. M. Chow, "The influence of loading conditions and network topology on voltage sags," in *Proc. Int. Conf. Harmon. Quality of Power*, Orlando, FL, Oct. 1–4, 2000, pp. 757–762.
- [12] J. V. Milanovic and R. Gnativ, "Characteristics of voltage sags in radial networks with dynamic loads and embedded generators," presented at the *Proc. IEEE Porto Power Tech*, Porto, Portugal, Sept. 10–13, 2001.
- [13] P. Heine, P. Pohjanheimo, M. Lehtonen, and E. Lakervi, "A method for estimating the frequency and cost of voltage sags," *IEEE Trans. Power Syst.*, vol. 17, pp. 290–296, May 2002.
- [14] P. Heine and M. Lehtonen, "Influence of subtransmission system characteristics on voltage sags," presented at the *Proc. Int. Conf. Harmon. Quality of Power*, Rio de Janeiro, Brazil, Oct. 6–9, 2002.
- [15] M. Lehtonen, S. Kärkkäinen, and J. Partanen, *Kokonaisvaltainen sähkölaitosautomaatiokonsepti Suomessa* (Future distribution automation system for Finnish utilities), (in Finnish), in *Valtion teknillinen tutkimuskeskus, VTT Tiedotteita—Meddelanden—Research Notes 1621*, Espoo, 1995.
- [16] M. H. J. Bollen, "Fast assessment methods for voltage sags in distribution systems," in *Proc. Ind. Applicat. Conf.*, Oct. 8–12, 1995, pp. 2282–2289.

**Pirjo Heine** (M'99) was born in 1963. She received the Master of Science degree from the Tampere University of Technology, Tampere, Finland, in 1987.

Currently, she is a Researcher with the Power Systems Laboratory of the Helsinki University of Technology, Helsinki, Finland. Her main interests are in power quality issues of distribution networks.

**Matti Lehtonen** was born in 1959. He received the Master's and Licentiate degrees from the Helsinki University of Technology, Helsinki, Finland, in 1984 and 1989, respectively, and the Doctor of Technology degree from the Tampere University of Technology, Tampere, Finland, in 1992.

Currently, he is with VTT Energy, Espoo, Finland, where he has been since 1987. He has also been with the Helsinki University of Technology since 1999. His research interests include earth fault problems, harmonic-related issues, and applications of information technology in distribution automation and energy management.