

Aalto University School of Engineering
Department of Energy Technology
Individual Assignment in Environment Friendly Energy Processes

Biomass Gasification

Mikko Kouhia*

11th April 2011

AALTO UNIVERSITY SCHOOL OF ENGINEERING http://www.aalto.fi/	ABSTRACT	
Author: Mikko Kouhia		
Title: Biomass Gasification		
School: School of Engineering		
Department: Department of Energy Technology		
Professorship: Energy Engineering and Environmental protection	Code: Ene-47	
Supervisor: Carl-Johan Fågelholm		
Instructor: Loay Saeed		
<p>Abstract:</p> <p>There is great interest in the utilization of biomass in high efficiency power generation and in the production of high quality synthetic fuels and chemicals. Gasification, among biochemical conversion, is one way to achieve this goal.</p> <p>In this report the operational principle of gasification is reviewed, an analysis of different biomasses is presented and the main gasifier types are examined. The product gas composition, cleaning and utilization are examined and the commercial status of gasification is studied.</p> <p>There are many ways to gasify biomass, but the most common way in medium-to-large scale is to use atmospheric circulating fluidized bed gasifiers; downdraught fixed bed gasifiers are used in a smaller scale</p> <p>Gasification has not yet achieved extensive usage, but it is likely to be utilized increasingly in the future as an environmentally friendly way to produce power, fuels and chemicals.</p>		
Date: 11.4.2011	Language: English	Number of pages: 38
Keywords: Biomass, Gasification, Synthesis gas		

Contents

1	Introduction	1
2	Thermodynamics of Gasification	3
3	Biomasses and Their Characteristics	5
4	Gasification Processes	11
4.1	Fixed Bed Gasifiers	12
4.1.1	Updraught Fixed Bed Gasifier	12
4.1.2	Downdraught Fixed Bed Gasifier	14
4.1.3	Cross-Draught Fixed Bed Gasifier	15
4.1.4	Open-Core Fixed Bed Gasifier	15
4.2	Fluidized Bed Gasifiers	17
4.2.1	Bubbling Fluidized Bed Gasifier	18
4.2.2	Circulating Fluidized Bed Gasifier	18
4.3	Entrained Flow Gasifiers	19
5	The Product Gas	23
5.1	Product Gas Composition	23
5.2	Product Gas Cleaning	25
5.3	Utilization of the Product Gas	27
6	Commercial Status of Biomass Gasification	29
6.1	Commercially Available Gasification Processes	29
6.2	Case Studies	30
6.2.1	Kymijärvi Power Plant	30
6.2.2	Güssing Power Plant	31
7	Conclusions	33
	Bibliography	35

Nomenclature

Abbreviations

BFB	Bubbling fluidized bed
CFB	Circulating fluidized bed
CHP	Combined heat and power
DME	Dimethyl ether
ESP	Electrostatic precipitator
FICFB	Fast internal circulating fluidized bed
IGCC	Integrated gasification combined cycle
ppb	Parts per billion, 10^{-9}
RDF	Refuse derived fuel
SNG	Substitute natural gas
SOFC	Solid oxide fuel cell
Syngas	Synthesis gas

Subscripts

th	Thermal
----	---------

Chemical species

Al_2O_3	Aluminium oxide
C	Carbon
CH_4	Methane
CO	Carbon monoxide
CO_2	Carbon dioxide
COS	Carbonyl sulphide
CaO	Calcium oxide
Cl	Chlorine

Fe_2O_3	Ferric oxide
H	Hydrogen
H_2	Hydrogen, molecular
H_2O	Water
K	Potassium
KOH	Potassium hydroxide
K_2O	Potassium oxide
K_2CO_3	Potassium carbonate
MgO	Magnesium oxide
N	Nitrogen
N_2	Nitrogen, molecular
Na	Sodium
Na_2O	Sodium oxide
Ni	Nickel
O	Oxygen
O_2	Oxygen, molecular
P_2O_5	Phosphorus pentoxide
S	Sulphur
SO_3	Sulphur trioxide
SiO_2	Silicon dioxide
TiO_2	Titanium dioxide

Concepts

Carbon conversion

The mass ratio of carbon in the product gas to the carbon in the feedstock.

Cold gas efficiency

The ratio of the product gas heating value to the feedstock heating value. The sensible heat of the product gas is not taken into account, as it is when defining the hot gas efficiency.

Fischer–Tropsch process

A synthesis process in which carbon monoxide and hydrogen are converted to liquid hydrocarbons.

Integrated gasification combined cycle

A given fuel is gasified and the product gas is cleaned into a very pure state. The gas is then combusted in the gas turbine of a combined cycle power plant.

Product gas

The gas mixture that is produced in gasification. Product gas consists of carbon monoxide, carbon dioxide, hydrogen, methane, possibly nitrogen and lesser amount of other species, such as ammonia and hydrogen cyanide.

Synthesis gas

A mixture of carbon monoxide and hydrogen. Synthesis gas is an important intermediary in fuel and chemical production.

1 Introduction

Gasification is generally regarded as a process that is used to convert carbonaceous matter into a gas that has a useful heating value [1, p. 1]. In most cases this stands for understoichiometric combustion with air or oxygen but the definition also includes decomposition of carbonaceous matter in an oxygen-free environment. Such processes could be for example pyrolysis or steam-only gasification. In this report the focus will be on partial combustion, but the involvement of steam in gasification processes will also be discussed.

The first partial combustion gasifiers appear in the middle of the 19th century; the produced gas, *town gas*, was used in illumination and later in heating. The feedstock was mainly coke or coal. The gasifiers spread vastly and were developed during the era, but in the 1920's the usage of oil started to take over the industry [2].

A compact downdraught gasifier was developed between 1920's and 1940's [2], which gained very much automotive use during the Second World War. In war time Germany the oil supplies were mostly allocated to military use, and the fuel shortage was compensated by producing liquid fuels generated from synthesis gas via *Fischer-Tropsch process*. The synthesis gas was produced from lignite. [3]

Another country that has had special interest in gasification technology is South Africa. In 1950, local politicians were deeply concerned of the fact that South Africa did not have national oil reserves, thus being economically vulnerable to foreign influences. The South African coal, oil and gas corporation (*Suid Afrikaanse Steenkool en Olie*, Sasol) was founded to produce liquid fuels from the country's coal resources. This became of use not later than the 1970's, when South Africa faced an international oil embargo due to its apartheid policy. [4]

The energy crises in the 1970's led to new interest in gasification, especially in the field of substitute natural gas (SNG) production from coal [1, p. 5]. In the beginning of the 1980's, first circulating fluidized bed gasifiers were applied by Lurgi and Ahlström [5], but general interest in gasification technology faded a bit due to lowered petroleum prices. In the 1990's gasification regained its status, particularly in the form of small-scale biomass gasification plants. Canada, Finland, Sweden and the USA are the countries that have initially been involved in gasification research and development, accompanied lately by Austria, Denmark, Germany, Italy, the Netherlands, Switzerland and the UK [5].

Very much research has been done lately on gasification, for example in the fields of product gas cleaning, integrated gasification combined cycles (IGCC) and producing so-called biofuels from gasified biomass.

Possible applications of gasification technology include heat and electricity production via IGCCs or via burning the product gas in a conventional boiler, and chemical and fuel production from synthesis gas. For biomass, the IGCC as well as fuel and chemical production are rather much in research state, but they are commercially applied in coal gasification [5]. Gasification technology is also used in waste-to-energy applications. Even though gasification is more complex process than incineration, the product gas is considered easier to clean than the flue gases of a combustion system and also the thermal efficiency will be significantly higher [6].

It is to be remembered that a gasification system consists not only of the gasification reactor itself, but also includes feedstock handling and pretreatment and product gas cleaning equipment. However, biomass preparation processes such as loading, storing, crushing and drying are not included in the scope of this report.

In this report the theoretical side of gasification is first discussed, after which some biomasses are analyzed. The discussed feedstocks are most commonly available materials of biological origin that are have been regarded as suitable for gasification purposes. After the biomass considerations, the gasification process itself is examined in different reactors and in various operating conditions; then the product gas and its components and utilization are inspected. Lastly the current commercial status of gasification is investigated.

2 Thermodynamics of Gasification

In this chapter the main operational principles of gasifying are analyzed. Different stages of gasification process are reviewed and the main reactions that are involved are presented.

After a feedstock enters the gasifier, it undergoes the following stages:

Drying. The moisture that is contained in the particles escapes.

Pyrolysis or devolatilization. After the feedstock is dry, volatile components evaporate. Such components are mainly light hydrocarbons, and can add up to more than 80 % of the total weight of dry biomass.

Oxidation. After the volatiles have left the particles, only the char is left behind. This is then either oxidized or otherwise reacted with the surrounding compounds, depending whether or not there is free oxygen in the particular area of the reactor; some of the volatiles may also be oxidized. Char combustion is normally the rate limiting step for gasification processes [1, p. 36].

Reduction. In substoichiometric conditions some of the CO_2 produced is reduced back to CO . Other reducing reactions happen as well.

The rates and the sequences of these stages vary according to the reactor type: for example in a downdraught gasifier the devolatilization happens in fresh gasification agent before the oxidation zone, thus the volatiles are mainly oxidized at a later stage. Vice versa, in an updraught gasifier the volatiles are released into gas that comes from the reduction zone, so the volatile compounds end up quite unchanged in the product gas.

The temperature level of gasifiers is normally in the range of 800–1800 °C [1, p. 11]; it is a variable parameter that is adjusted on the basis of the biomass quality and reactor type. In an entrained flow gasifier the temperature is very high as the gasification is typically conducted with pure oxygen and the ash is wanted to remain in liquid phase; correspondingly, when the ash is very aggressive and it is wanted to be kept from melting, the temperature level has to be kept rather low. More of these will be discussed in Chapters 3 and 4.

In following paragraphs the main reactions that happen in the gasifier are listed. The combustion reactions are [1, p. 12]:

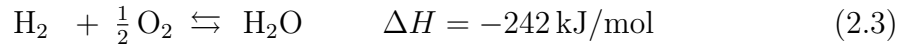
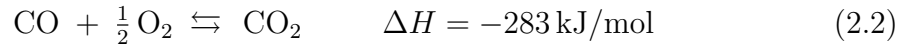
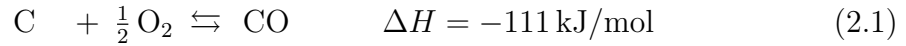

These are all exothermic reactions that are essentially completed in the circumstances of the combustion zone.

The reactions that happen under substoichiometric conditions are the Boudouard reaction (2.4), the water gas reaction (2.5) and the methanation reaction (2.6) [1, p. 12]:



As in most cases the *carbon conversion* is essentially complete, the reactions (2.4)–(2.6) can be reduced to the CO shift reaction (2.7) and to the steam methane reforming reaction (2.8) [1, p. 13]:

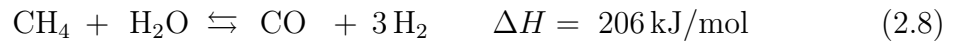

As can be seen from the reactions presented, there are many ways in which elemental carbon can be converted to carbon monoxide. Generally, the gasification reaction is dominated and can be represented by reactions (2.1) and (2.5), but the others are equally important in modeling and understanding the process [1, p. 13].

All in all, this leads us to the situation that the biomass that is led into the gasifier comes out as product gas with useable heating value. Product gas and its components are further discussed in Chapter 5; examples of product gas composition are given in Table 5.1 on page 24.

3 Biomasses and Their Characteristics

This chapter is a brief summary of the most common biomasses that are generally used in gasification processes. Some problems related to the individual properties will be brought out, and the respective solutions are discussed.

Biomasses that fall into focus of this report can be roughly divided into two categories: products originated from forestry and agriculture. The former consists of woody biomass such as woodchips, bark and sawdust and the latter of residual matter such as husks, straw and bagasse and also cultivated energy plants. Black liquor is also considered here as biomass, but such agricultural byproducts as poultry litter are not investigated in this report.

All solid matters share properties that contribute to its usefulness as fuel or feedstock, some of which are heating value, bulk density, hardness, reactivity and composition including moisture content, volatile matter content, ash content and elemental composition. These properties are discussed in the following paragraphs.

Heating value is a very important factor for a matter to be used as fuel, or in this case as feedstock for producing gaseous fuels. If the heating value is very low, the chemical energy transported into the product gas will be negligible, and the whole process would be meaningless. The factors that influence the heating value the most are the carbon, hydrogen and moisture contents of the matter. This is illustrated in Figure 3.1, where the heating value of certain fuel groups are plotted versus the volatile matter content of the fuel.

Bulk density determines the energy density for a given substance, together with the heating value. Biomasses that have low bulk density are generally more expensive to handle, transport and store per energy unit obtained, thus being less economical than those of greater density. Low density also potentially contributes to channeling and bridging in a fixed bed gasifier [2], which are very undesired. They lead to decreased gasifier throughput and unplanned operation of the gasifier.

Hardness of the biomass also affects the operation of the gasifier and the feed system. Should such a fuel be used in a fixed bed gasifier that is presented into the system as large particles but is likely to collapse during the process, would there be

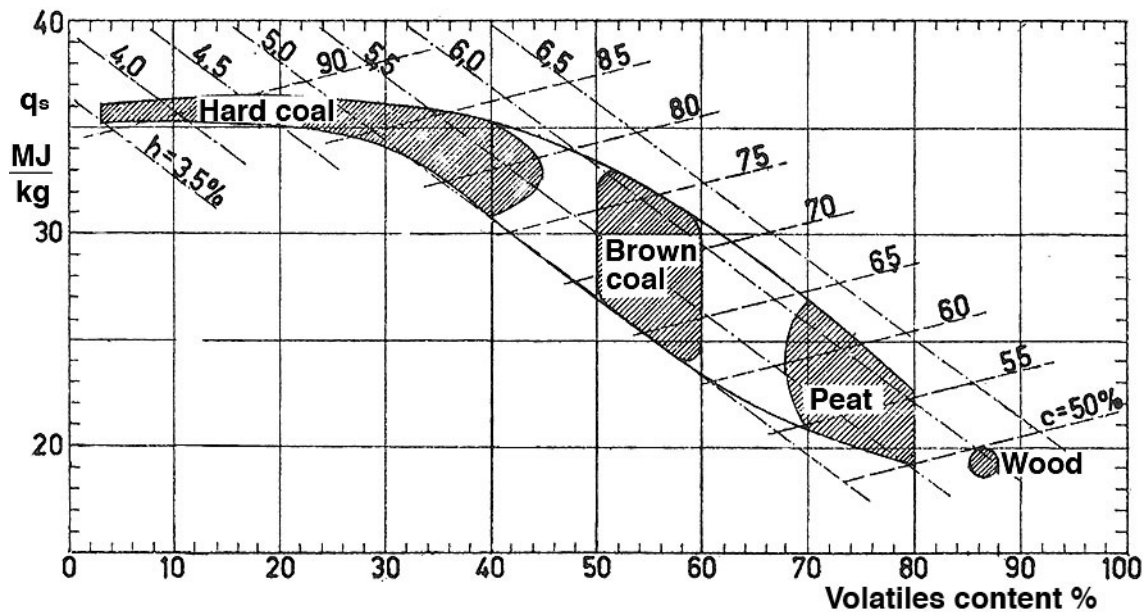

Figure 3.1: Heating value for certain biomass-based fuels plotted against their volatiles content [7, p. 569]. In the figure are also shown carbon and hydrogen content of the fuel in mass percentage.

a strong possibility of channeling and bridging. Pellets are a typical example of such fuel.

Reactivity of the biomass indicates how fast and intensively it will react in given conditions. Reactivity, among ash properties of a feedstock will mostly determine how easy the feedstock is to gasify: a reactive biomass with ash of high melting point will be easy to gasify, and on the contrary a biomass with low reactivity and low melting point of ash will be rather difficult to operate with; a case with reactive biomass and a low melting point ash is handled by bringing the reactor temperature down [8].

Moisture content of the biomass will affect the product gas composition, not only the H_2O content but also CO/H_2 ratio as can be seen from reaction (2.7). Also, the more water is taken into the reactor, the more air is required to the reactor to produce heat to evaporate the moisture. Unnecessary evaporation will hence lower the product gas heating value and cold gas efficiency.

Volatile matter content, among moisture, fixed carbon and ash content in a feedstock will be determined by *proximate analysis*. The ratio of volatiles to fixed carbon is an indicator of the biomass reactivity, as volatile compounds tend to react more rapidly than fixed carbon. Average results from proximate as well as *ultimate*

Table 3.1: Average properties of biomass feedstocks, presented in relation to weight of dry fuel. Oxygen content is determined by the difference from unity. [8]

	Ash	Volatiles	Fixed carbon	HHV	LHV
	%	%	%	MJ/kg	MJ/kg
Minimum	0.08	73.0	16.8	18.06	16.75
Maximum	8.9	83.1	25.3	20.95	19.70
Average	3.1	77.8	19.1	19.54	18.29

	C	H	N	O	S	Na	K	Cl
	%	%	%	%	%	ppb	ppb	ppb
Minimum	45.0	5.7	0.08	38.2	0	20	480	37
Maximum	52.5	6.1	1.4	42.8	0.55	678	12188	3266
Average	49.0	5.9	0.6	41.3	0.10	201	4687	1242

Table 3.2: Inorganic substances in biomass in weight percentage [8].

	Ash content		Ash composition								
	%		%								
	SiO ₂	Al ₂ O ₃	Fe ₂ O ₃	CaO	MgO	K ₂ O	Na ₂ O	TiO ₂	SO ₃	P ₂ O ₅	
Pine, saw dust	0.1	8.3	2.0	1.8	41.8	11.8	12.3	0.3	0.12	1.9	5.2
Pine, bark	1.7	1.3	5.3	0.3	40.6	4.5	7.6	0.5	0.12	2.0	4.8
Pine, forest residue	1.3	38.5	4.7	3.7	15.4	4.0	8.3	0.4	0.50	1.6	3.2
Willow	1.2	0.4	0.3	0.2	30.8	5.1	26.5	0.3	0.02	3.0	11.5
Wheat straw	4.7	59.9	0.8	0.5	7.3	1.8	16.9	0.5	0.04	1.1	2.3
Barley straw	5.9	62.0	0.2	0.2	4.5	2.2	19.3	0.5	0.02	1.4	2.5
Reed canary grass	8.9	89.8	1.4	1.1	3.5	1.5	3.1	0.1	0.05	1.1	4.1
Miscantus	3.3	42.8	0.5	0.4	7.6	4.8	25.3	0.7	0.03	2.1	5.3
Sweet sorghum	4.7	57.8	0.7	0.5	9.0	2.7	8.2	1.5	0.05	3.0	3.0
Kenaf	3.6	6.6	1.8	1.2	30.8	6.0	13.3	1.3	0.08	5.7	2.7

analysis for general biomass feedstock is presented in Table 3.1, more exact values can be found for example in [9, 10].

Elemental composition of the feedstock is determined by ultimate analysis, an example of which is given in Table 3.1. The thing that is particularly interesting with respect to gasification systems, is the ash composition. In Table 3.2 are given mineral content of some biomasses that might be used in a gasification plant. It is to be seen that fast growing biomasses contain a lot of SiO₂ whereas the ash of woody substances is mostly CaO.

It is very important to know the properties of the ash when designing and operating gasification and combustion systems. Certain minerals have rather low melting points and if the conditions are favourable, these minerals will start melting which will lead into bed sintering, agglomeration and eventually defluidization in a fluidized bed gasifier [11]. Even though the melting of the ash is undesired in other

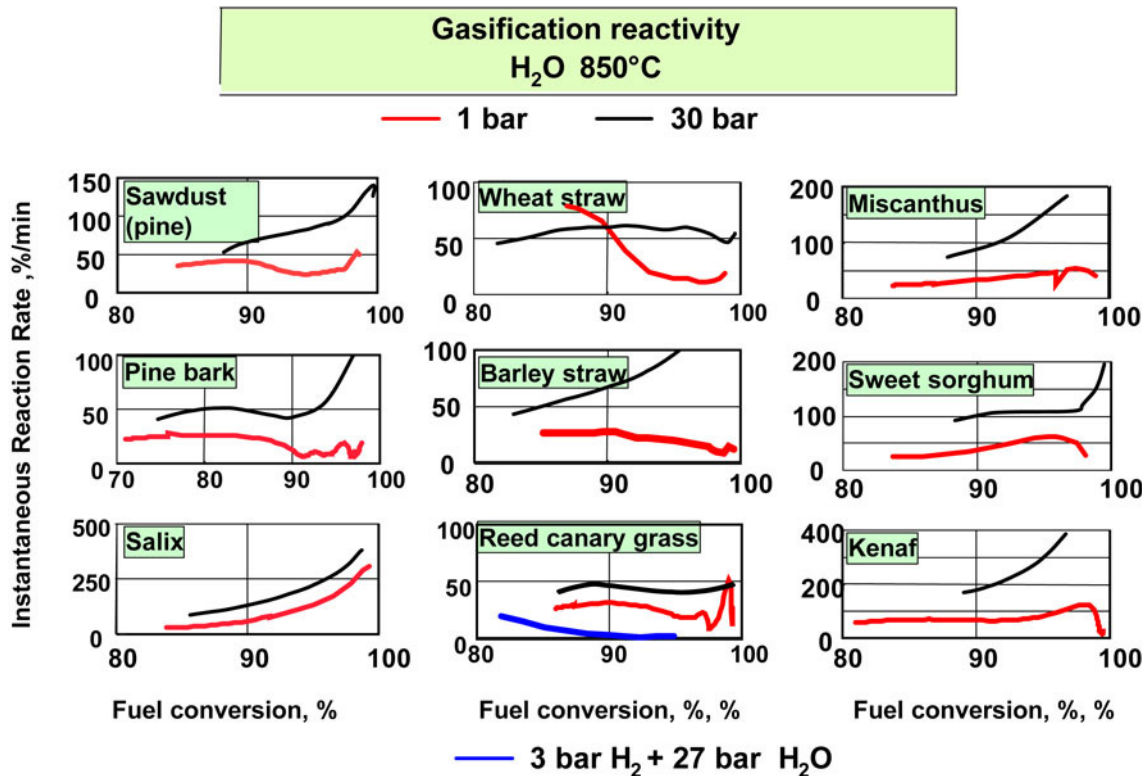

Figure 3.2: Instantaneous reaction rates of various biomasses under different circumstances plotted against fuel conversion [13].

types of gasifiers, in an entrained flow gasifier it is necessary for the gasifier to stay operational. In such cases, feedstocks with low melting point are preferred.

The most problematic minerals with respect to ash melting are alkali silicates and to lesser extent other oxides or alkali salts [11]. In Table 3.2 columns that indicate the melting properties best are the ones of SiO₂ and K₂O [8], which together form (K₂O·SiO₂)₍₁₎, a glass-like substance with low melting point and high viscosity [11].

Alkaline and earth-alkaline compounds in the ash act also as catalysts in the char reactions, thus contributing to reactivity and *carbon conversion* of the feedstock. Other aspects affecting the reactivity are temperature and partial pressures of H₂O, CO₂, H₂ and CO. [12]

The instantaneous reactivity of the feedstock can be plotted as a function of fuel conversion, yielding figures such as presented in Figure 3.2. Looking at these, it becomes very clear that different fuels react in the gasifier very differently, and that the operation must be planned accordingly. Also it can be seen from the subfigure for reed canary grass that hydrogen works efficiently as an inhibitor to the gasification reaction.

The ultimate decision on the feedstock that will be used in the gasifier depends on many factors of which economy is one. If the product gas is to be used in boilers

for heat generation, the most affordable fuel that is available is likely to be chosen. In most cases it means lowest quality biomass with which the gasifier is still operable. However, in the other end of the scale, if the product gas is to be reformed to syngas and used as raw material in chemical industry, the requirements for the gasifier feedstock will be stricter.

4 Gasification Processes

Gasification processes can be classified in several ways. Most commonly this classification is done by gasification agent, by heat source, by operational pressure or by gasifier design [14]. The gasification agent can be either air, oxygen, steam, carbon dioxide or a combination of the previous. Whilst the cost of air is practically next to nothing, it contains very much nitrogen that does not contribute to gasification, but only increases the mass flow of the product gas and lowers its heating value. If the product gas is to be used as fuel gas for a kiln or boiler, this behaviour can be tolerable, but should the gas be reformed into syngas, the usage of pure oxygen as oxidizer can in many cases be a better alternative.

Gasifying with oxygen produces a better quality gas, but the costs related to the gasification agent will be significantly higher. Oxygen gasification is used mostly with coal and heavy oil [15], especially in entrained flow gasifiers, where the temperature of the reactor is very high and the usage of air as oxidant would result in lowered temperature. This would in turn require more air to the reactor to produce heat, and in the end the gas quality could be unacceptably low.

Using steam as the gasification agent results mainly in production of hydrogen and carbon monoxide as is described in reaction (2.5). The reaction is endothermic, which means that heat has to be applied to the system. One solution is to use an external heat source, another is to provide the necessary heat indirectly. Optionally, a mixture of steam and oxygen or air may be used, so that the reactions of oxygen produce the necessary heat. The heating value and the hydrogen content of the product gas will be fairly high when gasifying with steam, but so will also be the tar content, thus implying the need for catalytic gas reforming [16].

Carbon dioxide can also be used as a gasification agent, similarly to steam. The CO_2 has an ability to convert char, tar, and CH_4 into CO and H_2 , assuming the presence of catalyst, which means that the yield of CO and H_2 will be larger than usual [14]. The main reaction here is also endothermic (reaction (2.4)), and the same means of heat input can be applied as with steam gasification.

There is also a possibility of combining the above mentioned gasification agents, the most common combination is steam and air or oxygen. The agents may be introduced together in the same stage, but also separately. Indirect gasification is an example of such a process, this is more closely explained in Chapter 6 with proprietary SilvaGas and FICFB processes.

Regarding the categorization based on the heat source, indirect gasifiers are classified as *allothermal*, whereas gasifiers that produce their own heat are classified as *autothermal*. Simply put, the former need heat energy from outside and the latter can provide all the heat that is necessary for the operation.

Many subsequent applications to gasification require elevated product gas pressure, for example IGCC or chemical production [17]. In many cases it is more economical to pressurize the feed to the reactor than to pressurize the product gas, even though it might be rather complicated at high pressures. The volume of the reactor also decreases with increasing pressure, thus reducing costs related to the physical size of the reactor. [1, pp. 193–194] Pressure also affects the product gas composition according to Le Châtelier’s principle: the increase in pressure shifts the equilibrium of individual reactions towards the side with less number of gas moles. As can be deduced from Figure 3.2, the reaction rates are also highly dependent on the gasification pressure, mainly so that increase in pressure accelerates the reactions.

The gasification reactors can yet be classified based on their design, which normally is their most distinctive feature. In the following sections the most common reactor designs are reviewed and their properties are discussed.

4.1 Fixed Bed Gasifiers

The fixed bed gasifier is the simplest and oldest type of gasifier. In a fixed bed gasifier the feedstock is introduced into a vertical container, in the bottom part of which the gasification reactions happen. As the biomass is consumed, the bed moves slowly downwards and the individual particles go through different stages of the gasification process; due to this behaviour, fixed bed gasifiers are also commonly referred to as moving bed gasifiers. There are distinct layers in the gasifier where demoisturizing, devolatilization, reduction and oxidation happen subsequently.

Fixed bed gasifiers are generally rather inexpensive and simple. They have high overall carbon conversion, high residence time of solids and low gas velocity, but have limited scalability [14]. There are four main types of fixed bed gasifiers, which are updraught, downdraught, cross-draught and open-core fixed bed gasifiers [18, pp. 27–29].

4.1.1 Updraught Fixed Bed Gasifier

Updraught or counter-current fixed bed gasifier is the simplest gasifier available. Its operation is depicted in Figure 4.1: Air or mixture of air and steam is introduced to the system at the bottom of the reactor. It interacts first with char and produces carbon dioxide. The combustion products then enter the reduction zone, where CO_2

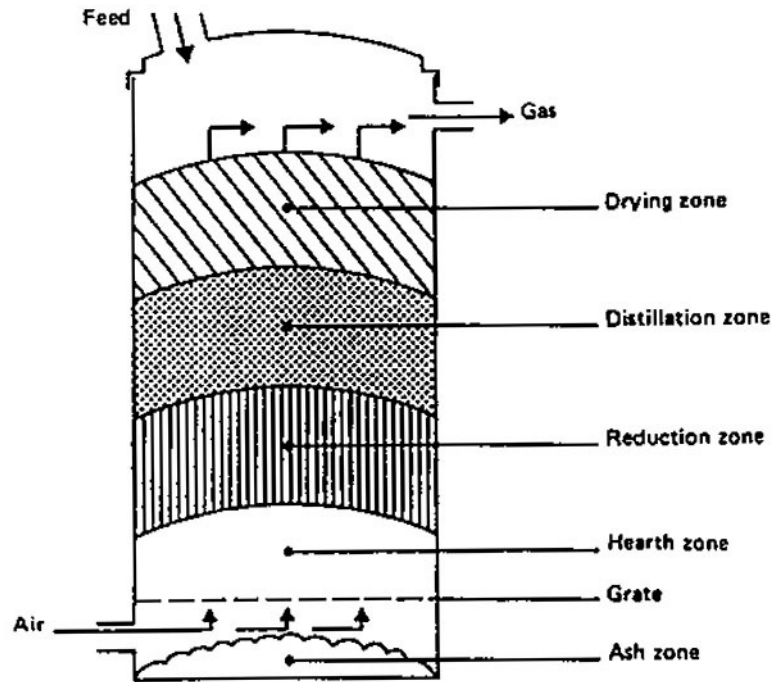

Figure 4.1: Updraught fixed bed gasifier [19, p. 22].

reacts with hot char and forms carbon monoxide; also other reduction reactions take place. The product gas then passes through the pyrolysis zone, where the heat of the gas evaporates the volatile compounds in the biomass. Lastly the remaining heat of the product gas is used to evaporate the moisture.

This is a very effective way of gasifying the biomass. Due to the counter-current flow of the media, most of the heat that is produced in the partial oxidation is used to evaporate volatiles or water. The product gas exits at a temperature of 200–400 °C, which results in high thermal efficiency. Because the dehumidification is efficient, biomass with up to 60 % moisture content on wet basis can be used. The carbon conversion of the gasifier is also very good and some variation in the particle size is allowable. The size of the feedstock may range from 5 mm to 100 mm. [18, p. 27, 31] There is however a major disadvantage related to the updraught fixed bed gasifier: The tar and hydrocarbon content of the product gas is very high, because the pyrolysis products do not react in the gasifier sufficiently.

The tar content of the product gas restricts the usage of updraught fixed bed gasifiers to fuel gas production. These gasifiers have been successfully applied commercially, examples of such are German Lurgi fixed bed gasifiers dating from 1936 onwards [1, p. 94] and Finnish Bioneer gasifiers that were developed in the 1980's for district heating purposes [20].

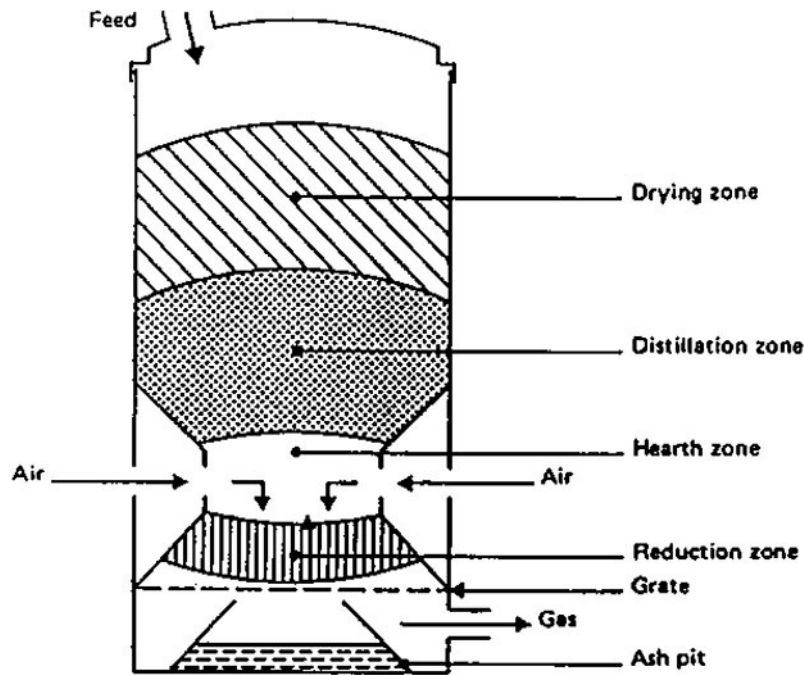

Figure 4.2: Downdraught fixed bed gasifier [19, p. 23].

4.1.2 Downdraught Fixed Bed Gasifier

Downdraught or co-current fixed bed gasifiers differ from updraught fixed bed gasifiers in the way that the gasification agent is introduced to the system. In downdraught gasifiers the agent is fed in at the top or at the sides of the reactor, so that it runs co-currently with the biomass. There are similar distinct reaction zones as in updraught gasifiers, but they appear in a different order. As the feedstock is fed into the reactor, it begins to dry in the first stage and then to pyrolyze. The heat that is needed to evaporate the water and the volatiles is mainly transferred in the form of radiation, and to lesser extent convection [18, p. 28]. The water vapour and the pyrolysis products pass through the oxidation zone, in which a part of them are reacted. All combustion and evaporation products pass through the reduction zone that lies under the oxidation region. Here the gases react with hot char and produce CO, H₂ and such. A schematic view of the reactor is presented in Figure 4.2.

The heat transfer between the hot and cold zones of the downdraught fixed bed gasifier is very poor compared to updraught gasifiers. This results in lower acceptable fuel moisture content ($< 25\%$) [18, p. 31], since the excess water can not evaporate in required time. Tar content of the product gas is significantly lower than one coming from an updraught fixed bed gasifier because the pyrolysis products pass through the oxidation zone. However, the residence time in the oxidizing environment is too short for the tars to decompose thoroughly [18, p. 28] and the gas will not be completely free from tar. Hence, the gas has to be cleaned properly if it is to be used in critical applications. The temperature of the outgoing gas is high, about

700 °C [18, p. 31], which results in lower cold gas efficiency than what is achievable with updraught gasifiers. The product gas also includes high amounts of ash and dust, because the gas passes through the char bed on its way out, where some of the particles are entrained into the flow [18, p. 28].

Downdraught fixed bed gasifiers require very uniform size distribution of the biomass to prevent bridging and channeling in the reactor. The throat that locates itself at the oxidation zone easily produces blockages in the biomass flow, which disturb the internal gas and heat distribution of the reactor. The gasifier is operable with biomass whose particles range from 40 mm to 100 mm in diameter. [18, p. 28]

Downdraught fixed bed gasifiers are mostly used in engine applications because of their simplicity, low investment costs, reasonable quality product gas and possibility to low capacity installations.

4.1.3 Cross-Draught Fixed Bed Gasifier

Cross-draught fixed bed gasifier is a modification of the downdraught gasifier, here the gasification agent is introduced in one side of the reactor and the flue gas exits at the other side; see Figure 4.3 for schematic view. Cross-draught gasifiers are practically used only in charcoal gasification, in which the temperature is very high, around 1500 °C. The high local temperature would result in vast material problems in other types of fixed bed gasifiers, but in this application the feedstock layer acts itself as an insulation against the high temperatures. Cross-draught gasifiers have very low tar-converting capability, which means that the used charcoal must be of a very high quality if the product gas is wished to be used in internal combustion engines. [19, p. 24]

4.1.4 Open-Core Fixed Bed Gasifier

Open-core fixed bed gasifiers — like cross-draught gasifiers — are aimed at a very specific application, namely the gasification of loose bulk material such as rice husks. The open-core gasifiers contain no throat so the bridging is less significant than in downdraught gasifiers, however there might be a need to implement a rotating grate or similar method to keep the bed in motion. Especially rice husks need a continuous ash removal system because of the very high ash content of the feedstock. Figure 4.4 is an illustration of an open-core fixed bed gasifier, here the ash is collected into a water basin from where the ash is transported away as a suspension. [18, pp. 28–29]

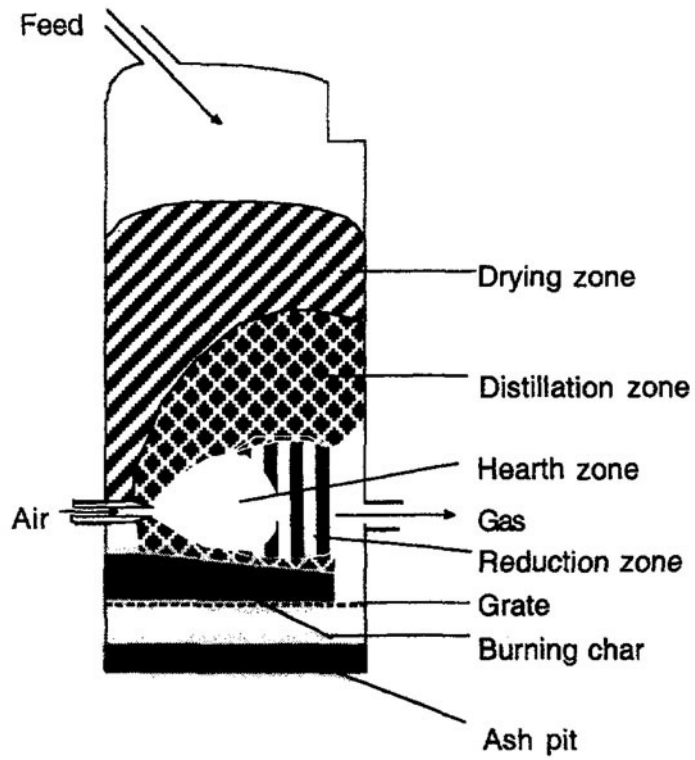

Figure 4.3: Cross-draught fixed bed gasifier [18, p. 29].

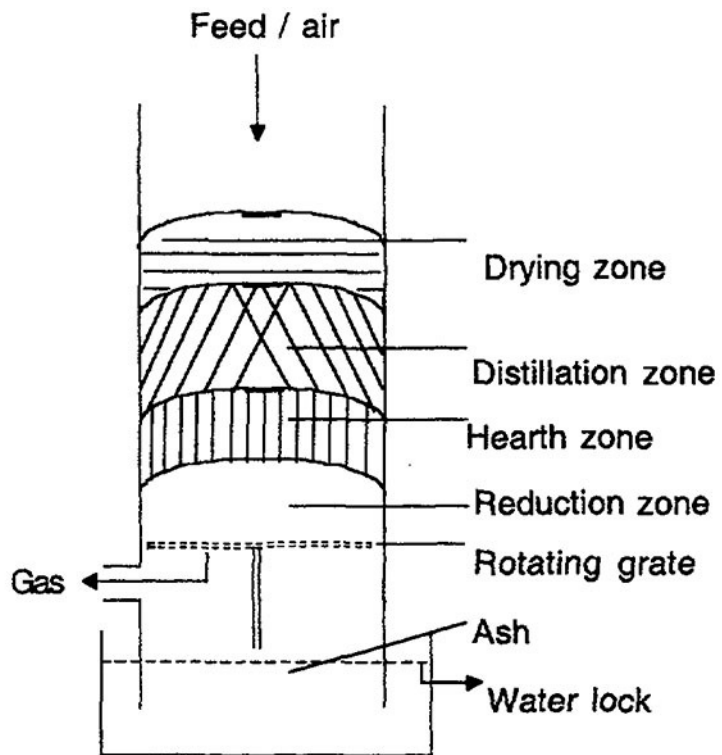

Figure 4.4: Open-core fixed bed gasifier [18, p. 29].

4.2 Fluidized Bed Gasifiers

Fluidized bed technology was first applied to biomass gasification in the early 1980's by Lurgi and Ahlström. It has many advantages over more conventional fixed bed technology, for instance the ability to handle high throughput, superior up-scaling potential and wide feedstock basis. Atmospheric circulating fluidized bed (CFB) gasification is considered as the preferred technology in nearly all medium-to-large scale biomass gasification plants for power production. [5]

In a fluidized bed gasifier the feedstock is applied to a large volume of bed material that is kept in a fluid-like state by the means of gasification agent injection underneath the bed. In a bubbling fluidized bed (BFB) gasifier the fluidization velocity is 1–3 m/s and in CFB gasifier it is 5–10 m/s [15]. This difference results in distinction of the bed behaviour between these two main subtypes: in a BFB the bed remains relatively still and bubbles similarly to a porridge in a kettle, as in a CFB the bed material occupies the whole volume of the boiler and there is no distinct freeboard region. The bed material of a CFB gasifier is removed from the product gas in a cyclone and is returned to the bottom of the bed.

As the biomass enters the gasifier, it is heated up very quickly to the bed temperature due to the large heat capacity and the movement of the bed. This results in fast drying and pyrolysis [19, p. 24], after which the volatiles continue to react in gaseous phase. The char particles remain in the bed, where they are ground by abrasive effect of the bed material, hence revealing unreacted char. The char is partly combusted in the bed, thus producing heat for endothermic gasification reactions.

The temperature of the bed is rather constant due to the good mixing. This temperature is wanted to be kept as high as possible but yet below ash softening temperature, which is typically in the range 800–950 °C for biomass [1, p. 106]. The temperature is fairly low compared to the one of the oxidation zone in fixed bed gasifiers, which helps to prevent problems related to ash melting [16]. With some fuels though additional means of hindering ash melting must be applied to keep the bed material from sintering. Examples of such are using kaolin or lime as an additive, using alumina sand as bed material and adding alkali earth metals to the bed. [11] The product gas leaves at a temperature similar of the bed's, which leaves the energy affiliated to the latent heat of the gas unused if the gas is not used immediately.

The low reactor temperature also affects negatively on tar cracking, so the tar content of the product gas will be somewhat between that of updraught and downdraught fixed bed gasifiers [21]. The tar can be removed after the gasifier, but also directly in the reactor [22]. The bed material can be either inert or active as

regards to this tar removal; quartzite is a commonly used inert bed material, whereas olivine, dolomite and Ni-alumina are active in catalyzing the tar decomposing. With Ni-alumina bed, tar concentration can be reduced by 50 % compared to quartzite bed. [23]

The almost ideal mixing that is characteristic to fluidized bed gasifiers has also disadvantages, namely it results in incomplete carbon conversion. The char particles are distributed evenly in the bed regardless of the residence time, thus the removal of fully reacted particles leads to removal of unreacted char. [1, p. 107] The carbon conversion in CFB gasifiers is considerably better than in BFB gasifiers. The vigorous mixing also causes small particles to be entrained in the flow, hence the particulate content of the gas will be high [18, p. 32].

The feedstock particle size in fluidized bed gasifiers is normally below 20 mm, which is somewhat smaller than with fixed bed gasifiers. Fluidized bed technology however enables gasification of fine and low-density material. The installations of fluidized bed gasifiers are mainly larger than with fixed bed technology, typically over 1 MW_{th}. [18, pp. 32–33] Fluidized bed gasifiers offer high fuel flexibility [14].

4.2.1 Bubbling Fluidized Bed Gasifier

A very schematic view of a bubbling fluidized bed (BFB) gasifier is presented in Figure 4.5. The gasification agent is primarily led into the gasifier at a distributor plate on the bottom. The air forms a suspension with the bed material, which acts like a boiling fluid. The feedstock is introduced to the bed, which forms a distinct interface with the freeboard region that locates itself above the bed. Some additional oxidizing agent might be fed in in the freeboard region to assist gasification of small, entrained particles [1, p. 108]. Some char and ash particles leave the gasifier in order to be collected in a cyclone after the reactor. The solid matter may be reintroduced to the bed or taken away as fly ash.

4.2.2 Circulating Fluidized Bed Gasifier

A circulating fluidized bed (CFB) gasifier is depicted in Figure 4.6. The feedstock is fed into the bed, which is fluidized with gasification agent similarly to a BFB installation. Due to the larger fluidization velocity, the formed suspension occupies the whole volume of the reactor; the entrained ash and char particles are removed from the flow in a cyclone located after the actual reactor. The matter that is collected in the cyclone is returned to the bed, thus extending the residence time of the solids.

Circulating fluidized bed gasifiers are being commercially applied to biomass gasification, one commonly used example is Lahti Energia Oy's Kymijärvi power

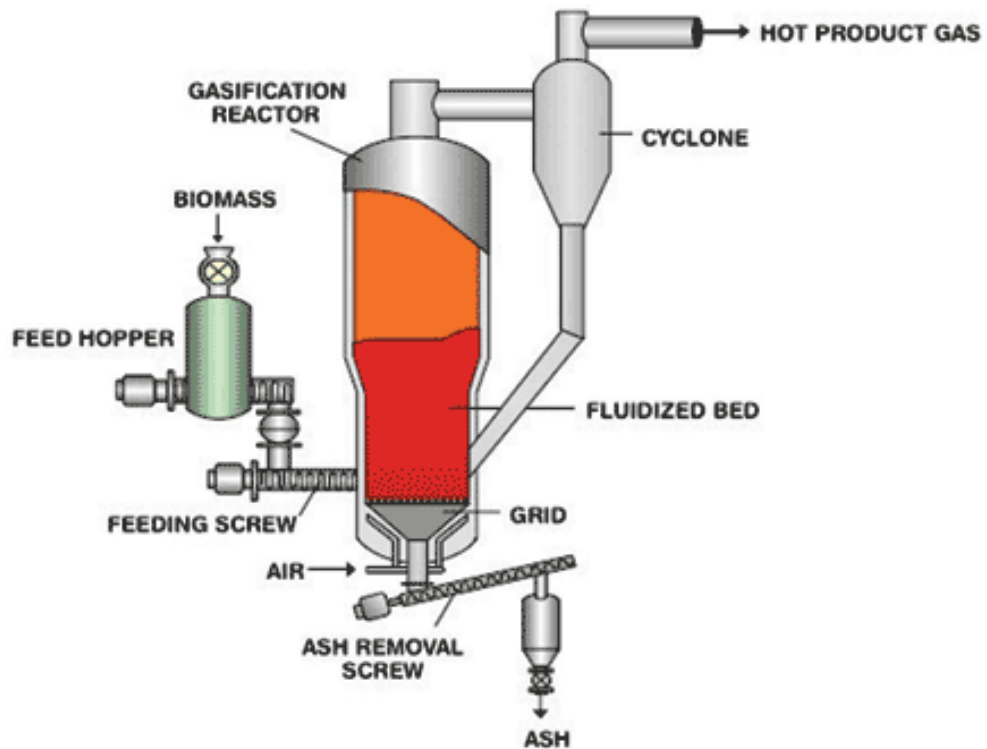

Figure 4.5: Bubbling fluidized bed gasifier [24].

plant in Lahti, Finland, in which product gas is co-fired in a pulverized coal fired boiler. The feedstock is a variable mixture of refuse derived fuel and biomass. [25] The Kymijärvi power plant will be more thoroughly discussed in Chapter 6, Subsection 6.2.1.

4.3 Entrained Flow Gasifiers

In an entrained flow gasifier, the feedstock is introduced to the reactor as very fine particles, either dry or suspended in water. The particles are gasified very rapidly in a temperature of over 1400 °C, usually with oxygen or with a mixture of oxygen and steam. The high temperature results in melting of the ash, which is then cooled and collected at the bottom of the gasifier as flowing or vitrified slag. [1, pp. 120–122] In Figure 4.7 is a schematical presentation of a Siemens entrained flow gasifier.

Entrained flow gasification is the preferred gasification technology for hard coals. It is suitable for large installations and the carbon conversion and the product gas quality are very high [1, pp. 120–122]. Biomass utilization in entrained flow gasifiers has not yet gained much popularity due to the need for complex feedstock preparation, but some solutions have been presented [15]. One example is the Choren Carbo-V[®] process, in which the biomass is pyrolyzed before the entrained flow reactor. This particular process is further analyzed in Section 6.1.

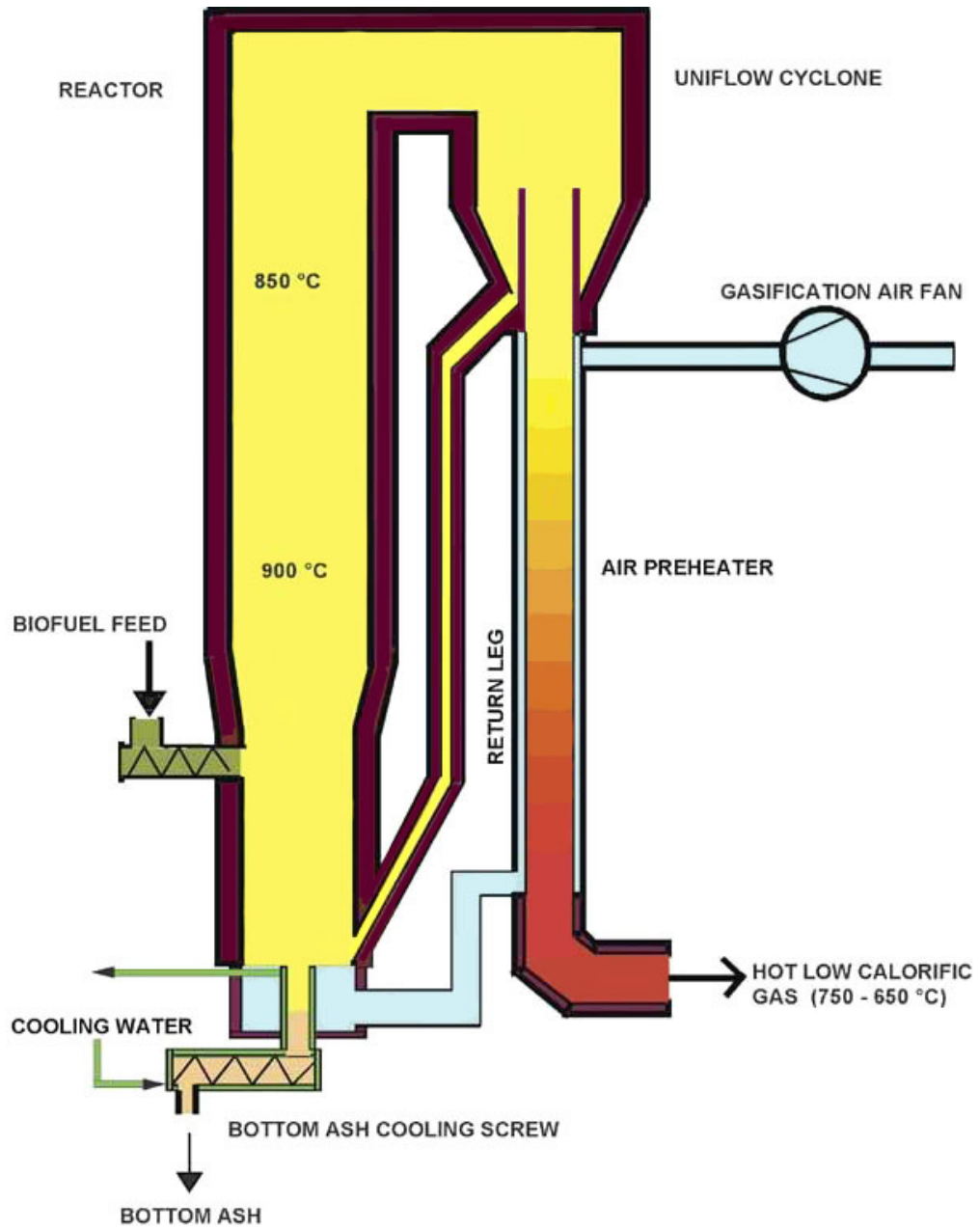

Figure 4.6: Circulating fluidized bed gasifier [26].

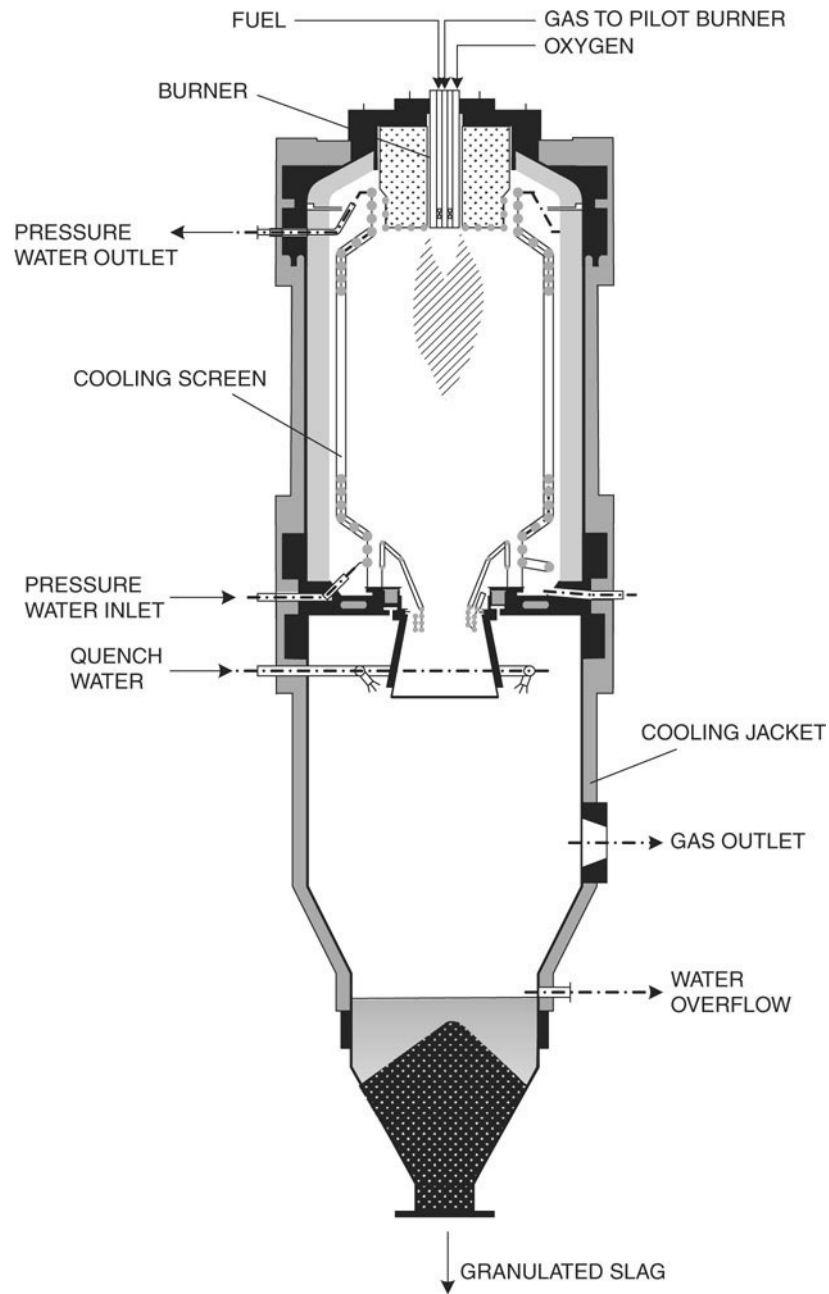

Figure 4.7: Entrained flow gasifier [1, p. 133].

Entrained flow technology has also been applied to black liquor gasification in demonstration scale. A 3 MW Chemrec pressurized oxygen-blown gasifier has been investigated for the chemical recovery process of a pulp mill and the production of high-quality synthesis gas in Piteå, Sweden. Based on the results obtained, a larger scale plant is under construction to Domsjö mill, Örnsköldsvik, Sweden. [27]

5 The Product Gas

In this chapter, the product gas will be discussed more thoroughly. In Section 5.1 the average composition of the product gas is discussed and the factors that affect the composition are reviewed. The cleaning of the product gas is then discussed in Section 5.2, and lastly, in Section 5.3 the applications of the gas are shortly described.

5.1 Product Gas Composition

The product gas consists mainly of carbon monoxide, hydrogen, methane, carbon dioxide and possibly nitrogen if air is used as the gasification agent. Example product gas compositions are given in Table 5.1. CO₂ and N₂ are generally undesirable in the product gas, since they do not contribute to the heating value but only increase the volume flow. When synthesis gas or hydrogen is the targeted end product, methane is also an unwanted species. The balance between the species can however be affected by altering the circumstances within the gasifier or by catalytic reforming after the initial reactor.

In addition to the main components the product gas contains for example particles, alkali and heavy metals, tars, nitrogen and sulphur compounds and hydrochloric acid. Thus, the gas has to be cleaned before further usage, unless it is immediately burned in a boiler. The cleaning is most essential in demanding applications, such as engine, fuel cell or synthesis applications. [15]

Tar is a variable mixture of condensable hydrocarbons that is produced in practically all biomass gasification. There is no unambiguous definition of tar, but in gasification all organic contaminants with a molecular weight larger than benzene are generally regarded as tar [30, 31]. The amount of tars in product gas depends on many things, but it can be approximately in range 0.15–100 g/m³ [18, p. 31], while the allowable concentration for engine or other applications that require low tar content could be of the order 50 mg/m³ or less [30, 32].

It is undesirable to have excess tar in product gas, since it will condense at surfaces that are colder than the dew point of the tar and foul and block process equipment like nozzles, filters and turbines [32]. The product gas from a down-draught fixed bed gasifier may be used in a robust piston engine after a light cleaning, but as the pressure increases, the condensation of tar compounds becomes more

Table 5.1: Examples of product gas composition, measured in volume percentage of dry product gas. In the first column is presented data for assorted woody biomass with 20 % moisture content gasified in a downdraught air-fired reactor. In the second column is data for various residual biomasses that are gasified in a CFB reactor with air, their moisture is in the range 3–17 %. In the third column is data for rice husks with 10 % moisture content that are gasified in a steam-operated BFB gasifier, and in the fourth column is data for rice husks and wood dust with moisture content of 5–12 % that were gasified in a dry entrained flow gasifier with O₂ as gasification agent.

Species	Content vol-%			
CO	17–22	5–12	14–24	23–55
H ₂	12–20	6–9	50–54	7–48
CH ₄	2–3	1–3	6–9	0–8
CO ₂	9–15	14–17	19–27	3–67
N ₂	50–54	59–74	0	0
Reference	[19]	[10]	[28]	[29]

severe [15]. In synthesis applications tar is considered as contaminant, among all other substances except CO and H₂ [1, p. 217].

The composition of the product gas is not only dependent on the said gasifier and the feedstock, but also on the residence time, gasification agent, oxygen-to-carbon ratio and operating pressure and temperature; that is, the optimization and the operation practice of the gasifier. The dependence on the residence time is most apparent in entrained flow gasifiers: should the residence time be too short, the particles would not have enough time to react thoroughly. This would result in low carbon conversion and a gas composition not near the equilibrium value. Too high a residence time would again be of no benefit but only reduce the throughput of the gasifier. [29]

The gasification agent affects the product gas composition as was described in Chapter 4. The moisture of the biomass has the same effect on the composition as steam injection: adding H₂O results in H₂ and CO production in accordance to reaction (2.5). While keeping the oxygen-to-carbon ratio constant and thus decreasing the air flow in purely air-blown processes, the heating value of the gas is increased. The overall composition is altered by the steam injection, mostly due to reactions (2.7) and (2.8): more hydrogen is produced at the expense of carbon monoxide and methane production. The temperature in the gasifier decreases with increasing water content because of the endothermic reactions of water. [33]

Oxygen-to-carbon ratio affects the operation of the gasifier very much. In air- or oxygen-operated gasifiers it is comparable to the air factor of the system; in

systems with H_2O or CO_2 as gasification agent the air factor is however undefined. As the O/C ratio is increased, more carbon is reacted. In the same time, the ratio of CO_2 to CO increases as the O/C ratio approaches the stoichiometric value. This results in decrease in the heating value of the gas with increasing oxygen-to-carbon ratio. The ratio of hydrogen to carbon monoxide concentration decreases with increasing O/C ratio. [29]

Pressure affects the gas composition and reaction rate. As the pressure is increased, the reactions are shifted to the direction with less number of gas moles, according to Le Châtelier's principle. Hydrogen and carbon monoxide production prefer lower pressure whereas more methane is formed in high pressure conditions [17]. Variation in temperature has similar effects to the pressure change: the yield of H_2 and CO are higher in elevated temperatures, and the yield of CO_2 and CH_4 are higher in lower temperatures [17,29]. This is also partly explained by Le Châtelier's principle, as the endothermic reactions are favoured in higher temperatures and exothermic reactions in lower temperatures.

As the temperature increases, the tar content of the product gas is decreased because of increased cracking reactions [33]. At the same time the cold gas efficiency increases [29], which is due to increased hydrogen and carbon monoxide production.

5.2 Product Gas Cleaning

After the product gas exits the gasifier, it can be used in numerous applications. Excluding perhaps direct combustion, it has to be cleaned in all cases of the impurities it might contain. The cleaning methods may be divided into five categories: mechanism methods, self-modification, thermal cracking, catalyst cracking and plasma methods [32]. Cracking only applicable to tar removal, but mechanism and plasma methods can also be used in particle capture and self-modification in sulphur removal.

Before any removal processes the product gas has to be cooled down to the operating temperatures. Even the hot filtering systems operate at temperatures below $500\text{ }^\circ\text{C}$, thus the need for cooling exists in nearly all applications. In many cases the heat can be used to generate steam for other processes. [1, p. 220]

The mechanism methods include cyclones, filters, electrostatic precipitators (ESP) and scrubbers. Cyclones are an inexpensive way of removing particles, and they are commonly used as the first cleaning stage after the gasifier. The separation efficiency however decreases with decreasing particle size, and particles smaller than $5\text{ }\mu\text{m}$ are not captured. This implies the need for consequent particle removal systems, since such particles can be harmful to following processes [34].

There are many different kinds of filters, of which the candle filter is considered the most significant. These ceramic or sintered metal filters can remove practically all solids from the gas at high temperatures [1, p. 224], [34]. Fabric filters and bag filters can as well be used, but they are operable at a much lower temperature. Granular bed filters might also be applied to the product gas cleaning with for example activated carbon bed.

Electrostatic precipitators are very commonly used in particle collection applications in power plants and within industry, because of their high efficiency and low operating costs. ESPs have also been applied to product gas cleaning, with good success. More than 99 % dust and 40–70 % tar removal have been reported, with no apparent fouling at the particle collector plates. [32]

Scrubbers are used in most existing gasification plants for particle removal. The scrubbing takes place at temperatures lower than the dew point for the tars, so that the tars condense into the washing liquid. [1, p. 225] Scrubbing systems are very effective, but they are also rather expensive and the waste water treatment produces additional problems [32]. Scrubbers with oil solvent have been tested successfully; the OLGA process in particular has proven to be quite functional in laboratory and pilot scale [35]. It is common for every mechanism method that some metals and tars are as well removed during the process.

Self-modification is about changing the circumstances within the gasifier. Altering the operation parameters so that the thermal conversion of the tars is more rapid results obviously in less tars in the product gas. The parameters that affect the tar cracking are temperature, oxygen-to-carbon ratio, pressure, residence time, et cetera. Generally speaking, tar cracking and reforming are promoted by increased temperature, increased O/C ratio, increased pressure and prolonged residence time. [32] Adding for example dolomite into a fluidized bed not only catalyzes tar decomposing [23] but also helps to remove sulphur from the product gas [36, p. 3-42].

Tar can yet be removed by thermal or catalytic cracking after the gasifier. In thermal cracking, the temperature of the product gas is elevated to around 1000°C in an external reactor, where the gas stays for less than ten seconds. During this period, the tars ought to be decomposed or reformed into carbon monoxide, hydrogen and lighter hydrocarbons. [32,34] Lighter tar species decompose easily, but the more complex the structure, the more reluctant the tar is to crack. The high temperatures might cause additional material problems, thus implicating the need for more expensive reactor materials. Most problematic about thermal cracking is however the tendency to form soot in high temperature conditions. [34]

In catalytic conversion the reforming reactions happen in lower temperature levels than in thermal conversion, and on a catalyst surface. The catalyst may be

of a natural origin, for example dolomite and olivine. [16] These are also used as in-bed catalysts in fluidized bed gasifiers due to their low cost and reasonable catalytic activity [23]. Some metals, such as nickel and alkali metals, and alkalis, such as KOH and K_2CO_3 are also used as catalysts. Catalytic conversion methods have shown good tar removal efficiency. [16]

The plasma methods are an experimental way of removing tars from the product gas. Corona discharges have been shown to accelerate the tar decomposing reactions considerably, and to simultaneously help to remove particles. In a test conducted with a small biomass gasifier, a dust removal efficiency of 72–95 % and tar conversion efficiency of 50 % and 68 % for light and heavy tars was shown, respectively. The plasma methods can operate in high temperatures and can be retrofitted to existing installations. [32]

Further cleaning stages may be used, depending on the desired end product. Possible methods include acid gas removal, catalytic gas conditioning to modify the ratio of CO to H_2 , COS hydrolysis and methanation. CO_2 and other gases may be removed with cryogenic gas treatment, and sulphur may be recovered, with for example the Claus process. [1, pp. 328–365]

5.3 Utilization of the Product Gas

The applications for the product gas can be roughly divided into three categories that are power generation, fuel production and chemical production.

Power can be generated by combusting the product gas directly in a boiler, with little or no cleaning. This is a tempting application for such pulverized coal fired power plants that need to increase the biomass share of their primary energy consumption. If the biomass is conducted to existing coal mills and feeding systems, clogging problems are bound to arise if the share is too large. Co-firing gasified biomass circumvents these problems; neither do fouling and slagging appear to the same extent, because the biomass is gasified at a lower temperature than in which it would be otherwise combusted.

Power can as well be produced with integrated gasification combustion cycles and fuel cells, but the gas requires much more processing in these applications. In the biomass IGCC, the turbine is especially vulnerable against tars and particles; the fuel cells on the other hand can only convert hydrogen to electrical energy. Neither of these technologies have yet achieved large-scale commercial usage, but there is good potential because of their high energy efficiency and low emissions.

It is possible to produce high-quality fuels from synthesis gas, both gaseous and liquid. Hydrogen and methane are both components of the product gas and their yield can be favoured by changing the circumstances within the reactor and by

reforming reactions. Liquid fuels are obtainable through Fischer–Tropsch synthesis or other synthesis reactions; methanol for example is commonly produced from coal-originated synthesis gas [1, p. 264] and dimethyl ether (DME) is already manufactured from biomass based syngas [27].

Chemical production is very similar to fuel production, as for example methanol is an important intermediate in producing other chemicals. Ammonia is a very common compound that is produced from hydrogen, which is in turn obtainable from product gas. At the moment, over 90 % from produced ammonia is based on reforming methane or naphtha and almost all the rest is based on coal or heavy oil gasification. Carbon monoxide is also a raw material for numerous organic chemicals, like acetic acid and alcohols. [1, pp. 257–278]

6 Commercial Status of Biomass Gasification

Biomass gasification is still an emerging technology with a lot of research and development to be done before commercial breakthrough. The main challenges are tar reduction, gas cleaning and scaling up the technology. Gasification also needs to become more economically competitive to rival other methods for power generation and for fuel and chemical production. [5]

In this chapter biomass gasification is discussed from a commercial point of view. Some of the available processes are shortly reviewed and two biomass gasification cases are studied.

6.1 Commercially Available Gasification Processes

There are several companies that supply biomass gasifiers; the most well-known of these are Foster Wheeler AG and Andritz AG. Foster Wheeler offers CFB gasifiers, the largest installation to date is Lahti Energia's 40–70 MW gasifier. [1, p. 164] There is a broader selection within Andritz/Carbona gasifiers: besides CFB technology Andritz offers both atmospheric and pressurized BFB gasifiers [37]. Other manufacturers include Envirotherm GmbH that continues to produce Lurgi's CFB gasifiers [38], RenTech, Inc. that has its SilvaGas dual bed gasifier [39] and Choren Industries GmbH that has its Carbo-V[®] process [40].

Most of these technologies have been covered in this report except for the latter two, which will now be explained. SilvaGas is an indirect atmospheric two-stage gasifier with two CFB reactors; the process is schematically presented in Figure 6.1. The biomass is fed into the first reactor, where it is gasified with steam. The synthesis gas is extracted at a cyclone separator and the bed material is led to the second reactor. The char that did not react in the first gasifier is combusted here, thus warming the bed material. Flue gases are removed from the flow and the hot sand is led back to the first reactor, where the heat of the sand provides necessary energy to the endothermic gasification reactions. The SilvaGas process can give relatively nitrogen-free product gas without using oxygen as gasification agent. The tar content of the gas is typically about 16 g/m³. [1, pp. 166–169]

The Carbo-V[®] process is shown in Figure 6.2. It is a three-stage entrained flow

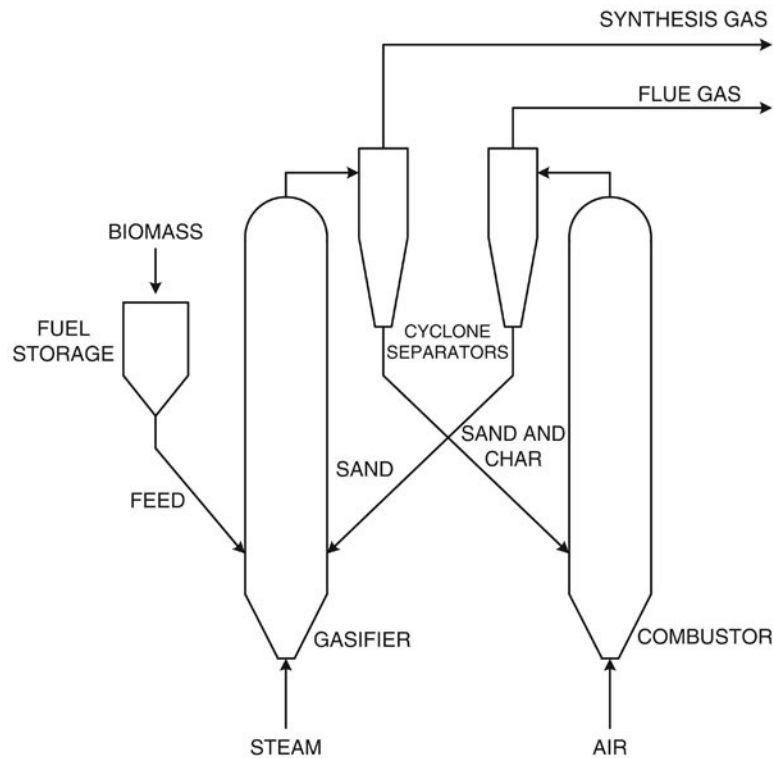

Figure 6.1: RenTech SilvaGas process [1, p. 168].

process which is especially designed to address the tar and feeding issues in biomass gasification. In the first stage pre-dried biomass is pyrolyzed in low temperature with air or oxygen. The volatiles are led to the combustion chamber of the two-part gasifier, where the volatiles are thoroughly broken down among char and ash from the third stage. The ash melts in these conditions and it is removed as vitrified slag. [40]

In the second part of the gasifier pre-milled char from the low-temperature gasifier is injected to the flow, where it reacts with carbon dioxide and produces CO [40]. The part of the char that is not reacted is removed after the following heat exchanger, and is led back to the high temperature part of the gasifier. Thus all of the biomass char goes through slagging environment. [1, pp. 171–172]

6.2 Case Studies

6.2.1 Kymijärvi Power Plant

The Kymijärvi power plant, operated by Lahti Energia Oy in Lahti, Finland, began its operations in 1975 as an oil-fired power station. In 1982 the fuel was changed to coal, and in 1992 a gas turbine was added to the plant configuration and additional natural gas burners were installed to the main boiler. In 1998 a circulating fluidized bed gasifier was added to the plant. The gasifier uses biomass and refuse-derived

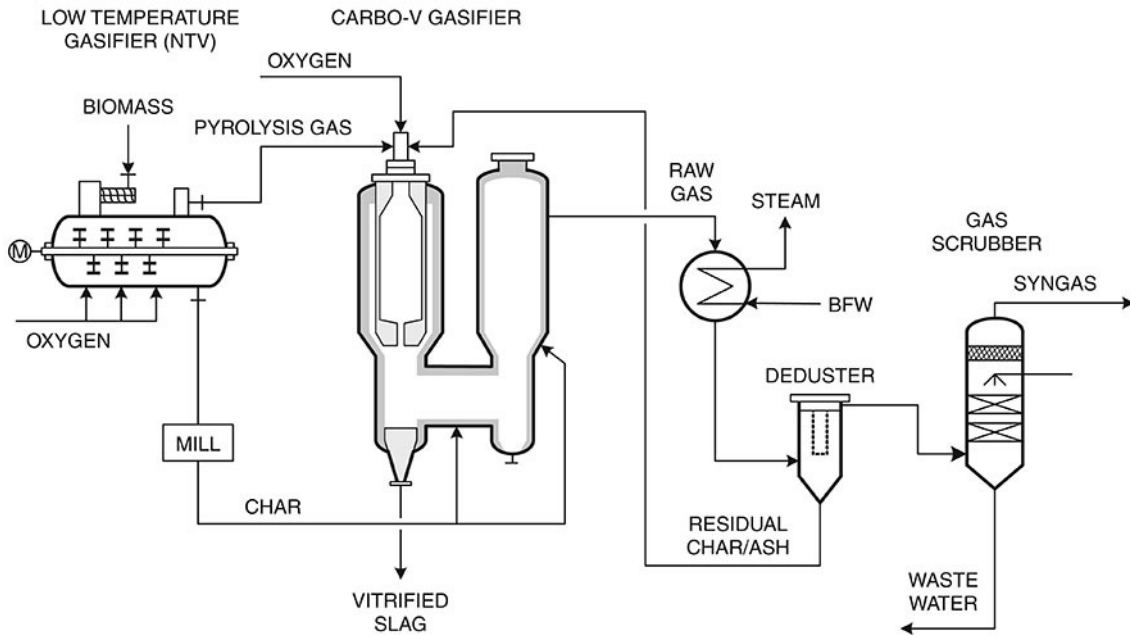

Figure 6.2: Choren Carbo-V[®] process [1, p. 171].

fuel (RDF) as feedstock; the product gas is co-combusted in the primary zone of the main boiler. [25]

The combined heat and power (CHP) plant is rated at 200 MW electrical power and 250 MW district heating capacity; on yearly basis this sums up to 700–1200 GWh electricity 1200 GWh district heating. The average yearly energy consumption is covered with 1700 GWh coal, 350 GWh product gas and 450 GWh natural gas, of which 300 GWh is used in the gas turbine. [25]

The installation, in which biomass and RDF originated product gas is co-combusted in a pulverized coal fired boiler, is unique. The Foster Wheeler CFB gasifier has been operated with various feedstocks, including wood, peat, plastic, RDF and crushed vehicle tyres. The operation of the gasifier has been trouble-free excluding some difficulties with the feeding system, that have already been solved. [25]

There is another gasification facility under construction to Lahti: in the LahtiStreams project two 80 MW_{th} Metso CFB RDF gasifiers, a fuel gas boiler, a steam cycle and appropriate accessories are going to be built in order to generate 42 MW electricity and 100 MW district heating. The power plant is going to be operable during spring 2012. [41, 42]

6.2.2 Güssing Power Plant

The gasifier in Güssing, Austria has much in common with the one in Lahti, but at the same time is very different regarding the scale of operation and the end use

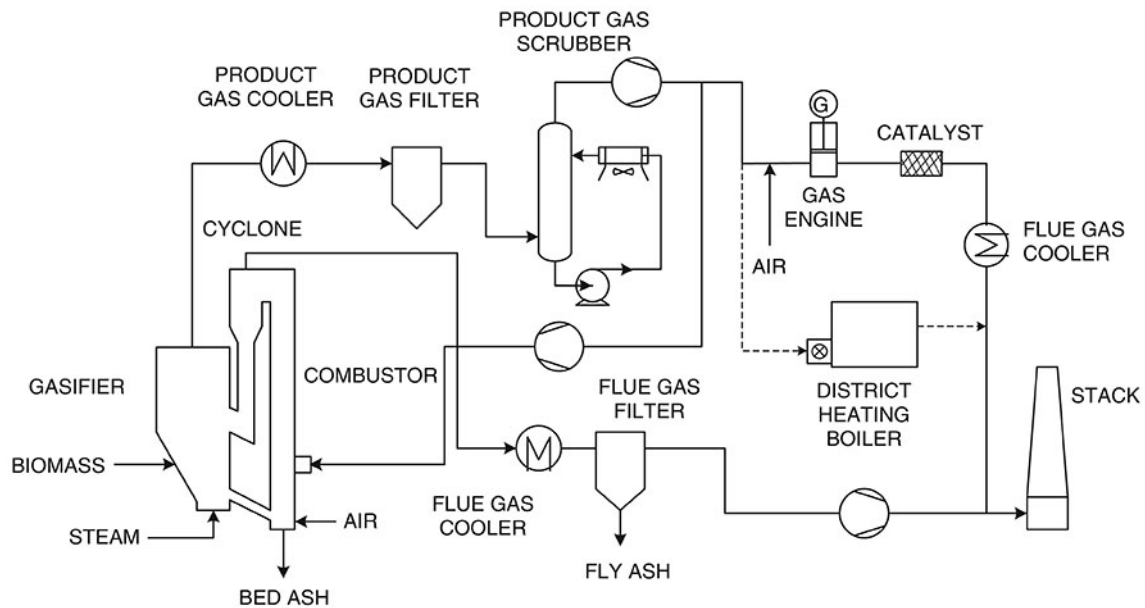

Figure 6.3: Güssing power plant flow chart [1, p. 169].

of the gas. The fast internal circulating fluidized bed (FICFB) process is developed by Vienna University of Technology to produce high heating value product gas with very small nitrogen content [43]. The process is depicted in Figure 6.3.

The FICFB is in principle quite similar to the SilvaGas process: the biomass is gasified with steam and the process heat is provided indirectly by combusting the remaining char. The difference lies in the reactor design; here the primary gasifier is of bubbling fluidized bed technology and the combustor has circulating fluidized bed. After the gasifier the product gas is cleaned and used in a gas engine to produce heat and power [43].

The power plant is of a rather small scale: the biomass input is 8 MW_{th} with which 2 MW electricity and 4.5 MW district heating are produced in the process. A lot of research is done on the facility: at least projects concerning electricity production in solid oxide fuel cells (SOFC) and the production of substitute natural gas (SNG) and Fischer–Tropsch liquids have been conducted. [43]

7 Conclusions

Biomass gasification technology has wide feedstock basis and high-quality end products can be obtained from the process. The product gas can be either combusted in gas-fired boilers to generate heat and electricity or in gas turbines or fuel cells for more efficient utilization. Fuels and chemicals can also be produced via synthesis and reforming reactions.

Fluidized bed technology is considered as the preferred technology in nearly all medium-to-large scale biomass gasification plants for power production. It can handle high throughput, it has good up-scaling potential and it can tolerate big variations in biomass quality and particle size. Air is preferred as gasification agent for simple heat and power installations, while the more advanced systems generally require oxygen. Pressurized gasification systems are considered for larger capacity installations as well as for IGCC and fuel and chemical production. [5]

Biomass gasification is considered as a CO₂ neutral way to produce power, fuels and chemicals. In this regard, it has many advantages over coal based technology. However, the advantages might not be significant enough when biomass gasification is compared to combustion in power generation applications — keeping in mind the more complex equipment that is necessary.

The gasification of biomass is not yet widely applied and the technology itself is under development. The main challenges are tar reduction, gas cleaning and scaling up the technology. Also the gasification technologies have to become more economically competitive to challenge the rivaling methods. [5]

A lot is expected on biomass gasification, and it has potential to become one of the leading technologies in clean and environmentally friendly power, fuel and chemical production. Nevertheless, more research and development is needed and possibly policies to encourage the usage of new environmentally friendly technologies.

Bibliography

- [1] Christopher Higman and Maarten van der Burgt. *Gasification*. Elsevier Inc., 2008.
- [2] H. E. M. Stassen and H. A. M. Knoef. Small-scale gasification systems. Technical report, University of Twente, Biomass Technology Group, The Netherlands, 1993.
- [3] Mark E. Dry. The Fischer–Tropsch process: 1950–2000. *Catalysis Today*, 71(3–4):227–241, 2002.
- [4] FundingUniverse. Sasol Limited Company History. <http://www.fundinguniverse.com/company-histories/Sasol-Limited-Company-History.html>, March 8 2011.
- [5] Arjan F. Kirkels and Geert P.J. Verbong. Biomass gasification: Still promising? A 30-year global overview. *Renewable and Sustainable Energy Reviews*, 15(1):471–481, 2011.
- [6] M. Morris and L. Waldheim. Energy recovery from solid waste fuels using advanced gasification technology. *Waste Management*, 18(6–8):557–564, 1998.
- [7] Henrik Ryti, editor. *Tekniikan käsikirja 2*. Gummerus, Jyväskylä, 1967.
- [8] Esa Kurkela. VTT:n kaasutusteknologian T&K v. 2011. Presentation on VTT gasification R&D, Aalto University, February 2011.
- [9] Stanislav V. Vassilev, David Baxter, Lars K. Andersen, and Christina G. Vassileva. An overview of the chemical composition of biomass. *Fuel*, 89(5):913–933, 2010.
- [10] A. van der Drift, J. van Doorn, and J. W. Vermeulen. Ten residual biomass fuels for circulating fluidized-bed gasification. *Biomass and Bioenergy*, 20(1):45–56, 2001.
- [11] L. E. Fryda, K. D. Panopoulos, and E. Kakaras. Agglomeration in fluidised bed gasification of biomass. *Powder Technology*, 181(3):307–320, 2008.

- [12] Antero Moilanen, Muhammad Nasrullah, and Esa Kurkela. The effect of biomass feedstock type and process parameters on achieving the total carbon conversion in the large scale fluidized bed gasification of biomass. *Environmental Progress & Sustainable Energy*, 28(3):355–359, 2009.
- [13] Antero Moilanen. Characterization of fuels for co-gasification of coal, biomass and waste and modeling aspects of fluidised bed gasification. FLEXGAS international workshop of co-gasification of coal, biomass and waste, Ciemat, Madrid, November 12–13 2009.
- [14] Maria Puig-Arnavat, Joan Carles Bruno, and Alberto Coronas. Review and analysis of biomass gasification models. *Renewable and Sustainable Energy Reviews*, 14(9):2841–2851, 2010.
- [15] Esa Kurkela. Kaasutustekniikat. Presentation on gasification technologies, Aalto University, February 2011.
- [16] Lijun Wang, Curtis L. Weller, David D. Jones, and Milford A. Hanna. Contemporary issues in thermal gasification of biomass and its application to electricity and fuel production. *Biomass and Bioenergy*, 32(7):573–581, 2008.
- [17] H. Kitzler, C. Pfeifer, and H. Hofbauer. Pressurized gasification of woody biomass — variation of parameter. *Fuel Processing Technology*, 92(5):908–914, 2011.
- [18] Peter Quaak, Harrie Knoef, and Hubert Stassen. Energy from Biomass — A Review of Combustion and Gasification Technologies. Technical Paper 422, World Bank, Washington, D.C., 1999.
- [19] Wood gas as engine fuel. FAO Forestry Paper 72, Food and Agriculture Organization of the United Nations, 1986.
- [20] Esa Kurkela. Review of Finnish biomass gasification technologies. OPET Report 4, OPET Finland, 2002.
- [21] Mustafa Balat, Mehmet Balat, Elif Kirtay, and Havva Balat. Main routes for the thermo-conversion of biomass into fuels and chemicals. part 2: Gasification systems. *Energy Conversion and Management*, 50(12):3158–3168, 2009.
- [22] José Corella, María-Pilar Aznar, Javier Gil, and Miguel A. Caballero. Biomass Gasification in Fluidized Bed: Where To Locate The Dolomite To Improve Gasification? *Energy & Fuels*, 13(6):1122–1127, 1999.

- [23] F. Miccio, B. Piriou, G. Ruoppolo, and R. Chirone. Biomass gasification in a catalytic fluidized reactor with beds of different materials. *Chemical Engineering Journal*, 154(1–3):369–374, 2009. XVIII International Conference on Chemical Reactors — CHEMREACTOR-8, Malta, September 29 – October 3, 2008.
- [24] PennWell Corporation. Danish biomass gasification — Co-generation & On-Site Power Production. <http://www.powergenworldwide.com/index/display/articledisplay/357189/articles/cogeneration-and-on-site-power-production/volume-10/issue-1/features/danish-biomass-gasification.html>, March 27 2011.
- [25] Lahti Energia Oy. Kymijärven voimalaitos. <http://www.lahtienergia.fi/lahti-energia/energian-hankinta-ja-tuotanto/50>, March 26 2011.
- [26] Timo Eriksson. The gasification solution. <http://www.powergenworldwide.com/index/display/articledisplay/193156/articles/power-engineering-international/volume-11/issue-10/features/the-gasification-solution.html>, March 27 2011.
- [27] Jörgen Held, editor. *International Seminar on Gasification 2009*. Svenskt Gastekniskt Center, 2009.
- [28] Chanchal Loha, Pradip K. Chatterjee, and Himadri Chattopadhyay. Performance of fluidized bed steam gasification of biomass — Modeling and experiment. *Energy Conversion and Management*, 52(3):1583–1588, 2011.
- [29] Jinsong Zhou, Qing Chen, Hui Zhao, Xiaowei Cao, Qinfeng Mei, Zhongyang Luo, and Kefa Cen. Biomass-oxygen gasification in a high-temperature entrained-flow gasifier. *Biotechnology Advances*, 27(5):606–611, 2009. Bioenergy Research & Development in China — ICBT 2008.
- [30] Lopamudra Devi, Krzysztof J. Ptasinski, and Frans J. J. G. Janssen. A review of the primary measures for tar elimination in biomass gasification processes. *Biomass and Bioenergy*, 24(2):125–140, 2003.
- [31] Pia Oesch, Eero Leppämäki, and Pekka Ståhlberg. Sampling and characterization of high-molecular-weight polyaromatic tar compounds formed in the pressurized fluidized-bed gasification of biomass. *Fuel*, 75(12):1406–1412, 1996.
- [32] Jun Han and Heejoon Kim. The reduction and control technology of tar during biomass gasification/pyrolysis: An overview. *Renewable and Sustainable Energy Reviews*, 12(2):397–416, 2008.

- [33] X. T. Li, J. R. Grace, C. J. Lim, A. P. Watkinson, H. P. Chen, and J. R. Kim. Biomass gasification in a circulating fluidized bed. *Biomass and Bioenergy*, 26(2):171–193, 2004.
- [34] Keith R. Cummer and Robert C. Brown. Ancillary equipment for biomass gasification. *Biomass and Bioenergy*, 23(2):113–128, 2002.
- [35] Dahlman. Excellence in Gas Purification. <http://www.renewableenergy.nl/>, March 30 2011.
- [36] Ron Zevenhoven and Pia Kilpinen. *Control of pollutants in flue gases and fuel gases*. Helsinki University of Technology, Espoo, 2001.
- [37] Andritz AG. Gasification. <http://www.andritz.com/ANONID21DB1B726D03CE4C/gasification>, April 2 2011.
- [38] Envirotherm GmbH. CFB Circulating Fluidized Bed. http://envirotherm.de/content/e39/e137/e43/index_eng.html, April 2 2011.
- [39] Rentech, Inc. Gasification. <http://rentechinc.com/silvaGas.php>, April 2 2011.
- [40] CHOREN Industries GmbH. Carbo-V®. <http://www.choren.com/en/carbo-v/>, April 2 2011.
- [41] LahtiStreams. Advanced Integrated Waste Management and WtE Demonstration. <http://www.lahtistreams.com/>, April 3 2011.
- [42] Lahti Energia Oy. KYVO2 — Roskat energiaksi. <http://www.roskatenergiaksi.fi/>, April 3 2011.
- [43] Reinhard Rauch. The FICFB-gasification system. <http://www.ficfb.at/>, April 2 2011.